

**MM75**

**6547** - USM751\_2

 **DANGER**

**To avoid shock hazard:**

- Do not remove the covers.
- Do not operate this product unless the stand is attached.
- Do not connect or disconnect this product during an electrical storm.
- The power cord plug must be connected to a properly wired and grounded power outlet.
- Any equipment to which this product will be attached must also be connected to properly wired and grounded power outlets.
- To isolate the monitor from the electrical supply, you must remove the plug from the power outlet. The power outlet should be easily accessible.

**Handling:**

- Your monitor is heavy, so handle it with care. If heavier than 18Kg, IBM recommends that the monitor is moved or lifted by two people.

 **DANGER**

**Pour éviter les risques d'électrocution :**

- Ne retirez pas les capots du moniteur.
- N'utilisez pas ce produit si le socle n'est pas fixé.
- Ne connectez, ni ne déconnectez ce produit pendant un orage.
- Le câble d'alimentation doit être connecté à une prise électrique correctement mise à la terre et en bon état de marche.
- Tout équipement auquel ce produit est relié doit être également connecté à une prise correctement mise à la terre et en bon état de marche.
- Pour isoler le moniteur de la source d'alimentation électrique, vous devez le débrancher de la prise électrique. Cette prise doit être facile d'accès.

**Manutention :**

- Votre moniteur couleurs est lourd. Vous devez le manipuler avec soin. Si votre moniteur pèse plus de 18 kg, IBM vous recommande de demander l'aide d'une autre personne pour le déplacer ou le soulever.

 **PELIGRO**

**Para evitar riesgos de descargas eléctricas:**

- No retire bajo ningún concepto las cubiertas.
- No trabaje con el monitor sin antes acoplar el soporte.
- No conecte ni desconecte el equipo de una toma de alimentación durante una tormenta eléctrica.
- El cable de alimentación debe estar conectado a un enchufe debidamente cableado y con toma de tierra.
- Cualquier equipo al que se vaya a conectar este producto también debe estar conectado a tomas de alimentación cableadas y conectadas a tierra correctamente.
- Para aislar el monitor del suministro eléctrico, debe retirar el enchufe de la toma de alimentación. Esta toma deberá ser de fácil acceso.

**Manipulación:**

- El monitor de color es pesado, por lo que debe manipularlo con cuidado. Si pesa más de 18 kg, IBM recomienda moverlo con la ayuda de dos personas.

 **PERIGO**

**Para evitar o risco de choque elétrico:**

- Não remova as coberturas.
- Não acione este produto a menos que o apoio esteja conectado.
- Não conecte ou desconecte este produto durante uma tempestade elétrica.
- O cabo de corrente deve estar conectado a uma tomada elétrica aterrada, cuja fiação seja apropriada.
- Todos os equipamentos aos quais este produto for conectado também deverão estar conectados a tomadas elétricas com fiação adequada.
- Para isolar o monitor do fornecimento de eletricidade, você deve remover o plugue da tomada. Esta deve estar o mais perto possível do monitor, em local de fácil acesso.

**Manuseio:**

- Seu monitor colorido é pesado, então manuseie-o com cuidado. Se o peso for superior a 18 (dezoito) Kg., a IBM recomenda que o monitor seja movido ou carregado por duas pessoas.

ENGLISH

# English

---

## Edition 1 (June 1997)

This publication could contain technical inaccuracies or typographical errors. Changes are made periodically to the information herein; these changes will be made in later editions. IBM may make improvements and/or changes in the product(s) and/or program(s) at any time.

It is possible that this publication may contain reference to, or information about, IBM products (machines and programs), programming, or services that are not announced in your country.

Requests for copies of this publication and for technical information about IBM products should be made to your IBM Authorized Dealer, IBM Retailer.

No part of this publication may be reproduced or distributed in any form or by any means without prior permission in writing from the International Business Machines Corporation.

© Copyright International Business Machines Corporation 1997. All rights reserved.

---

## Notices

References in this publication to IBM products, programs, or services do not imply that IBM intends to make these available in all countries in which IBM operates. Any reference to an IBM product, program or service is not intended to state or imply that only IBM's product, program, or service may be used. Any functionally equivalent product, program, or service that does not infringe any of IBM's intellectual property rights or other legally protectable rights may be used instead of the IBM product, program, or service. Evaluation and verification of operation in conjunction with other products, programs, or services, except those expressly designated by IBM, are the user's responsibility.

IBM may have patents or pending patent applications covering subject matter in this document. The furnishing of this document does not give you any license to these patents.

---

## Trademarks

The following terms, used in this publication, are trademarks or service marks of the IBM Corporation in the United States or other countries: IBM Aptiva HelpCenter

ENERGY STAR is a U.S. registered mark

TrueSpace is a trademark of Bose

# Contents



Setup .....	2
User Controls .....	8
Audio Support .....	12
Further Information .....	13
Specifications .....	15
Troubleshooting .....	17

# Setup

---

## Your MM75 Color Monitor

The MM75 attaches only to Aptiva S Series Personal Computers machine type 2142 and Aptiva L Series Personal Computers, machine type 2140. These multimedia monitors are an integrated part of the Bose TrueSpace™ sound system and it is essential that these monitors and system units be used together.

---

## Workplace Preparation



*This section gives advice on the things that you should consider before you set up your monitor.*

### Positioning the Monitor

Choose a suitable place to position the monitor where it is not near fluorescent desk lighting or any equipment that produces magnetic fields that could cause interference. Ensure that the furniture or equipment can support the weight of the monitor. Allow at least 2 inches (50mm) ventilation space around the monitor.

### Height

The monitor should be positioned so that the top of the screen is slightly below your eye level when you sit at your workstation.

### Orientation

Choose a position that gives the least reflection from lights and windows, usually at a right angle to any windows. The monitor should be positioned directly in front of you so that you do not have to twist your body. Tilt the monitor to a comfortable viewing angle.

## Working Practices

*i*

*This section gives advice on how you can reduce fatigue and work comfortably.*

### **Rest**

Take regular breaks. Vary your posture, and stand up and stretch occasionally as prolonged use of computer workstations can be tiring.

### **Back**

You should sit back in the chair and use the backrest.

### **Hands**

Use a light touch on the keyboard, keeping your hands and fingers relaxed. Allow a space in front of the keyboard to rest your wrists when not typing. Consider using a wristpad.

### **Eyesight**

Working with monitors, in common with any prolonged close work, can be visually demanding. Look away from the screen periodically and have your eyesight checked regularly.

### **Screen settings**

Set the screen brightness and contrast to a comfortable level. You may have to adjust this as the lighting changes during the day. Many application programs let you select color combinations which can help you to view in comfort.



## Attaching the stand



*Do not operate the monitor until the stand is fully assembled, according to the instructions in this section.*

### Fitting the base

1 Place monitor on a stable surface as shown below.

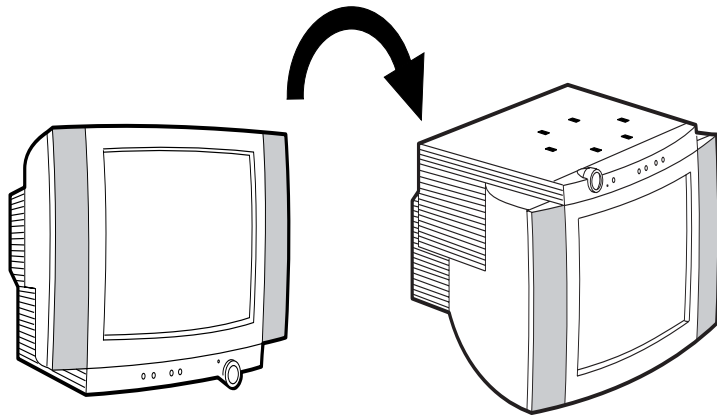

2 Insert the 6 hooks into the matching slots on the underside of the monitor.

3 Slide the base towards the front of the monitor until the latch clicks into the locked position.

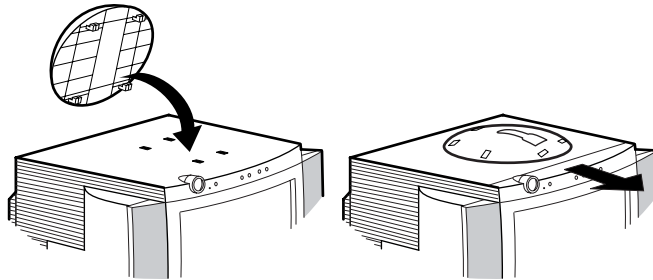

### Fitting the Aptiva L Series Tilt/Swivel Stand

**i**  
For Aptiva L series computers.

- 1 Align the stand interface with the monitor as shown in the diagram so that the horseshoe connector fits into the matching slot in the bowl.

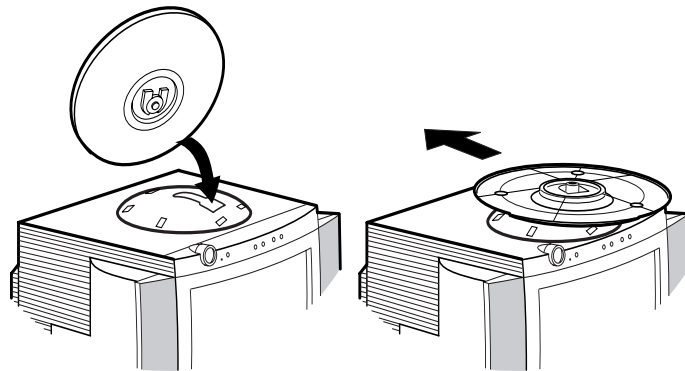

- 2 Push the stand back until you hear a loud click which shows it is locked in place.
- 3 Turn the stand 90° counter clockwise until the notch points to the front of the monitor.

**i**  
The stand interface is not required for Aptiva L series computers.

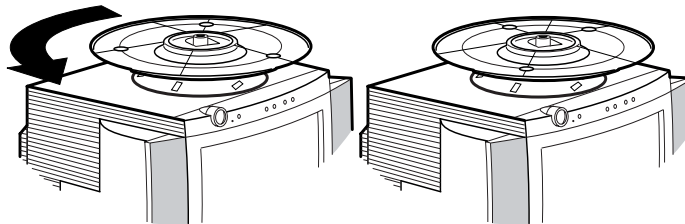

*i*  
For Aptiva S series computers.

### Fitting the Aptiva S series stand

- 1 Align the stand interface with the monitor as shown in the diagram so that the horseshoe connector fits into the matching slot in the bowl.
- 2 Push the interface back until you hear a loud click which shows it is locked in place.

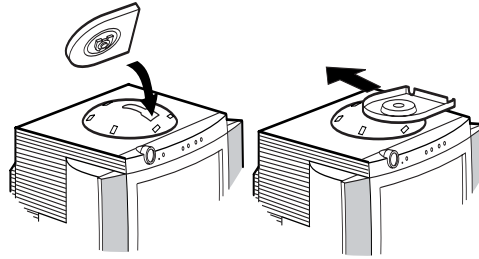

- 3 Turn the interface 90° counter clockwise as shown in the next diagram.

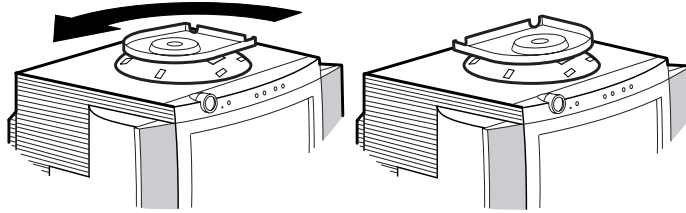

*i*  
Your monitor is designed to sit on a stand which is packed in the box containing your Aptiva S series computer. The interface for this stand is packed with the monitor.

- 4 Unpack the tubular stand from the box containing your Aptiva S series computer.

- 5 Position the stand as shown in the diagram and push firmly until it clicks into place.

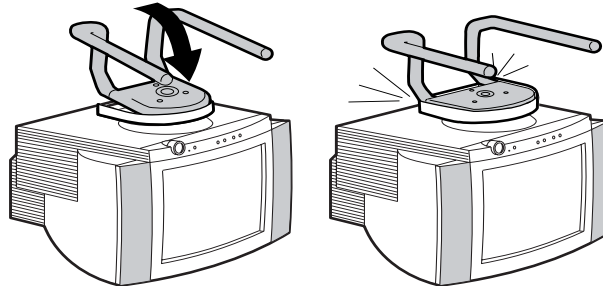

*i*  
The tilt/swivel stand is not required for Aptiva S series computers.

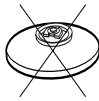





## Connecting your monitor



*Before connecting the monitor, turn off the computer and attached devices.*



*Ensure the power at the electrical outlet matches the power requirements of the monitor. Refer to the **Specifications** section on page 15 for more details.*

- 1 Plug the video signal cable connector (blue) into the socket marked  on your computer.
- 2 Plug the USB connector (green) into the socket marked  on your computer.
- 3 Plug the speaker connector (violet) into the socket marked  on your computer.
- 4 Plug the microphone connector (orange) into the socket marked  on your computer.
- 5 Connect the power cord to the monitor first, then firmly insert the plug into a properly grounded electrical outlet.
- 6 Turn on the monitor, and then the computer.

If your monitor does not seem to be working correctly, refer to the **Troubleshooting** section on page 17.



*For ease of installation, the sockets on the rear of your Aptiva 214X series computer are color coded to match the connectors on the monitor signal cable.*

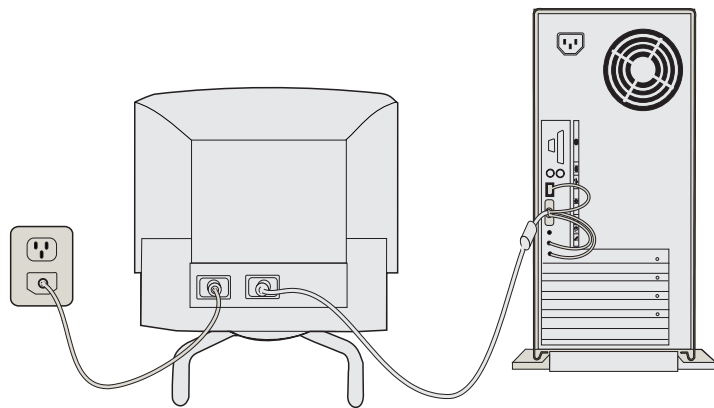

# User Controls

## Location of controls

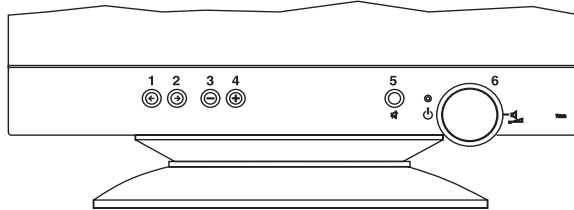

Button	Description	Function
1	Select	Scroll left through controls
2	Select	Scroll right through controls
3	Adjust ( - )	Decrease
4	Adjust ( + )	Increase
5	Audio Mute	Cuts the sound from all speakers and temporarily displays the mute symbol on the OSD. Press again to restore sound.
6	Volume and Power	Rotate to adjust sound level Push to switch on and off

*i*  
When sound is muted via the monitor mute button, it can be restored by increasing the volume using the rotary volume control.

*i*  
The image is already optimized for many display modes, however the user controls can be used to adjust the image to your liking.

## On Screen Display (OSD)

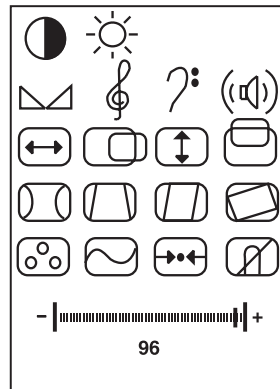





































***i***

To display the OSD, press button 1 or 2. When the menu is displayed on the screen, you can then select a control using buttons 1 or 2. When the required control is highlighted, use buttons 3 and 4 to adjust the control.

***i***

The audio symbols shown are dependent on your system hardware setup. Refer to the Audio Support section on page 12 for details.

Control		Adjust (-)	Adjust (+)
	Contrast		
	Brightness		
	Balance	More sound from the left speaker	More sound from the right speaker
	Treble	Decreases high frequency response	Increases high frequency response
	Bass	Decreases low frequency response	Increases low frequency response
	Fade	More sound from the monitor speakers	More sound from the separate rear speakers
	Horizontal Size		
	Horizontal Position		
	Vertical size		

Control		Adjust (-)	Adjust (+)
	Vertical position		
	Pincushion		
	Trapezoid		
	Parallelogram		
	Rotation		
	Color Temperature	Select between 6500K, 7200K and 9300K to alter the color point.	
	Current Frequency	Current Frequency displays the current horizontal and vertical signal frequency that the monitor is receiving. This is an informational screen only.	
	Recall	Push and hold the + button for three seconds to recall the original factory settings, if any, for the current display mode.	

***i***  
 Recall operation resets all of the data in the user memory area for the current display mode.



*Discoloration of the image can be caused by gradual magnetization of the monitor components. This is particularly likely to occur when the monitor has been moved or rotated.*



*Do not highlight the degauss symbol and then press the + button for longer than 5 seconds. If you do, this operation resets all of the data in the user memory area. If this occurs, you must re-enter your user adjustments.*

Control		Adjust (-)	Adjust (+)
	Degauss		Push the + button once to remove screen color impurities caused by magnetic fields. The monitor may “buzz” momentarily and the image will change color and wobble for a few seconds. These effects are normal. Do not use the degauss feature more than once within a 30 minute period



# Audio Support

## Supported Audio Function



Your Multimedia monitor has two built-in speakers that are designed to complement the audio amplifier contained in the Aptiva L and S series computers.



If you use this monitor with a system other than an Aptiva 214X series computer there is no supported audio function.



Monitor Audio Controls may not work in DOS modes, including games.



The built-in microphone offers the possibility of voice control of applications including telephony.



The audio functions can also be adjusted via software programs. Please see your computer documentation for further information.

If your Aptiva computer carton contains:	Available Functions
--	---------------------

No Subwoofer	Volume, Balance.
Subwoofer	Volume, Balance, Bass, Treble.
Subwoofer and separate rear speakers	Volume, Balance, Bass, Treble and Fade.

The most common Audio functions are described in **User Controls** section on page 8.

Other functions are available as shown below:

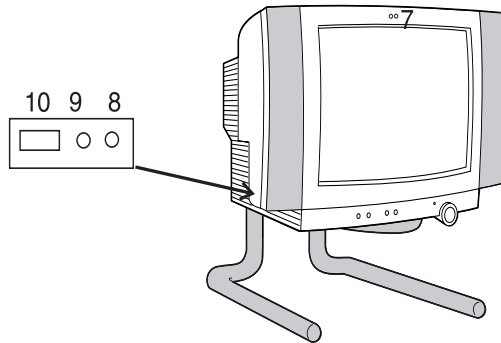

Item	Description	Function
7	Built in microphone	Voice input.
8	External Microphone connection	When an external microphone is connected, the internal microphone is disabled.
9	Headphone socket	When headphones are connected, all other speakers are disabled.
10	USB socket	Any Universal Serial Bus peripherals.

# Further Information

## Display Modes

The display mode the monitor uses is controlled by the computer. Therefore, you should refer to your computer documentation for details on how to change display modes.

The image size, position and shape may change when the display mode changes. This is normal and the image can be readjusted using the monitor controls.

To ensure flicker-free operation, select the highest (non-interlaced) refresh rate both the computer and the monitor can support, (generally 75 Hz or higher), for the addressability that your application requires.

For the display modes listed below, the screen image has been optimized during manufacture.

Addressability	Refresh Rate	Horizontal Frequency
720 x 400	70 Hz	31.5 kHz
720 x 400	85 Hz	37.9 kHz
640 x 480	60 Hz	31.5 kHz
640 x 480	85 Hz	43.3 kHz
800 x 600	60 Hz	37.9 kHz
800 x 600	85 Hz	53.7 kHz
1024 x 768	60 Hz	48.4 kHz
1024 x 768	75 Hz	60.0 kHz
1024 x 768	85 Hz	68.7 kHz

***i***  
 1024 x 768 at 85 Hz is the recommended display mode.

## Power Management



*To benefit from power management, the monitor must be used in conjunction with a computer that implements the Video Electronics Standards Association (VESA) Display Power Management Signalling (DPMS) Standard.*

The power management feature is invoked when the computer recognizes that you have not used your mouse or keyboard for a user-definable period of time. There are several states as described in the table below.

As an ENERGY STAR Partner, IBM has determined that this product meets ENERGY STAR guidelines for energy efficiency.



*After the monitor is switched off, audio may still be present from the speakers if your Aptiva computer is left switched on.*

State	Power Indicator	Screen	Restoring Operation	Compliance
On	Steady green	Normal		
VESA Standby	Steady orange	Blank	Press a key or move the mouse.	
VESA Suspend	Flashing orange / green	Blank	Press a key or move the mouse.‡	ENERGY STAR
VESA Off	Flashing orange	Blank	Press a key or move the mouse.‡	ENERGY STAR NUTEK

‡ There may be a slight delay before the picture returns.

# Specifications

***i***  
 The MM75 color monitor uses a 17 inch FST CRT with a viewable image size of 15.7 inches (399 mm).

Machine Type		2128
Dimensions	Width: Depth: Height: With tilt/swivel stand: With tubular stand:	520 mm (20.5 inch) 441 mm (17.4 inch) 422.5 mm (16.6 inch) 538.5 mm (21.2 inch)
Weight	With tilt/swivel stand: With tubular stand:	20.5 Kg (45.1 lb) 21.8 Kg (46.6 lb)
Tilt Swivel	Forward tilt: Backward tilt: Swivel:	4.5° 12° ± 90°
Image	Maximum height: Maximum width: Dot pitch:	240 mm (9.4 inch) 320 mm (12.6 inch) 0.28 mm
Power	Supply voltage: Max supply current:	90 - 264 Vac 50 / 60 ±3 Hz 1.5A at 120 Vac
Power Consumption (Typical)	Normal operation: VESA standby: VESA suspend: VESA off:	100 W 55 W 15 W <8 W
Synchronization Range	Horiz. frequency: Vert. frequency:	30 kHz - 69 kHz 50 Hz - 160 Hz
Video	Input Signal: Horiz. addressability: Vert. addressability: Clock rate:	Analog Direct Drive, 75 ohm 0-0.7v 1280 pels (max.) 1024 lines (max.) 110 Mpels/sec
Audio Input	Integrated microphone: External jack	Telex Clair

Audio Output	Integrated stereo speakers: Headphone jack	Bose
Communications	VESA DDC	1 /2 B
Environment	Temperature: Operating: Storage: Shipping:	0 to 40° C -20 to 60° C -40 to 65° C
	Humidity: Operating: Storage: Shipping:	10 to 80% 5 to 95% 5 to 95%
	Emissions	MPR-II

# Troubleshooting

*i*

If you have a problem setting up or using your monitor, you may be able to solve it yourself. Before calling your retailer or IBM try the suggested actions that are appropriate to your problem.

Problem	Possible Cause	Suggested Action	Reference
Screen is blank and power indicator is off.	No power to monitor.	Ensure that the electrical outlet and the monitor are both switched on. Check that the power cord is firmly plugged into the monitor and the electrical outlet. If the power cord plug has a removable fuse, replace it. Try another power cord. Try another electrical outlet.	<b>Connecting your monitor</b> on page 7
Screen is blank and power indicator is steady green.	Brightness and Contrast may be too low.	Adjust brightness and contrast.	<b>User Controls</b> on page 8
Screen is blank and power indicator is steady orange, flashing orange/green or flashing orange.	Display mode of the computer is outside the range of the monitor.	Reconfigure the computer to use a supported display mode.	<b>Further Information</b> on page 13
	The monitor is in the Power Management Standby, Suspend or Off state.	Press any key on the keyboard or move the mouse to restore operation. Check the Power Management software on your computer. Ensure the computer is switched on.	<b>Further Information</b> on page 13
	The monitor is working but there is a problem with the signal cable.	Check that the video signal cable is firmly connected to the computer. Check that no pins are bent in the signal cable connector.	<b>Connecting your monitor</b> on page 7

Problem	Possible Cause	Suggested Action	Reference
Image appears to be flickering.	The monitor is operating in an interlaced or low refresh rate display mode.	Reconfigure the computer to use a non-interlaced display mode with a refresh rate of at least 75 Hz. 85 Hz is recommended.	See <b>Further Information</b> on page 13
	The monitor may be affected by interference from nearby equipment.	Move fluorescent desk lighting or any equipment that produces magnetic fields further away from the monitor.	
	The computer was switched on before the monitor.	Shut down your computer and restart it. Leave your monitor switched on.	
Image appears to be discolored.	The monitor may be affected by interference from nearby equipment.	Move any equipment that produces magnetic fields (e.g. sub woofer speakers) further away from the monitor.	
		If another monitor is close by, a separation distance of at least 6 inches (150 mm) is recommended.	
	Magnetization of monitor components has built up.	Degauss the monitor.	See <b>User Controls</b> on page 8
	Incorrect color temperature selected	Select an alternative color temperature.	See <b>User Controls</b> on page 8

Problem	Possible Cause	Suggested Action	Reference
No Sound	Current program does not use sound	None.	
	Volume set too low	Increase the volume using the rotary volume control or OSD.	
	The sound may be muted	Press button 5 once or adjust the rotary volume control.	See <b>User Controls</b> on page 8
		If the sound was muted via a software program, you must use this again to restore sound.	
	No audio signal from the computer	Check the audio cables have been properly connected to the computer.	See <b>Connecting your monitor</b> on page 7
	Faulty audio system in the computer.	Have the computer audio system checked out.	
Sound seems distorted	Volume set too high	Decrease volume using the volume rotary control.	
Sound from only one speaker	Incorrect balance setting	Adjust using OSD balance control.	See <b>User Controls</b> on page 8
No sound symbols in the OSD	The Aptiva sound system is not in use	Activate the Aptiva sound system program	See your <i>Computer System</i> Documentation
	The monitor is not attached to an Aptiva L or S series computer.		
Sound controls not working	Computer is running an application which is not supported by the Aptiva Sound System, such as a DOS program.		
Sound coming from speakers after monitor has been switched off	Audio program is still running in the computer		



## Monitor Self Diagnosis

The monitor continuously checks for the presence of a signal cable. If the cable is disconnected, the monitor displays a low intensity full white screen. If you see this screen the monitor is working properly. If you do not see this screen and all troubleshooting remedies do not resolve the problem, further help will be required from an IBM authorized dealer/retailer or from an IBM HELPCENTER.

## Further Help

If you are unable to correct the problem yourself, you may seek further help as follows:

Call IBM HELPCENTER.

In the US call 1-800-772-2227

In Canada call 1-800-565-3344

In other countries contact your dealer, retailer, or other IBM authorized Servicer.

Before calling, please have available as much of the following information as possible:

- 1 Model and serial number from the label on the back of your monitor.
- 2 Purchase receipt.
- 3 Description of problem.
- 4 Computer type and model.
- 5 System configuration (hardware fitted, etc.).
- 6 System BIOS version number.
- 7 Operating System and version number.
- 8 Display driver version number.



*If possible, stay by your computer system. Your technical support representative might want to go through the problem with you during the call.*

# Appendix

# Compliances

---

## Federal Communications Commission (FCC) Statement

This equipment has been tested and found to comply with the limits for a Class B digital device, pursuant to Part 15 of the FCC Rules. These limits are designed to provide reasonable protection against harmful interference in a residential installation. This equipment generates, uses, and can radiate radio frequency energy and, if not installed and used in accordance with the instructions, may cause harmful interference to radio communications. However, there is no guarantee that interference will not occur in a particular installation. If this equipment does cause harmful interference to radio or television reception, which can be determined by turning the equipment off and on, the user is encouraged to try to correct the interference by one or more of the following measures:

- Reorient or relocate the receiving antenna.
- Increase the separation between the equipment and receiver.
- Connect the equipment into an outlet on a circuit different from that to which the receiver is connected.
- Consult an IBM authorized dealer or service representative for help.

Properly shielded and grounded cables and connectors must be used in order to meet FCC emission limits. Proper cables and connectors are available from IBM authorized dealers. IBM is not responsible for any radio or television interference caused by using other than recommended cables and connectors or by unauthorized changes or modifications to this equipment. Unauthorized changes or modifications could void the user's authority to operate the equipment.

This device complies with Part 15 of the FCC Rules. Operation is subject to the following two conditions: (1) this device may not cause harmful interference, and (2) this device must accept any interference received, including interference that may cause undesired operation.

---

## Industry Canada Compliance Statement

This Class B digital apparatus meets the requirements of the Canadian Interference-Causing Equipment Regulations. Cet appareil numérique de la classe B respecte toutes les exigences du Règlement sur le matériel brouilleur du Canada.

---

## Nom

IBM de México, S.A.  
IBM MM75 Monitor de Color (M/T 7097)  
Planta de Manufactura  
416, Maetan-3Dong, Paldal-Gu  
Suwon City, Kyungki-Do, Korea  
442-742  
Hecho en Korea  
**NOM - 018**  
Consumo de Corriente 1.5 A  
Frecuencia de Operacion 50/60 Hz  
Rension de Alimentacion 100-240 V

---

## Power Cords

For your safety, IBM provides a power cord with a grounded attachment plug to use with this IBM product. To avoid electrical shock, always use the power cord and plug with a properly grounded power outlet. IBM power cords used in the United States and Canada are listed by the Underwriters Laboratories (UL) and certified by the Canadian Standards Association (CSA).

For units intended to be operated at 115 volts: Use a UL listed and CSA certified cord set consisting of a minimum 18 AWG, type SVT or SJT, three conductor cord, a maximum of 4.5 meters (15 feet) in length and a parallel blade, grounding type attachment plug rated 15 amperes, 125 volts.

For units intended to be operated at 230 volts (U.S. use): Use a UL listed and CSA certified cord set consisting of a minimum 18 AWG, type SVT or SJT, three conductor cord, a maximum of 4.5 meters (15 feet) in length and a tandem blade, grounding type attachment plug rated 15 amperes 250 volts.

For units intended to be operated at 230 volts (outside the U.S.): Use a cord set with a grounding type attachment plug rated 13 amperes (minimum), 250 volts. The cord set should be marked <HAR> and have the appropriate safety approvals for the country in which the equipment will be installed.

# Warranty

## Statement of Limited Warranty

The warranties provided by IBM in this Statement of Limited Warranty apply only to Machines you originally purchase for your use, and not for resale, from IBM or your reseller. The term "Machine" means an IBM machine, its features, conversions, upgrades, elements, or accessories, or any combination of them. Unless IBM specifies otherwise, the following warranties apply only in the country where you acquire the Machine. If you have any questions, contact IBM or your reseller.

<b>Machine:</b>	6547
<b>Warranty Period*:</b>	1 year.
* Contact your place of purchase for warranty service information	

### Production Status

Each Machine is manufactured from new parts, or new and used parts. In some cases, the Machine may not be new and may have been previously installed. Regardless of the Machine's production status, IBM's warranty terms apply.

### The IBM Warranty for Machines

IBM warrants that each Machine 1) is free from defects in materials and workmanship and 2) conforms to IBM's Official Published Specifications. The warranty period for a Machine is a specified, fixed period commencing on its Date of Installation. The date on your receipt is the Date of Installation, unless IBM or your reseller informs you otherwise. During the warranty period IBM or your reseller, if authorized by IBM, will provide warranty service under the type of service designated for the Machine and will manage and install engineering changes that apply to the Machine. For IBM or your reseller to provide warranty service for a feature, conversion, or upgrade, IBM or your reseller may require that the Machine on which it is installed be 1) for certain Machines, the designated, serial-numbered Machine and 2) at an engineering-change level compatible with the feature, conversion, or upgrade. Many of these transactions involve the removal of parts and their return to IBM. You represent that all removed parts are genuine and unaltered. A part that replaces a removed part will assume the warranty service status of the replaced part. If a Machine does not function as warranted during the warranty period, IBM or your reseller will repair it or replace it with one that is at least functionally equivalent, without charge. The replacement may not be new, but will be in good working order. If IBM or your reseller is unable to repair or replace the Machine, you may return it to your place of purchase and your money will be refunded. If you transfer a Machine to another user, warranty service is available to that user for the remainder of the warranty period. You should give your proof of purchase and this Statement to that user. However, for Machines which have a life-time warranty, this warranty is not transferable.

### Warranty Service

To obtain warranty service for the Machine, you should contact your reseller or call IBM. In the United States, call IBM at 1-800-772-2227. In Canada, call IBM at 1-800-565-3344. You may be required to present proof of purchase. IBM or your reseller will provide certain types of repair and exchange service, either at your location or at IBM's or your reseller's service center, to restore a Machine to good working order. When a type of service involves the exchange of a Machine or part, the item IBM or your reseller replaces becomes its property and the replacement becomes yours. You represent that all removed items are genuine and unaltered. The replacement may not be new, but will be in good working order and at least functionally equivalent to the item replaced. The replacement assumes the warranty service status of the replaced item. Before IBM or your reseller exchanges a

Machine or part, you agree to remove all features, parts, options, alterations, and attachments not under warranty service. You also agree to ensure that the Machine is free of any legal obligations or restrictions that prevent its exchange.

You agree to:

- 7 obtain authorization from the owner to have IBM or your reseller service a Machine that you do not own; and
- 8 where applicable, before service is provided -
  - a follow the problem determination, problem analysis, and service request procedures that IBM or your reseller provide,
  - b secure all programs, data, and funds contained in a Machine, and
  - c inform IBM or your reseller of changes in a Machine's location.

IBM is responsible for loss of, or damage to, your Machine while it is 1) in IBM's possession or 2) in transit in those cases where IBM is responsible for the transportation charges.

### **Extent of Warranty**

IBM does not warrant uninterrupted or error-free operation of a Machine.

The warranties may be voided by misuse, accident, modification, unsuitable physical or operating environment, improper maintenance by you, removal or alteration of Machine or parts identification labels, or failure caused by a product for which IBM is not responsible.

THESE WARRANTIES REPLACE ALL OTHER WARRANTIES OR CONDITIONS, EXPRESS OR IMPLIED, INCLUDING, BUT NOT LIMITED TO, THE IMPLIED WARRANTIES OR CONDITIONS OF MERCHANTABILITY AND FITNESS FOR A PARTICULAR PURPOSE. THESE WARRANTIES GIVE YOU SPECIFIC LEGAL RIGHTS AND YOU MAY ALSO HAVE OTHER RIGHTS WHICH VARY FROM JURISDICTION TO JURISDICTION. SOME JURISDICTIONS DO NOT ALLOW THE EXCLUSION OR LIMITATION OF EXPRESS OR IMPLIED WARRANTIES, SO THE ABOVE EXCLUSION OR LIMITATION MAY NOT APPLY TO YOU. IN THAT EVENT SUCH WARRANTIES ARE LIMITED IN DURATION TO THE WARRANTY PERIOD. NO WARRANTIES APPLY AFTER THAT PERIOD.

### **Limitation of Liability**

Circumstances may arise where, because of a default on IBM's part or other liability you are entitled to recover damages from IBM. In each such instance, regardless of the basis on which you are entitled to claim damages from IBM (including fundamental breach, negligence, misrepresentation, or other contract or tort claim), IBM is liable only for:

1. damages for bodily injury (including death) and damage to real property and tangible personal property; and 2. the amount of any other actual direct damages or loss, up to the greater of U.S. \$100,000 or the charges (if recurring, 12 months' charges apply) for the Machine that is the subject of the claim.

UNDER NO CIRCUMSTANCES IS IBM LIABLE FOR ANY OF THE FOLLOWING: 1) THIRD-PARTY CLAIMS AGAINST YOU FOR LOSSES OR DAMAGES (OTHER THAN THOSE UNDER THE FIRST ITEM LISTED ABOVE); 2) LOSS OF, OR DAMAGE TO, YOUR RECORDS OR DATA; OR 3) SPECIAL, INCIDENTAL, OR INDIRECT DAMAGES OR FOR ANY ECONOMIC CONSEQUENTIAL DAMAGES (INCLUDING LOST PROFITS OR SAVINGS), EVEN IF IBM OR YOUR RESELLER IS INFORMED OF THEIR POSSIBILITY. SOME JURISDICTIONS DO NOT ALLOW THE EXCLUSION OR LIMITATION OF INCIDENTAL OR CONSEQUENTIAL DAMAGES, SO THE ABOVE EXCLUSION OR LIMITATION MAY NOT APPLY TO YOU.

---

## Service information

The following parts are use by IBM service, or IBM authorized dealers, to support the customer warranty. Parts are for service use only.

Part Number	M/T-Model	Description
60H9571	6547-B1N	UVNH
60H9600	6547-B1E	UVEQ
60H9601	6547-B1S	UVSH
60H9602	6547-D1N	JPN
60H9603		Tilt Swivel Base
60H9604		Stand Base
60H9573		Stand Interface
60H9575		Speaker Grills