

SixPakPlus
Memory Expansion and I/O Card
for the
IBM Personal Computer,
IBM PC-XT, and
Other IBM-Compatible Machines

User's Manual
Version 1.0
June, 1983

AST RESEARCH, INC.
2372 Morse Avenue, Irvine, California 92714
(714) 540-1333

FIRST EDITION (June, 1983)

IBM is a registered trademark of International Business Machines Corporation

Compaq is a trademark of Compaq Computers, Inc.

**SixPakPlus, SuperPak, SuperDrive, and SuperSpool are trademarks of
AST Research, Inc.**

**Copyright © 1983 AST Research, Inc. All rights are reserved, including those to
reproduce this book or parts thereof in any form without permission in writing from
AST Research, Inc.**

TABLE OF CONTENTS

SECTION 1 GENERAL OVERVIEW	1-1
1.1 Compatibility	1-1
1.2 Standard Features	1-2
1.3 Available Options	1-3
1.4 "Do I Really Need to Read This Manual?"	1-3
1.5 System Requirements: Non-PC-DOS Operation	1-4
1.6 SixPakPlus Board Layout	1-4
SECTION 2 SIXPAKPLUS MEMORY CONFIGURATION	2-1
2.1 SixPakPlus Memory Switch settings	2-1
2.1.1 SixPakPlus Starting Memory Address	2-2
2.1.2 Amount of Memory Installed on the SixPakPlus	2-3
2.1.3 Parity Check Enable	2-4
2.2 PC System Board Switch Configuration	2-4
2.2.1 PC-1 System Board Switch Settings	2-5
2.2.2 PC-2 System Board Switch Settings	2-6
2.2.3 PC-XT System Board Switch Settings	2-7
2.3 Installing Multiple Memory Cards	2-7
2.3.1 Installing a Card "Below" the SixPakPlus	2-8
2.3.2 Installing a Card "Above" the SixPakPlus	2-9
2.4 Installing Additional Memory on the SixPakPlus	2-9
2.5 Troubleshooting Memory Problems	2-11
SECTION 3 SERIAL PORT	3-1
3.1 Configuration of the SixPakPlus Serial Port	3-1
3.1.1 Installing Multiple Serial Ports in a PC	3-1
3.1.2 Configuring the RS-232C Interface Lines	3-1
3.1.3 Disabling the Serial Port	3-4
3.2 Programming the Serial Port	3-4
3.3 Serial I/O Port Assignments and Pinouts	3-5
3.4 Diagnostic Testing of the Serial Port	3-6

TABLE OF CONTENTS

(Continued)

SECTION 4 PARALLEL PRINTER PORT	4-1
4.1 Configuration of the SixPakPlus Parallel Port	4-1
4.1.1 Installing Multiple Parallel Ports in a PC	4-2
4.1.2 IBM Monochrome Display / Printer Adapter Card ..	4-2
4.1.3 Disabling the Parallel Port	4-2
4.2 Installing the Parallel Interface Cable	4-2
4.3 Programming the Parallel Port	4-3
4.4 Parallel Port I/O Assignments and Pinouts	4-4
4.5 Diagnostic Testing of the Parallel Port	4-5
SECTION 5 CLOCK-CALENDAR FEATURE	5-1
5.1 Configuration of the SixPakPlus Clock-Calendar	5-1
5.1.1 Disabling the Clock-Calendar	5-2
5.2 The ASTCLOCK Utility: Setting the PC TIME and DATE	5-2
5.3 The SETCLOCK Utility: Setting the AST TIME and DATE	5-2
5.4 Preparing Your Working DOS Diskettes	5-4
5.5 The Clock-Calendar Battery	5-5
5.6 Technical Information	5-6
5.6.1 Clock-Calendar Interrupt Generation	5-6
SECTION 6 GAME ADAPTER PORT	6-1
6.1 Configuration of the SixPakPlus Game Adapter Port	6-1
6.1.1 Installing the Cable	6-2
6.1.2 Disabling the Game Adapter Port	6-2
6.2 Software Compatibility	6-3
6.3 Technical Information	6-3
6.4 Diagnostic Testing of the Game Port	6-3
SECTION 7 INSTALLING YOUR SIXPAKPLUS CARD	7-1
7.1 Testing the New Installation	7-2
SECTION 8 USER UPGRADE INFORMATION	8-1

TABLE OF CONTENTS

(Continued)

APPENDICES

Appendix A: Recommended Serial Port Cabling	A-1
Appendix B: Switching Between LPT1 and LPT2	B-1
Appendix C: Wiring RS-232 Serial Interfaces	C-1
Appendix D: Patches for Specific I/O Problems	D-1

FIGURES

Figure 1-1. SixPakPlus Board Layout	1-5
Figure 2-1. Starting Address Settings	2-2
Figure 2-2. SixPakPlus Memory Size Settings	2-3
Figure 2-3. Parity Check Enable Setting	2-4
Figure 2-4. PC-1 System Board Switch Settings	2-5
Figure 2-5. PC-2 System Board Switch Settings	2-6
Figure 2-6. PC-XT System Board Switch Settings	2-7
Figure 3-1. Serial Port Factory Configuration	3-2
Figure 3-2. Creating a "Forced True" State	3-3
Figure 4-1. Parallel Port Factory Configuration	4-1
Figure 5-1. Clock-Calendar Factory Configuration	5-2
Figure 5-2. Clock Interrupt Block Locations	5-8
Figure 6-1. Game Adapter Port Factory Configuration	6-1
Figure C-1. Ideal Case: DTE to DCE Interface	C-3
Figure C-2. Typical (Non-Ideal) Case: DTE to DTE Interface	C-5
Figure C-3. DTE to NEC 7700 Printer Interface	C-6
Figure C-4. Serial Interface Form	C-7

TABLES

Table 5-1. Clock-Calendar Chip I/O Addressing	5-7
---	-----

(This page intentionally left blank)

SECTION 1

GENERAL OVERVIEW

The AST SixPakPlus™ is a flexible and powerful multifunction enhancement product for the IBM Personal Computer (PC) family. The SixPakPlus provides memory expansion upgradeable to the maximum addressable user memory in the new PC and PC-XT systems. It is also a powerful data I/O accessory; standard features include the real-time Clock-Calendar with battery backup, an RS-232 asynchronous Serial communications port, and a Parallel printer port. An optional Game adapter port is also provided.

Your SixPakPlus is supplied with two valuable utility programs: SuperDrive™, a disk emulation program allowing you to use part of your memory as a superfast “electronic diskdrive,” and SuperSpool™, an intelligent print spooler allowing you to output files to a printer without tying up your PC. These utilities are discussed in the *SuperPak User's Manual*.

1.1 Compatibility

The SixPakPlus is completely compatible with all existing IBM PC types. It is also compatible with the Compaq and other IBM look-alikes. The three existing IBM PC models are defined as follows:

1. The **PC-1** is the original IBM Personal Computer. The system board contains 64K of memory. The system maximum memory capacity is 640K. System board switches, however, recognize a maximum of 544K.
2. The **PC-2** is the newer, updated version of the PC-1. The system board **must** be fully populated with 256K of memory before utilizing any expansion card memory. If your PC-2 is **not** fully populated, then the AST Memory Upgrade Kit can be used for this purpose. Switch settings are given in Section 2. The maximum memory capacity of this system is 640K.

3. The **PC-XT** comes standard with 128K of memory. The system board is expandable to 256K. Unlike the PC-2, the system board does NOT have to be fully populated before using expansion card memory; you may, however, use AST memory upgrade kits on your system board if desired. The XT computer automatically recognizes memory up to a maximum of 640K.

The XT comes with a standard serial port configured as COM1. Your SixPakPlus card comes with a standard serial port that should be reconfigured as COM2 to avoid addressing conflicts with COM1. Section 3 of this manual contains the necessary reconfiguration instructions.

1.2 Standard features

The following are standard features of the SixPakPlus:

- 64K RAM memory.
- An RS-232C Serial interface to be used with a modem, serial printer, remote display terminal, or other serial device, or as an asynchronous communications port to another computer or peripheral operating under separate asynchronous communications software control. (Note: a current loop teletype interface is not supported.)
- A Parallel printer port to be used for connecting a parallel printer to the PC.
- A real-time Clock-Calendar with battery backup so that you don't have to reenter the time and date every time you start your system. The battery power is only used when your system is turned off.

- The SuperPak™ utility diskette containing SuperDrive™, SuperSpool™, clock software, and the RAMCLEAR memory initialization utility program.

NOTE

For information on the SuperPak utilities, see your *SuperPak User's Manual*.

1.3 Available options

The following options are provided:

- Memory Expansion available in 64K increments up to 384KB. The 384K on the SixPakPlus added to 256K on the PC-2 or PC-XT system board provides 640K, the maximum addressable user memory for these systems. Each 64K upgrade consists of one AST P/N MP-009 Memory Upgrade kit.
- A Game adapter port which can be used with an IBM-compatible joystick (AST P/N SPK-000G).

These options may be purchased onboard or installed by the user at a later date. Upgrade kits are available from your dealer.

1.4 “Do I Really Need to Read This Manual?”

AST recommends that you thumb through this manual at your leisure, and read up on the SuperPak utilities in the *SuperPak User's Manual* as well.

If you have problems, you should go back and read the appropriate section for some helpful hints, and to clarify the conditions necessary for your SixPakPlus card to function properly.

NOTE

Be sure to fill out your warranty card and mail it in.

1.5 System Requirements: Non-PC-DOS Operation

All references to operating system commands in this manual assume operation under PC-DOS. The SixPakPlus hardware is completely IBM-compatible and will function properly under other IBM-approved operating system software. Of course, configuring the I/O ports under another operating system requires the use of commands specific to that operating system. See your operating system manual for the appropriate command syntax.

1.6 SixPakPlus Board Layout

Figure 1-1 shows the SixPakPlus board layout with major features labeled.

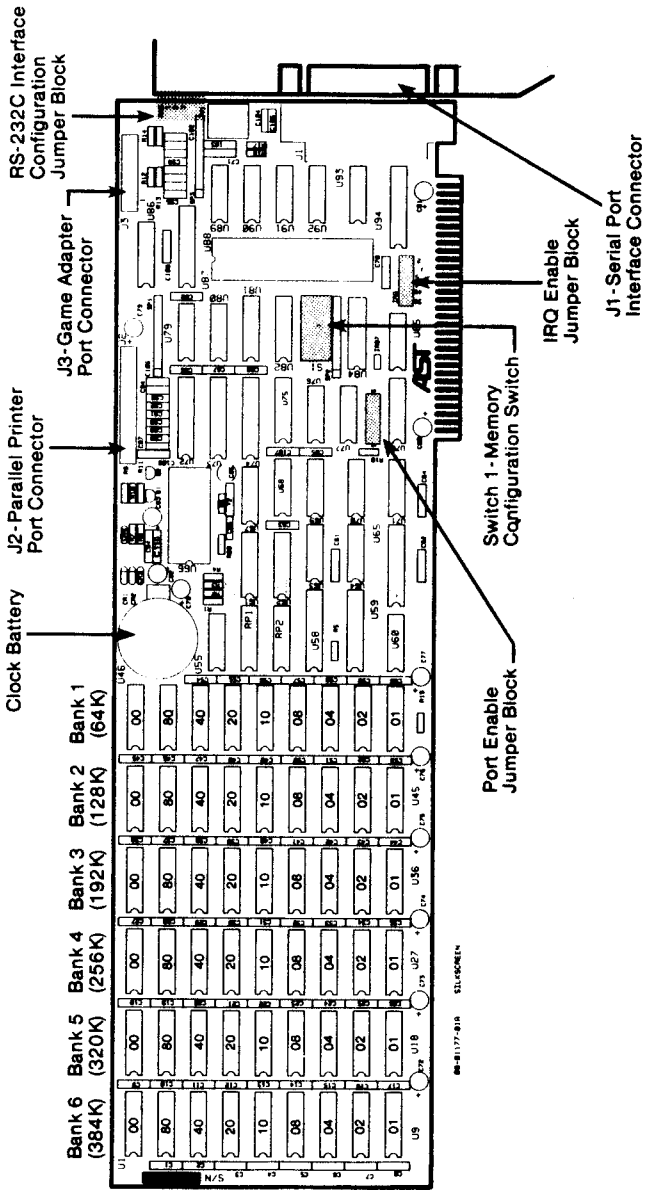

Figure 1-1. SixPakPlus Board Layout

(This page intentionally left blank)

SECTION 2

SIXPAKPLUS MEMORY CONFIGURATION

In order to use the memory on your SixPakPlus card, you must properly configure both the SixPakPlus board and the PC system board. Subsection 2.1 covers configuration of the switches on the SixPakPlus. Subsection 2.2 describes configuration of the system board switches. The system board configuration process varies, depending on whether you have a PC-1, PC-2, or PC-XT. Subsection 2.3 covers the installation of other memory expansion boards in your PC along with the SixPakPlus.

CAUTION

Always be sure that the power switch on the PC is turned OFF before installing or removing ANY board in your System Unit!

2.1 SixPakPlus Memory Switch Settings

Switch #1, the "Memory Configuration Switch" (refer to Figure 1-1) on the SixPakPlus controls three different functions related to the memory on the card. The three functions which must be configured are:

1. The starting address of the SixPakPlus
2. The amount of memory installed on the SixPakPlus
3. Parity checking (enabled or disabled).

These functions are controlled by setting various positions of the Memory Configuration Switch. The following three topics describe these switch settings for the SixPakPlus.

2.1.1 SixPakPlus Starting Memory Address

The SixPakPlus card must be properly configured to indicate the amount of memory installed below it, or in other words, what its starting address should be. Positions 1 through 3 of Switch #1, the Memory Configuration Switch, are used to set the SixPakPlus' starting address. Figure 2-1 shows the SixPakPlus starting address settings.

Depending on the type of PC that you have, you will use one of the following three settings for the SixPakPlus starting address.

PC-1: When installing the SixPakPlus in a PC-1, configure the SixPakPlus' starting address to the 64K setting in Figure 2-1.

PC-2: When installing the SixPakPlus in a PC-2, a Compaq, or other compatible system with a 256K system board, configure the SixPakPlus' starting address to the 256K setting in Figure 2-1.

SixPakPlus Starting Memory Address

Starting Address	S1	S2	S3	Maximum RAM On SixPak
64K (:10000)	OFF	OFF	OFF	384K
128K (:20000)	OFF	OFF	ON	384K
192K (:30000)	OFF	ON	OFF	384K
256K (:40000)	OFF	ON	ON	384K
320K (:50000)	ON	OFF	OFF	320K
384K (:60000)	ON	OFF	ON	256K
448K (:70000)	ON	ON	OFF	192K
512K (:80000)	ON	ON	ON	128K

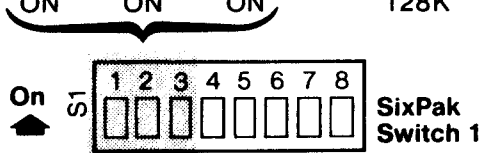

Figure 2-1. Starting Address Settings

PC-XT: When installing the SixPakPlus in a PC-XT, configure the SixPakPlus' starting address to the setting in Figure 2-1 which corresponds to the amount of memory installed on the PC-XT system board.

Notice that the SixPakPlus automatically begins limiting the amount of usable memory on the card when its starting address is configured at 320K or higher. The SixPakPlus can be addressed only within the first 640K of the PC, and its starting address can be no higher than 512K. This is to prevent conflicts between memory on the SixPakPlus and areas reserved for the monochrome and color display cards.

2.1.2 Amount of Memory Installed on the SixPakPlus

The SixPakPlus must be told the amount of memory installed on it by configuring positions 4 through 6 of the SixPakPlus Switch #1. Refer to Figure 2-2 for these switch settings.

Number of Banks Installed on the SixPakPlus

Banks Installed	S4	S5	S6	Total SixPak RAM
NONE	OFF	OFF	OFF	0K
1	OFF	OFF	ON	64K
2 (1-2)	OFF	ON	OFF	128K
3 (1-3)	OFF	ON	ON	192K
4 (1-4)	ON	OFF	OFF	256K
5 (1-5)	ON	OFF	ON	320K
6 (1-6)	ON	ON	OFF	384K

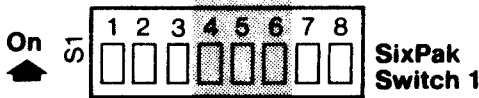

Figure 2-2. SixPakPlus Memory Size Settings

Note that when the starting address (see Topic 2.1.1) is 320K or higher, the SixPakPlus automatically begins limiting the amount of usable memory on the card. This is to prevent conflicts with areas of memory reserved for the monochrome or color display cards. This occurs even if positions 4 through 6 of Switch #1 are configured for more memory than the maximum indicated in Figure 2-1.

2.1.3 Parity Check Enable

Position 8 of Switch #1 on your SixPakPlus can be set to enable full parity error checking. In order to ensure the highest possible data integrity, it is recommended that the parity check function of the board always be enabled by leaving this switch ON. If, however, you have a particular application in which you wish to disable parity checking, then you can do so by turning position 8 OFF. See Figure 2-3 for the location of this position.

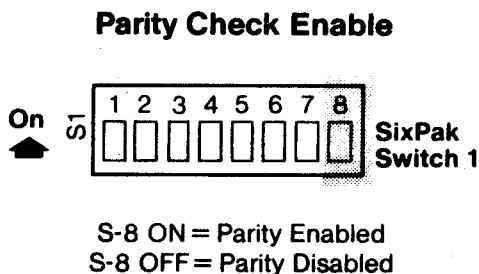

Figure 2-3. Parity Check Enable Setting

2.2 PC System Board Switch Configuration

The PC-1 and PC-2 must be told the exact amount of total memory installed in the system. This is done by configuring switches on the system board. The switch settings for these two PC models are described below in Topics 2.2.1 and 2.2.2. The PC-XT is slightly different; its switch settings are described in Topic 2.2.3. You may also want to refer to the appropriate IBM *Guide to Operations* manual for your particular PC model.

2.2.1 PC-1 System Board Switch Settings

Figure 2-4 should be used if you are installing your SixPakPlus in a PC-1. To determine the correct system board switch setting, add together the amount of memory on the system board (64K) and the amount of memory on the SixPakPlus. Set the PC-1 system board Switch #2 to the corresponding total from Figure 2-4.

Notice that the system board switches for the PC-1 have a maximum setting of 544K, even though you may install up to 640K in the computer. Many "canned" application programs available for the PC get "confused" when the switches are set for 544K; we recommend that if you have more than 512K installed in your PC-1, that you use a setting of 512K. The excess beyond that setting is still usable by SuperDrive and SuperSpool, as well as certain other programs. If your PC-1 is equipped with the IBM Expansion Unit and has the new ROM BIOS installed, then you can address a full 640K, and you should use the switch settings for the PC-2 (see Figure 2-5).

Total Memory Installed in PC-1

Total Memory	S1	S2	S3	S4
64K	ON	ON	ON	ON
128K	ON	OFF	ON	ON
192K	ON	ON	OFF	ON
256K	ON	OFF	OFF	ON
320K	ON	ON	ON	OFF
384K	ON	OFF	ON	OFF
448K	ON	ON	OFF	OFF
512K	ON	OFF	OFF	OFF
544K	OFF	OFF	OFF	OFF

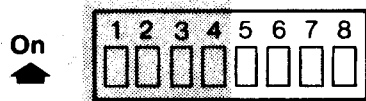

PC-1 System Board
Switch 2

Figure 2-4. PC-1 System Board Switch Settings

2.2.2 PC-2 System Board Switch Settings

Figure 2-5 should be used if you are installing your SixPakPlus in a PC-2. To determine the correct system board switch setting, add together the amount of memory on the system board and the amount of memory on the SixPakPlus. Use the appropriate total from Figure 2-5. Please note that when you include memory on the SixPakPlus in this total, that your system board must be fully populated with 256K. If your PC-2 system board does not contain 256K, do not include the SixPakPlus memory in the total system memory. Please refer to Subsection 1.1 of this manual for further clarification on this.

Total Memory Installed in PC-2

Total Memory	S1	S2	S3	S4	S5
64K	ON	ON	ON	ON	ON
128K	ON	OFF	ON	ON	ON
192K	ON	ON	OFF	ON	ON
256K	ON	OFF	OFF	ON	ON
320K	ON	ON	ON	OFF	ON
384K	ON	OFF	ON	OFF	ON
448K	ON	ON	OFF	OFF	ON
512K	ON	OFF	OFF	OFF	ON
576K	ON	ON	ON	ON	OFF
640K	ON	OFF	ON	ON	OFF

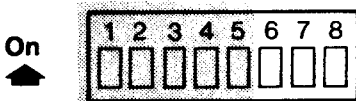

PC-2 System Board
Switch 2

Figure 2-5. PC-2 System Board Switch Settings

2.2.3 PC-XT System Board Switch Settings

The PC-XT differs from the PC-1 and PC-2 in how its system board switches are configured. In the PC-XT, the system board switch tells the computer only the amount of memory installed on the system board, and does not include any memory which may be installed on an expansion board such as the SixPakPlus. The PC-XT will automatically recognize the expansion board memory, and will include this memory in the total system memory, up to a maximum of 640K. Furthermore, it is not required that you fully populate the PC-XT system board before you can use the memory on an expansion board. Using Figure 2-6, configure the system board switches for the amount of memory on the XT system board (128K in a stock PC-XT).

Memory On PC-XT System Board

System Board Memory	S3	S4
128K	OFF	ON
192K	ON	OFF
256K	OFF	OFF

On 

1	2	3	4	5	6	7	8
<input type="checkbox"/>	<input type="checkbox"/>	<input checked="" type="checkbox"/>	<input type="checkbox"/>	<input type="checkbox"/>	<input type="checkbox"/>	<input type="checkbox"/>	<input type="checkbox"/>

PC-XT System Board Switch

Figure 2-6. PC-XT System Board Switch Settings

2.3 Installing Multiple Memory Cards

The advanced design characteristics of your SixPakPlus make it compatible with most other expansion cards available for the IBM PC. However, when more than one card is installed, you must pay particular attention to how each card is configured in order to prevent conflicts between them.

When installing multiple memory cards, you must first determine where each card is to reside in the PC's memory area. Your SixPakPlus can usually be installed either "above" or "below" the address space occupied by another card.

2.3.1 Installing a Card "Below" the SixPakPlus

If another memory card is to be addressed "below" the SixPakPlus, then you should follow the procedure listed below.

STEP 1

Following the instructions supplied with the other card, configure it to reside immediately "above" the memory on the PC system board.

STEP 2

If there are any unused rows of memory sockets on the other card, the unused rows must be disabled so that they will not conflict with the SixPakPlus. Refer again to the other card's manual for information on how to disable these sockets. If the unused memory sockets cannot be disabled, you should address the other card "above" the SixPakPlus (see Topic 2.3.2). If the other card has switch settings for the amount of memory on it, then it will probably automatically disable any unused memory sockets.

STEP 3

Add the amount of memory on the other card to the amount of memory on the PC's system board, and set the starting address of the SixPakPlus at this value, as per Figure 2-1 of this manual.

STEP 4

Set the PC system board switches for the total amount of memory on the system board, the SixPakPlus, and the other card.

2.3.2 Installing a Card "Above" the SixPakPlus

If another memory card is to be addressed "above" the SixPakPlus, then you should follow these steps:

STEP 1

Referring to Figures 2-1 and 2-2, configure your SixPakPlus so that (1) its starting address corresponds to the amount of memory on the PC system board, and (2) it is set for the correct amount of memory on the SixPakPlus itself.

STEP 2

Following the instructions supplied with it, configure the other memory card to see "below" it the total of the PC system board memory added to that on the SixPakPlus. If necessary, also configure this card for the amount of memory installed on it.

STEP 3

Set the PC system board switches for the total amount of memory including the system board, the SixPakPlus, and the other card.

2.4 Installing Additional Memory on the SixPakPlus

A SixPakPlus configured with less than its 384K maximum memory can be upgraded at any time by installing additional 64K RAM sets, such as AST Memory Upgrade Kit P/N MP-009. The correct type of chip to be used is 64K dynamic memory, 200 nanosecond access time, pin 1 not used, +5 Volt only. The following memory chips are compatible with the SixPakPlus or the PC and PC-XT system board:

Fujitsu MB8264-20

Hitachi HM4864P-3

Micron Technology MT4264-3
or MT4264-20

Mitsubishi M5K4164NS-20

Motorola MCM6665AL-20

or MCM6665AP-20

NEC D4164D-2 or D4164C-2

OKI M3764-20RS

Texas Instruments TMS4164-20NLJ

There are five steps to follow when adding memory to the SixPakPlus.

STEP 1

Shut off the power to the PC and remove the SixPakPlus from the system unit.

STEP 2

Install each additional set of nine 64K memory chips in the next consecutive empty bank on the card. For example, referring to Figure 1-1, if your SixPakPlus has 64K on it now, it contains memory in Bank 1. If you are adding 128K to the SixPakPlus, you will install two sets of 64K chips, one each in Banks 2 and 3. Inspect the installation of the new chips very carefully, paying particular attention to possible bent legs.

STEP 3

Referring to Figure 2-2, configure Switch #1 on the SixPakPlus to reflect the new total amount of memory on the card.

STEP 4

Referring to the appropriate figure for your PC-1 or PC-2, set Switch #2 on the system board to the new total amount of memory installed in the PC. This step is unnecessary with the PC-XT.

STEP 5

Reinstall the SixPakPlus in the system unit and power up the PC. Because there is now additional memory in the PC, the powerup diagnostics will take longer to run. If all goes well, the system should operate normally and show the correct new total amount of memory when you run CHKDSK. If you get an error, recheck the installation of the new chips and the switch settings on both the system board and the SixPakPlus. If everything appears to be correctly installed and configured, and you still get an error, then proceed to Subsection 2.5 for help in troubleshooting the problem.

2.5 Troubleshooting Memory Problems

The most common indication of a memory problem in the PC is a **PARITY CHECK 2** message on powerup. This message is preceded by a four-digit number, followed by the error code for a memory problem (**201**). For example, you might get an error of **4020 201** on powerup, followed by the **PARITY CHECK 2** message. The four-digit number can sometimes be used to isolate the problem to a specific memory chip.

The first digit of the four-digit value tells us in which 64K bank the error is occurring. Using the example above, **4020** tells us that the error is occurring in Bank 4 of the PC; since the banks are numbered beginning at zero, **4020** is actually the fifth bank in the system. If you have a PC-1, this error code would be pointing to Bank 4 of the SixPakPlus; Bank 0 is on the system board, followed by Banks 1 thru 6 on the SixPakPlus.

If you have a PC-2, don't confuse the bank numbering scheme used in Figure 1-1 with the bank indicated by the PC's error code. In the PC-2, error codes falling on Banks 0 thru 3 are on the system board, followed by Banks 4 thru 9 on the SixPakPlus. Therefore, the error code in a PC-2 must be translated into the "real" bank number on the SixPakPlus by subtracting 3 from the first digit: **4020** falls on Bank 1 of the SixPakPlus when installed in a PC-2.

The second digit, a zero in the **4020** example, should be ignored. The third and fourth digits, **20**, tell us which bit is failing in the 8-bit data byte. Referring to Figure 1-1, notice that in Bank 1, each of the nine memory chip sockets contains a two-digit value; the fourth chip from the top corresponds to a value of **20**, so that would be the failing location for an error code of **4020** in a PC-2. In a PC-1, the problem would be in the fourth chip from the top in Bank 4 of the SixPakPlus.

Once you have determined the chip that you believe to be causing the problem, you should replace it with a spare chip and see if the error is corrected. If no spare chip is available, you could try exchanging the suspect chip with another one in the same bank which is not failing. If the error then moves to the new socket, you definitely have a bad chip. If the error persists at the original

socket, you may have a problem with the board; contact your dealer for assistance.

If the third and fourth digits of the error code do not match any of the values indicated in Figure 1-1, you may be experiencing errors with more than one memory chip. This could be due to incorrect switch settings, multiple bad memory chips, or even something as simple as a dirty gold edge connector. If you are unable to remedy the problem, contact your dealer for assistance.

If the failing bank number is higher than the amount of memory installed in the PC, recheck your system board switch settings.

SECTION 3

SERIAL PORT

Your SixPakPlus has as a standard feature one serial port for asynchronous communications. This port can be used to connect your PC to a serial printer, modem, or other device which uses an RS-232C interface. The SixPakPlus interface is a DTE type (Data Terminal Equipment) with a male DB25 connector.

3.1 Configuration of the SixPakPlus Serial Port

The IBM PC allows installation in the computer of up to two serial ports, called COM1 and COM2. The serial port on your SixPakPlus has been configured at the factory to respond as COM1. This can be confirmed by examining the position of the shorting plugs on the Port Enable Jumper Block and the IRQ Enable Jumper Block in Figure 3-1. Shorting plugs should be installed on positions "1" and "4S" respectively.

3.1.1 Installing Multiple Serial Ports in a PC

If your PC already has another card with a serial port on it configured to respond as COM1 (such as the PC-XT with its standard serial board), then you must change the port on the SixPakPlus to respond as COM2. Referring again to Figure 3-1, move the shorting plug from "1" to "2" on the Port Enable Jumper Block, and from "4S" to "3S" on the IRQ Enable Jumper Block. The serial port on the SixPakPlus will now respond as COM2.

3.1.2 Configuring the RS-232C Interface Lines

Because AST Research has adhered to RS-232C engineering standards, all inputs to an AST serial port with the exception of Ring Indicator, pin 22, must be connected to a signal, even if the

Port Enable Jumper Block

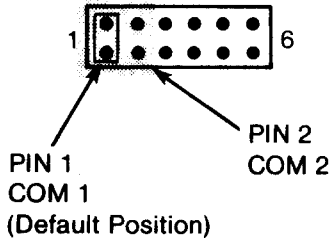

IRQ Enable Jumper Block

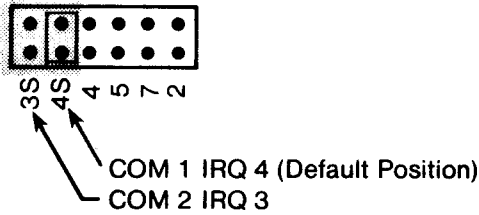

Figure 3-1. Serial Port Factory Configurations

device the port is connected to is not using one or more of the interface lines at connector J1. In its factory (default) configuration, the serial port on the SixPakPlus expects that the connected device will be driving all its inputs. If, however, your serial device does not drive all the SixPakPlus inputs, you can use the RS-232C Interface Configuration Jumper Block on the card to cause the inputs to be in a "Forced True" state. The following three inputs to the serial port can be forced into a true state at all times by reconfiguring the interface:

- BLOCK PIN 1: CTS input (J1 pin 5)
- BLOCK PIN 2: DSR input (J1 pin 6)
- BLOCK PIN 3: DCD input (J1 pin 8)

Refer to Figure 3-2. To force one or more of the above signals to always be in the true state, you would move the corresponding shorting plug on the RS-232C Interface Configuration Jumper Block from the left pair of pins (“Normal”) to the right pair of pins (“Forced True”). For example, to force DSR to always be in the true state, you would move the shorting plug on block position 2 (labeled in Figure 3-2 as “2 DSR”) from the left pair of pins to the right pair of pins. If you force a signal to the true state in this manner, then the connection of the corresponding input signal on the serial interface connector J1 will have no effect on the function of the port whatsoever.

The device connected to the port determines whether or not a need exists to change the shorting plugs on the RS-232C Interface Configuration Block from the factory configuration. You may prefer to leave the shorting plugs in their “Normal” configuration and instead build a special cable for the serial device. This is especially true if you will be using two or more different serial devices on the port at different times. In Appendix A, many of the wiring diagrams for various printers show two or three pins jumpered together at the SixPakPlus end of the cable. If you follow these diagrams, you should leave the shorting plugs on the card in the “Normal” position.

Appendix C also has general information on building cables for devices not listed. You may want to refer as well to the manual supplied with your serial device for help in designing these cables.

RS-232C Interface Configuration Block

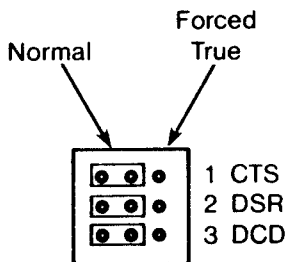

Figure 3-2. Creating a “Forced True” State

3.1.3 Disabling the Serial Port

The serial port on the SixPakPlus can be completely disabled by removing both of the shorting plugs referred to in Figure 3-1. This means that the shorting plugs on either "1" or "2" would be removed from the Port Enable Jumper Block, as would "3S" or "4S" on the IRQ Enable Jumper Block. Disabling the serial port would be necessary if your PC already has two serial ports installed in order to prevent conflicts between multiple ports. Be sure to save these shorting plugs for possible future use.

3.2 Programming the Serial Port

The serial port on the SixPakPlus is completely under software control, and must be initialized for correct baud rate, parity, number of databits, and number of stopbits before it can be used. Typically, this is done with the DOS MODE command (refer to your DOS manual for a detailed explanation of this command). This initialization must be performed each time you turn on the computer in order for the serial port to operate correctly. A typical MODE command might look like this:

```
MODE COM1:1200,N,8,1,P<enter>
```

The above command would initialize serial port COM1 for 1200 Baud, no parity, 8 databits, and 1 stopbit. The "P" is optional and tells DOS that you will be using the port with a serial printer.

Many application programs (such as word processors) will handle this initialization of the port automatically, thus making it unnecessary to use the MODE command. Refer to your software manual; if no mention is made of the MODE command, then it is probably safe to assume that you can omit that step. If you are unsure, it will not harm anything to go ahead and use the MODE command anyway.

If you are using the serial port to operate a serial printer, you may also need to redirect printer output from LPT1 to COM1 or COM2 as appropriate. This redirection is necessary because DOS always assumes that printer output goes to parallel port LPT1 unless told

otherwise. The redirection of output is accomplished with a MODE command such as one of the following:

MODE LPT1:=COM1: <enter> For printer serial output to COM1

MODE LPT1:=COM2: <enter> For printer serial output to COM2

If one of the above commands is used, then it should follow the first MODE command in which you set up the baud rate, parity, etc. Again, it is possible that your application program is handling this redirection automatically. If so, you can eliminate this step as well.

3.3 Serial I/O Port Assignments and Pinouts

The serial port on the SixPakPlus uses the following system I/O ports and IRQ interrupt request lines:

Port Configuration	I/O Ports	IRQ Line
COM1	3F8-3FF Hex	IRQ4
COM2	2F8-2FF Hex	IRQ3

The pinouts for the serial port connector J1 on the SixPakPlus are as follows:

RS-232C

Name	J1 Pin #	Signal Name	Direction
AA	1	Chassis Ground	----
BA	2	TX (TRANSMIT DATA)	OUTPUT
BB	3	RX (RECEIVE DATA)	INPUT
CA	4	RTS (REQ. TO SEND)	OUTPUT
CB	5	CTS (CLEAR TO SEND)	INPUT
CC	6	DSR (DATASET READY)	INPUT
AB	7	SG (SIGNAL GROUND)	----
CF	8	DCD (CARRIER DETECT)	INPUT
CD	20	DTR (DATA TERM RDY)	OUTPUT
CE	22	RI (RING INDICATOR)	INPUT*

*Ring Indicator connection is not required

3.4 Diagnostic Testing of the Serial Port

Whenever there is any question as to the functional operation of the serial port on the SixPakPlus, it is recommended that you run the IBM diagnostics, preferably the Advanced Diagnostics supplied with the IBM *Hardware Maintenance Manual*.

For proper operation of the diagnostics, any device which you may have connected to the SixPakPlus serial port, such as a modem or serial printer, must be disconnected. Also, make sure that the CTS, DSR, and DCD jumpers (Figure 3-2) are in the normal setting. Using a "wrap plug" on the J1 connector makes it possible to perform a very thorough test of the serial port with the Advanced Diagnostics. To build this wrap plug, you will need a female DB25 connector, such as a Winchester Electronics P/N 49-1125S. Jumper together the following pins on the connector:

- Pin 2 to Pin 3 (TX to RX)
- Pin 4 to Pin 5 & 22 (RTS to CTS & RI)
- Pin 20 to Pins 6 & 8 (DTR to DSR & DCD)

Answer the Advanced Diagnostic loopback plug question with "Y" when this plug is installed on the J1 connector.

Certain versions of the IBM diagnostics may fail on the first pass. You should therefore ignore the results of the first pass if an error occurs.

PARALLEL PRINTER PORT

The SixPakPlus has as a standard feature a parallel port for interfacing the PC to a parallel printer such as the IBM/Epson MX-80. This port is completely compatible with the IBM PC and uses the same female DB25 connector as an IBM port.

4.1 Configuration of the SixPakPlus Parallel Port

The IBM PC allows installation in the computer of up to three parallel ports, called LPT1, LPT2, and LPT3. The parallel port on the SixPakPlus has been configured at the factory to respond as LPT1 (LPT2 when the monochrome display card is present; see Topic 4.1.2). This can be confirmed by examining the position of the shorting plug on the Port Enable Jumper Block in Figure 4-1. A shorting plug should be installed on position "3" of the block.

Parallel Port Configuration

Port Enable Jumper Block

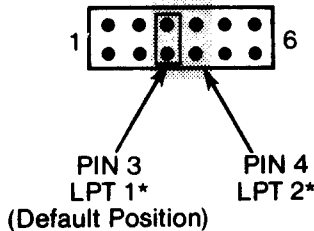

* LPT 2 and LPT 3 respectively when the IBM Monochrome Display Card is installed

Figure 4-1. Parallel Port Factory Configuration

4.1.1 Installing Multiple Parallel Ports in a PC

If your PC already has another card with a parallel port on it configured to respond as LPT1 (excluding the IBM Monochrome Display / Printer Adapter card—see next topic), then you must change either the other card or the SixPakPlus to respond as LPT2. This is necessary to avoid conflicts between the two ports. If you want to change the SixPakPlus, refer again to Figure 4-1 and move the shorting plug from position “3” to position “4.” The parallel port on the SixPakPlus will now respond as LPT2.

4.1.2 IBM Monochrome Display / Printer Adapter Card

If you have the IBM Monochrome Display / Printer Adapter Card installed in your PC, then the parallel port on that card always responds as LPT1 and cannot be changed. The parallel port on the SixPakPlus will automatically respond as LPT2 in its factory default configuration. You do not need to reconfigure the card as outlined in Topic 4.1.1. If you do make that change, the port on the SixPakPlus will respond as LPT3.

4.1.3 Disabling the Parallel Port

The parallel port on the SixPakPlus can be completely disabled by removing the shorting plug shown in Figure 4-1. Disabling the parallel port on the SixPakPlus might be necessary when you have multiple parallel adapters installed in your PC in order to prevent conflicts between them. Be sure to save the shorting plug for possible future use.

4.2 Installing the Parallel Interface Cable

The SixPakPlus is supplied with a ribbon cable for the parallel port to bring the parallel interface out the rear of the PC. This cable is approximately 18” long and has a rectangular connector at one end and a female DB25 connector at the other end.

Refer to Figure 1-1. The rectangular connector on the 18" cable plugs into J2 on the SixPakPlus, while the cable from the printer plugs into the DB25 connector at the opposite end. With the SixPakPlus installed in the PC, route the rectangular connector on the 18" parallel cable through the opening in the SixPakPlus mounting bracket at the rear of the PC, from the outside to the inside of the chassis.

Note that one edge of the 18" flat ribbon cable has a red or blue line on it; this line indicates which end of the rectangular connector is to be installed to Pin 1 of J2. The rectangular connector plugs onto J2 with the red or blue line at the left side of J2 (toward the front of the PC), with the cable exiting toward the back of the SixPakPlus. The DB25 connector at the opposite end of the cable can be mounted on the optional AST Research ConnectAll bracket on the rear panel of the PC. It does not mount in the opening on the SixPakPlus bracket.

4.3 Programming the Parallel Port

The IBM PC always sends printer output to parallel port LPT1 unless specifically told otherwise. Unfortunately, PC-DOS 1.0 and 1.1 will not allow you to redirect output to LPT2 or LPT3. Appendix B of this manual gives information on how to cause the PC to send printer output to LPT2.

Although it is not required, you may want to use the DOS MODE command to set the line width and the number of lines per page. Refer to your IBM DOS manual for more information.

4.4 Parallel Port I/O Port Assignments and Pinouts

The parallel port on the SixPakPlus uses the following system I/O ports:

PORT CONFIGURATION	I/O PORTS
LPT1*	378-37A Hex
LPT2*	278-27A Hex

*LPT2 and LPT3 respectively when the IBM Monochrome Display card is used.

The listing below gives the pinouts for the parallel port on the SixPakPlus and can be used to help in building a cable for your particular parallel printer.

Parallel Port Signal Line Configuration

LINE NAME	J4 Pin	AST ADAPTER CABLE	
		OUTPUT DB25S	IBM MATRIX PRINTER
-STROBE	1	1	1
D0	3	2	2
D1	5	3	3
D2	7	4	4
D3	9	5	5
D4	11	6	6
D5	13	7	7
D6	15	8	8
D7	17	9	9
-ACK	19	10	10
BUSY	21	11	11
PE	23	12	12
SLCT	25	13	13
-AUTOFD	2	14	14
-ERROR	4	15	32
-INIT	6	16	31
-SLCT IN	8	17	36
GROUND	(10,12,14,16, 18,20,22,24)	(18-25)	(16,19-30,33)

(A dash in front of the line name denotes lines which are functionally active when low.)

4.5 Diagnostic Testing of the Parallel Port

Unlike some other multifunction cards, the parallel port on your SixPakPlus is completely compatible with the IBM Diagnostics. However, in order for the port to be recognized by the diagnostics, it must be configured as LPT1.

If you run the Matrix Printer test, your printer must be 100% compatible with an Epson MX-80 or errors will be generated. An Okidata printer, for example, may fail this test.

(This page intentionally left blank)

SECTION 5

THE CLOCK-CALENDAR

The Clock-Calendar comes standard with your SixPakPlus and has the following features:

1. 24-hour clock, maintained in an advanced microprocessor chip on the SixPakPlus board
2. Four-year calendar (no leap year)
3. Battery backup power supply (battery life, approximately one year)
4. User-replaceable Lithium battery
5. Full PC-DOS compatibility.

Optional CP/M-86 and CCP/M-86 clock utility software is available from your dealer.

The AST Research Clock-Calendar can answer the TIME and DATE prompts which the DOS operating system issues each time you boot the system. The PC will not be aware of the existence of any expansion card clock; this is why the clock utility programs supplied on your SuperPak diskette are needed. These programs, `ASTCLOCK.COM` and `SETCLOCK.COM` have the unique functions described in this section.

5.1 Configuration of the SixPakPlus Clock-Calendar

The factory (default) configuration of the Clock-Calendar requires that the shorting plug on the Port Enable Jumper Block be installed on position "6" as shown in Figure 5-1.

Clock-Calendar Configuration

Port Enable Jumper Block

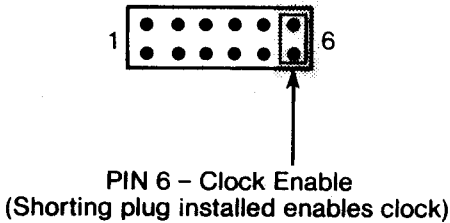

Figure 5-1. Clock-Calendar Factory Configuration

5.1.1 Disabling the Clock-Calendar

The Clock-Calendar can be completely disabled by removing the shorting plug shown in Figure 5-1. This may be necessary in cases of conflict between the ports used by the SixPakPlus clock (reference Subsection 5.6) and other devices installed in your PC.

5.2 The ASTCLOCK Utility: Setting the PC TIME and DATE

ASTCLOCK is a utility program which reads and displays the current time and date from the SixPakPlus at each power-up or reboot of the system. ASTCLOCK eliminates the need for manually entering the correct time and date through the keyboard whenever the PC is turned on or rebooted. See Subsection 5.4.

5.3 The SETCLOCK Utility: Setting the SixPakPlus TIME and DATE

You need to execute the SETCLOCK utility whenever you want to correct the time or date of the SixPakPlus board's internal microprocessor clock. The DOS TIME and DATE commands only

update the system's time and date parameters; they will not update the time and date values stored in the SixPakPlus clock chip until you execute the procedure below.

STEP 1

Boot the system with a diskette that leaves the screen at the A > prompt.

STEP 2

From the DOS prompt A > , enter the following instruction:

SETCLOCK <enter >

NOTE

The SETCLOCK.COM program must be on your DOS diskette.

A message will be displayed on your screen indicating that resident date and time processors are loaded. The current date and time will also be displayed.

STEP 3

Enter the DOS command DATE. The current date will be printed on the screen, and you will be given a chance to enter a new date. Press <enter> if no change is necessary or type a new date in the form **mm/dd/yy <enter >** or **mm-dd-yy <enter >**. DOS will figure out the day of the week from the information that you enter.

STEP 4

Enter the DOS command TIME. The current date will be printed on the screen, and you will be given a chance to enter a new time. Press <enter> if no change is necessary or type a new time in the

form **hh:mm:ss**<enter>. For maximum accuracy, type in a time that is 10 to 15 seconds ahead of the actual time but do not press the <enter> key; observe a digital clock or watch, and press <enter> when the seconds reading on the clock catches up to the value that you typed in.

STEP 5

Reboot the system (Ctrl-Alt-Del) to install the new TIME and DATE values.

5.4 Preparing Your Working DOS Diskettes

After installing your SixPakPlus card, you must prepare your working DOS diskettes to automatically initialize the time and date each time that you boot the system. This subsection lists the process used to invoke your Clock-Calendar.

STEP 1

If you have not already done so, copy the two clock programs, **ASTCLOCK.COM** and **SETCLOCK.COM**, to your working DOS diskette. These programs are on the SuperPak diskette supplied with your SixPakPlus. If you are unsure how to COPY a file, consult your DOS manual.

STEP 2

If your working DOS diskette already has an **AUTOEXEC.BAT** file, then you need to alter that file to include the **ASTCLOCK** command. To see the current contents of your **AUTOEXEC** file, insert the working DOS diskette in drive A: and from the **A>** prompt, type the following command line:

TYPE AUTOEXEC.BAT <enter>

The contents of your **AUTOEXEC** file will be listed on your CRT screen. You now need to create a new **AUTOEXEC** file in which

the command **ASTCLOCK** precedes these other command(s). The following sequence will do this for you:

```
COPY CON: AUTOEXEC.BAT <enter>  
ASTCLOCK <enter>
```

```
<Function key F6> <enter>
```

If your working DOS diskette has no **AUTOEXEC** file, then you should use the above sequence to create one. The only command in the file will be **ASTCLOCK**.

STEP 3

If necessary, use the **SETCLOCK** utility to give the **TIME** and **DATE** variables their initial values as detailed in Subsection 5.3.

5.5 The Clock-Calendar Battery

The lithium battery is easily replaceable and should last for about a year. Since the battery is used only when your PC is not operating, the actual life of your battery will be determined by how much the PC is used. The more the PC is in use, the longer the battery will last. The clock chip on your SixPakPlus is powered by the PC system when your PC is on. The battery is used as backup power while your PC is off. To replace the battery, slightly lift the retaining clip with your finger (or a small screwdriver) and use another small screwdriver to pry up the silver battery from its holder, then slide it out sideways. Do not remove the battery socket from the board. Replacement batteries can be purchased from your dealer (AST P/N 108-BR2325).

Take care not to damage or bend the retaining clip by lifting it too far. The clip completes an electrical circuit and must make solid contact with the positive (+) side of the battery. Whenever the battery is removed, it is a good idea to check the clip in the bottom

of the battery holder; be sure that it is sticking up high enough to make good contact with the bottom surface of the battery. When installing a new battery, make sure it is clean and dry.

NOTE

If you replace the battery, be sure to use the SETCLOCK procedure to restore the proper time and date.

5.6 Technical Information

This technical information is for reference only; you do not need to read this section to use the Clock-Calendar feature. The Clock-Calendar is at I/O address hexadecimal 2C0 and uses 32 contiguous locations for programming functions. Table 5-1 contains a breakdown of programming functions and locations.

5.6.1 Clock-Calendar Interrupt Generation

The Clock-Calendar feature of the SixPakPlus does not normally need or support interrupts. By writing your own software, however, it is possible to program the SixPakPlus to generate timed interrupts on any of the IRQ2, IRQ4, IRQ5, or IRQ7 interrupt lines. To implement this feature, you will need to do the following:

1. Obtain data sheets for the National Semiconductor MM58167AN Clock chip, available only from your local National Semiconductor distributor
2. Enable clock interrupts on the SixPakPlus by installing a shorting plug on the appropriate position of the Interrupt Select Jumper Block (Figure 5-2).
3. Write your own software to handle the interrupts, based upon the information contained in the clock chip data sheets and in the *IBM Technical Reference Manual*. These are the **only** sources of help or information on this subject.

Table 5-1. Clock-Calendar Chip I/O Addressing

I/O Address	Function
2C0	counter-1/10000 of seconds
2C1	counter-1/100 and 1/10 seconds
2C2	counter-seconds
2C3	counter-minutes
2C4	counter-hours
2C5	counter-days of the week
2C6	counter-day of the month
2C7	counter-month
2C8	RAM-upper nibble only
2C9	RAM-last month storage
2CA	RAM-year storage (-80)
2CB	RAM-reserved
2CC	RAM-not used
2CD	RAM-not used
2CE	RAM-not used
2CF	RAM-not used
2D0	interrupt status register
2D1	interrupt control register
2D2	counter reset
2D3	RAM reset
2D4	status bit
2D5	GO command
2D6	standby interrupt
2DF	test mode

Counter and RAM reset format

Data	Function
01	1/10000 of seconds
02	1/100 and 1/10 of seconds
04	seconds
08	minutes
10	hours
20	days of the week
40	days of the month
80	months

Figure 5-2 indicates the location of the positions on the block that relate to the clock interrupts.

You should not enable the SixPakPlus clock interrupt feature unless you have (1) written your own software to handle the interrupts and (2) double-checked that the IRQ line that you have selected does not conflict with any other device installed in the PC (for example, COM1 normally uses IRQ4).

Please do not contact AST Research for assistance in implementing clock interrupts—we do not have any further information on the subject other than what is supplied in this manual and in the above referenced technical manuals.

Clock-Calendar Interrupts

IRQ Enable Jumper Block

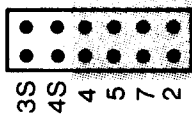

In normal operation, no shorting plugs should be installed.

Figure 5-2. Clock Interrupt Block Locations

SECTION 6

GAME ADAPTER PORT

This section describes the optional Game Adapter port for the SixPakPlus card. One IBM-compatible joystick may be used in conjunction with this port.

6.1 Configuration of the SixPakPlus Game Adapter Port

In order to enable the game hardware, all of the required parts must be installed and a shorting plug should be inserted in the Port Enable Jumper Block.

Place the SixPakPlus card so that the black mounting bracket is towards the right, and find the Port Enable Jumper Block (see Figure 1-1). You should place a jumper so that it bridges the fifth set of pins. You can locate this pin pair by counting over from the first set (designated by a "1") or the last set (designated by a "6"). See Figure 6-1.

Game Adapter Port Configuration

Port Enable Jumper Block

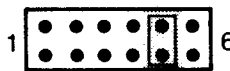

PIN 5 – Game Port Enable
(Shorting plug installed enables game port)

Figure 6-1. Game Adapter Port Factory Configuration

6.1.1 Installing the Cable

The cable cannot be routed until the card is installed.

Place the SixPakPlus card so that the mounting bracket is towards the right. Near the top right corner of the card is the set of pins designated as J3 (see Figure 1-1).

Notice the interface cable supplied with your card. It has a small plastic connector at one end and a DB15S (socket or female type) connector at the other end. The end with the small plastic connector plugs into J3 of your SixPakPlus card. The cable is routed through an expansion slot in the rear panel of the PC or through the rear of the mounting bracket to connect to the IBM joystick cable.

Position the connector over J3. Make sure that pin 1 on the cable is matched up with pin 1 on J3. (Pin 1 on J3 is designated by a "1" near the connector; the V-shaped notch on the cable's connector means that pin 1 is on that corner.) The cable should be extending down over the board. Gently press the connector onto the row of pins. It should slide on easily with even pressure. If your cable exits J3 at the top, you will need to bend the cable at a sharp angle back toward the bottom so it does not interfere with installation of the PC cover.

6.1.2 Disabling the Game Adapter Port

The Game Adapter port on the SixPakPlus card can be completely disabled by removing the jumper discussed in Subsection 6.1.

6.2 Software Compatibility

The game port is totally software-compatible with the IBM game adapter when using the IBM-type joystick.

NOTE

Since there are always variations among joysticks, some software may not function properly, even when an IBM-type joystick is being used. Therefore, AST suggests that you buy only quality software and make sure that a joystick-centering function is provided.

6.3 Technical Information

The Game Adapter is at I/O address hexadecimal 201. This technical information is for reference only; you do not need to know this to use the Game Adapter.

6.4 Diagnostic Testing of the Game Port

The Game Adapter Port can be tested using the IBM diagnostics. Because of a problem in the diagnostic program, however, the port may not always show up on the listing of installed devices. You may prefer to use the program below to test out the port. This program requires the use of BASICA (not BASIC).

```
10 DEFINT A-Z:KEY OFF:CLS:STRIG ON:SCREEN 2
20 PRINT " X1", " Y1", "S1", " S3"
30 X1=STICK(0):Y1=STICK(1)
40 A=STRIG(1):C=STRIG(5)
50 LOCATE 3:PRINT X1,Y1,A;C
60 GOTO 30
```

When running the above program, moving the joystick in the X-plane (left-right) causes a change in the "X1" readout, while moving the joystick in the Y-plane (up-down) causes a change in the "Y1" readout. Pressing the switch (either one or two, depending on your joystick) causes a change in the "S1" or "S3" readouts from 0 to -1. Note that, depending on the quality of your joystick, you may not be able to get a zero reading in the X and Y planes when running the program.

SECTION 7

INSTALLING YOUR SIXPAKPLUS CARD

The SixPakPlus card can be inserted in any one of the five expansion slot receptacles on the PC system board.

CAUTION

Be sure that the power is off and that the power cord is removed from the PC before installing or removing any equipment.

STEP 1

Select an open expansion slot, and locate the metal bracket that covers the cut-out in the back panel of the PC chassis for the slot that you have selected. Remove and save the bracket-retaining screw using a small flathead screwdriver. Remove the bracket.

STEP 2

Install the plastic card guide supplied with the SixPakPlus on the inside of the front panel of the PC.

STEP 3

Line up your SixPakPlus card and position its front bottom corner in the plastic card guide channel. Keeping the top of the SixPakPlus card level, lower the card until its edge connector is resting on the expansion slot receptacle. Using an evenly distributed pressure, press the SixPakPlus straight down until it seats in the expansion slot. Install the bracket-retaining screw that was removed in STEP 1 to secure the SixPakPlus bracket to the rear of the PC chassis.

STEP 4

If your PC has a cut-out above the keyboard connector on the rear panel, route the adapter cable(s) under all the cards and out to the cut-out. The cut-out's plastic cover can be removed easily by pressing it towards the rear. You can also install the "D" connectors in the supplied extra brackets in unused PC slots.

STEP 5

You can replace the system unit's cover prior to check out or you can wait until later. To replace the cover, carefully slide the cover from the front until it stops securely against the rear panel. Reinstall the two screws you removed earlier from the lower corners.

STEP 6

Replace the power cord to the system unit and be sure that the keyboard and the monitor connectors are plugged in.

7.1 Testing the New Installation

The following procedure tests your new installation.

STEP 1

With the power off, insert a DOS diskette in drive A, and turn on the power. If everything was done correctly, the system will boot as normal.

STEP 2

Run the IBM diagnostic routines to check out the features you have just installed. See your IBM *Guide to Operations* manual for instructions. The diagnostic routines do not test the Clock-Calendar feature.

STEP 3

After you have finished the diagnostic routines, insert the DOS diskette that you have installed with the AUTOEXEC.BAT file. See Section 5 or your DOS manual for information on creating an AUTOEXEC.BAT file. Reboot the system (press Ctrl and Alt simultaneously and hold while pressing Del). The ASTCLOCK program should come up and display the current time and date. In most cases the clock should give the correct time with the exception of time zone differences. Use the SETCLOCK program to set/reset the clock on your SixPakPlus.

(This page intentionally left blank.)



SECTION 8

USER UPGRADE INFORMATION

The SixPakPlus card is designed to allow easy user upgrade. To order the optional items, please use the following part numbers:

Game Port Option

Order part number SPK-000G for the Game Adapter Port option kit which consists of two ICs and a cable.

NOTE

Although the AST SixPakPlus card is designed for easy user expansion, the warranty coverage applies only to the configuration of the board as originally shipped from the factory. The expansion sockets and any additional expansion-related components are not warranted.

(This page intentionally left blank.)

APPENDIX A

RECOMMENDED SERIAL PORT CABLING

This section contains pin connections and wiring configurations for interfacing the serial port on your SixPakPlus to specific serial printers and modems. For information on wiring other product interfaces, consult Appendix C of this manual and your serial device's manual, or call your printer manufacturer and tell them you wish to connect to an IBM PC Asynchronous Serial Port.

DTE Type Cabling

The following interface diagrams refer to DTE interfaces only, such as the serial port on the SixPakPlus.

Suggested wiring to modem devices (Hayes Stack Smart modem, Novation Cat, UDS, etc):

SixPakPlus Serial Port Connector	Modem Port Connector
1-----	1
2-----	2
3-----	3
4-----	4
5-----	5
6-----	6
7-----	7
8-----	8
20-----	20
22-----	22

Use a DB25S (female/socket) connector for the SixPakPlus side and a DB25P (male/plug) connector for the modem side.

Suggested wiring for NEC 7700 series, TI 810 series, Epson MX-100-3, Brother HR-1, OKIDATA Microline 83A, 84, and Anadex 9501 serial printers:

SixPakPlus Serial Port Connector	Printer Port Connector	
1-----	1	
2-----	3	
3-----	2	
4-----	5	
5-----	11	{ TI, Brother, Epson, OKIDATA only NEC, Anadex only
5-----	19	
6 & 8-----	20	
7-----	7	
20-----	6 & 8	

Pins 6 and 8 on the PC side are wired together and connected to pin 20 from the printer. The same is true at the printer side.

This wiring allows the printer to inform the PC that its receiving buffer is full. Use a DB25S (female/socket) connector for the SixPakPlus serial port and a DB25P (male/plug) for the printer. If you have a printer like the NEC 7720 (which requires a DB25S), you will need to use an adapter to hook up to the port.

Suggested wiring for the Qume Sprint 9/45, 9/55 printers:

SixPakPlus Serial Port Connector	Printer Port Connector
1-----	1
2-----	3
3-----	2
4-----	5
5-----	20
6 & 8-----	4
7-----	7
20-----	6 & 8

This wiring allows the Qume printer to inform the PC that its receiving buffer is full. Use DB25S (female/socket) for the SixPakPlus serial port and a DB25P (male/plug) for the Qume printer.

Suggested wiring for CRTs and printers running at low baud rates (110-300):

SixPakPlus Serial Port Connector	CRT/Printer Port Connector
1-----	1
2-----	3
3-----	2
7-----	7
4 & 5	---
6 & 8-----	20
-----	5 & 20 or 4 & 5 if needed

This wiring does not use standard EIA RS-232C handshaking; however, it should work with most CRTs and some printers. Use DB25S (female/socket) for the SixPakPlus serial port and a DB25P (male/plug) for the CRT or printer (in most cases). Notice that pins 5 and 20, or 4 and 5 on the CRT side can be wired together. Consult the user's manual for your CRT or printer for your specific configuration.

Suggested wiring for the Diablo 620 printer:

SixPakPlus Serial Port Connector	Diablo 620 Serial Port Connector
1-----	1
2-----	3
3-----	2
5-----	4
7-----	7
6 & 8-----	20
20-----	6

This arrangement allows the Diablo to inform the PC side of the interface that its receive buffer is full. Notice that pins 6 and 8 on the PC side are wired together, and then commonly connected to pin 20 on the Diablo 620 side.

There are several different versions of the Diablo 630 printer available. We have had the best success with the following wiring for the serial interface:

SixPakPlus Serial Port Connector	Diablo 630 Serial Port Connector
1-----	1
2-----	3
3-----	2
5-----	11
7-----	7
6 & 8 & 20-----	6 (or 6 & 4)

If the above wiring does not work for you, you will need to contact Diablo or the dealer from whom you purchased the printer.

Suggested wiring for the Smith-Corona TP-1, Epson MX-80 serial printer, and IDS Prism serial printers:

SixPakPlus Serial Port Connector	Printer Port Connector
1-----	1
2-----	3
3-----	2
4-----	5
5-----	4 (TP-1 only)
5-----	20 (MX-80, IDS only)
6 & 8 & 20	---
7-----	7
---	6 & 8 & 20 (TP-1 only)

This arrangement gives these printers sufficient control over output from the PC side of the interface. Notice that pins 6, 8, and 20 are connected to each other on either side of the link for the TP-1. This allows both devices to remain in a ready state, while pins 4 and 5 actually control the flow of data from one side to the other.

Suggested wiring for the Hewlett-Packard H-P 7470A plotter:

SixPakPlus Serial Port Connector	H-P 7470A Serial Port Connector
1-----	1
3-----	2
2-----	3
7-----	7
5-----	20
6 & 8 & 20	---

(This page intentionally left blank)

APPENDIX B

SWITCHING BETWEEN LPT1 AND LPT2

The following program can be used in the .BAT mode to direct printer output, normally designated for the device attached to port LPT1, to instead be routed to the device attached to port LPT2. (The program also directs output, normally designated for the device attached to port LPT2, to instead be routed to the device attached to port LPT1.)

This can be used when your LPT1 printer (call it printer #1) is down for service, or when you desire, say, the type style or speed of the printer attached to LPT2 (call it printer #2). This program allows you to quickly switch between outputs without having to alter your hardware interface or change each line in programs where LPT1 or LPT2 appear as your output port designation.

If your printers are not configured to the same parameters, as defined in the PC-DOS MODE command, it will be necessary to add two MODE statements when switching devices.

You will note that the "swap" program below is written in BASIC. Since the printer port swap is best handled in DOS, it is necessary to invoke BASIC within the .BAT file. No RUN command is required when the BASIC call and the program file name occur on the same line (BASIC LPTSWAP).

The following DOS batch file and BASIC program will redirect printer output from LPT1 to LPT2 or vice versa, depending on which port is being used at the time.

LPTSWAP.BAT (or a name of your choosing) with the following:

```
MODE LPT1:[parameters for printer #2 (if needed)]
MODE LPT2:[parameters for printer #1 (if needed)]
BASIC LPTSWAP
```

LPTSWAP is a BASIC program, as shown below. The comments are included for clarification and need not be included in the actual program:

```
10 DEF SEG=&H40           ' finds port address table
20 A=PEEK (8): B=PEEK (9) ' save LPT1 address
30 POKE 8,PEEK (10): POKE 9,
   PEEK (11)             ' LPT2 address to LPT1
40 POKE 10,A: POKE 11,B  ' LPT1 address to LPT2
50 SYSTEM                ' return to DOS
```

Omit the last statement if you will be LPRINTing from BASIC.

To restore LPT1 to LPT1 AND ALSO to restore LPT2 to LPT2:

Use the same program, LPTSWAP, to restore your parallel printer ports to their original arrangement. Be sure to restore the proper parameters using a new batch file and MODE statements.

LPTRSTR.BAT is as follows:

```
MODE LPT1:[parameters for printer #1 (if needed)]
MODE LPT2:[parameters for printer #2 (if needed)]
BASIC LPTSWAP
```

APPENDIX C

WIRING RS-232 SERIAL INTERFACES

This appendix concerns the wiring of your SixPakPlus Serial communications port to remote devices using the electronic industry association RS-232C standard interface.

AST Research carefully designs its RS-232 interfaces to ensure that the PC's operating system software and hardware will utilize the serial port in a manner consistent with IBM's notions of what the serial port should "look like" to the system. In addition, AST designs its products so they are easy to reconfigure. For example, there is no etch cutting or soldering required to reconfigure a serial port from COM1 to COM2. To make this change you simply move two jumpers to different pairs of pins.

The EIA RS-232C standard describes the arrangement of control and data signals on both sides of a serial communications interface. As a reference point to model the standard on, the RS-232C document describes an ideal case in which a data terminal is connected to a modem. A modem is a MODulator/DEMulator used to connect a terminal to a communications device. The communications device interfaces to a transmission medium (for example, phone lines) which carry the signal to a similar device connected to a port on another DTE port or the communications element of a mainframe computer system (either of which we can call the "remote").

The RS-232C standard provides for various signals to be sent between a data terminal (DTE) and a data communications device (DCE), to control the exchange of data to and from the local modem and local terminal. These signals travel on separate wires from pins on the DTE side (terminal) to pins on the DCE side (modem).

For asynchronous applications such as your SixPakPlus Serial communications port, we are interested in the "states" of only eight or nine (of the twenty-five possible) wires between the DTE (your serial port) and the DCE (a modem or serial printer DCE port).

Let's look at an ideal case set up first so that you will become acquainted with the signal and sequence requirements of the RS-232 standard. In our ideal case scenario, we'll imagine we are connecting the serial port on your AST card (DTE) to a telephone modem (DCE). A correctly configured DCE/DTE interface will be wired "straight across"; i.e., pin 20 on the DTE side will be wired to pin 20 on the DCE side, pin 2 to pin 2, and so forth. Let's see what sort of "handshaking" (the manner in which two devices are set to interact so as to function properly) has to take place.

When the DTE serial port on your PC wants to transmit some data it raises the voltage, or "brings up," pin 20 which is known as DTR (data terminal ready). This voltage travels to pin 20 on the DCE side where, ideally, the DCE modem tells itself that a communications link is being requested by the terminal device. Assuming that an open phone line exists, the DCE brings up two lines on its side of the interface; DSR (data set ready, pin 6) and DCD (data carrier detect, pin 8). When the DTE (remember, that's your PC port) sees voltage at its pins 6 and 8, it is free to bring up pin 4, RTS (request to send). This tells the DCE, in effect, that "I've got data to transmit to you right now!" The DCE checks to make sure it is ready to receive data and, if so, brings up pin 5, CTS (clear to send). The DTE, seeing voltage on its pin 5, starts transmitting on the wire connected to pin 2, TD (transmit data). Any incoming traffic is received at pin 3, RD (receive data). (NOTE: some modems have an automatic answer mode which uses pin 22, the Ring Indicator (RI) to alert the terminal that incoming data is due. The terminal responds with DTR.) One other thing: be sure to wire pins 1 and 7. They are ground wires and can help protect your equipment from damage.

Figure C-1 shows the signals that are used between the DTE and DCE and in which "direction" they travel.

The Ideal: Terminal to modem

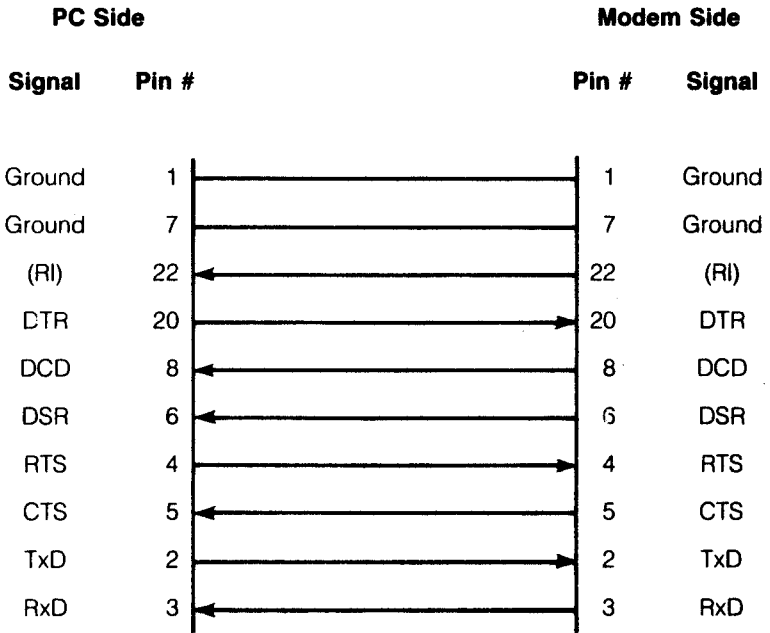

Figure C-1. Ideal Case: DTE to DCE Interface

Notice that the **INPUT** signals on the DTE side of the interface are DCD, DSR, CTS, and RxD. Also, the DTE has **OUTPUT** DTR, and RTS. These are the signals which must be handled by the interface before the DTE can transmit or receive data.

Now notice the **SEQUENCE** in which these signals occur (top to bottom in Figure A). From the DTE's standpoint, he must send DTR, see DCD, see DSR, send RTS, and see CTS before he can transmit or receive data. That is, the **INPUTS** must have voltage applied to them or the interface cannot become operational. (The outputs matter only in that they are inputs to the DCE side of the interface.) The hardware which controls the DTE serial interface will not release data to the communications link until the proper *set* and *sequence* of signals has been *received*.

One other concept: you can think of certain pins on one side of the interface as being "functional pairs". When the AST serial port sends DTR, it expects to see DSR (and DCD) raised in response. DTR and DSR are signal and response to one another. For this reason we will think of them as a pair. The same is true of RTS and CTS, and of TxD and RxD. This concept will be taken up again later in our discussion.

NOW LET'S LOOK AT A TYPICAL (NON-IDEAL) CASE

DTE to DTE Interfaces

As is often the case, many devices, such as serial printers, are set up as DTEs. To output data from your PC serial port (also DTE) to a serial printer or other DTE device requires the wiring of a DTE to DTE interface. Such an interface must fool each side of the link into thinking that it is receiving "response" inputs from a DCE. As mentioned above, not only must the input voltages be present, but they must become present in the correct sequence (although, this varies from device to device).

To illustrate, let's look at the case presented in Figure C-2.

Notice that the necessary input signals have been supplied to both sides. DCD, DSR, and CTS have voltage applied to them on either side. The integrated circuit which controls the PC side (INS 8250) is fairly flexible in reading the sequence of inputs. That is why we can "drive" CTS with DTR from the printer's side. You'll notice that this is the only sequencing rule that we've broken. Why have we done this? The Qume manual explains that when the printer's receive buffer is about to fill up it "drops" its DTR signal. Since we don't want to lose data by overflowing the printer's receive buffer, we need to immediately halt the output of data from the PC side of the interface. The best way to do this is to immediately drop the clear to send (CTS) input on the PC side. By having the printer's DTR output drive the PC's CTS input, we can ensure that this kind of control will occur. The remainder of the interface will "idle" until the printer "raises" DTR again. (Remember, this is a specific case for Qume serial printers.)

Example of a Specific DTE to DTE Interface

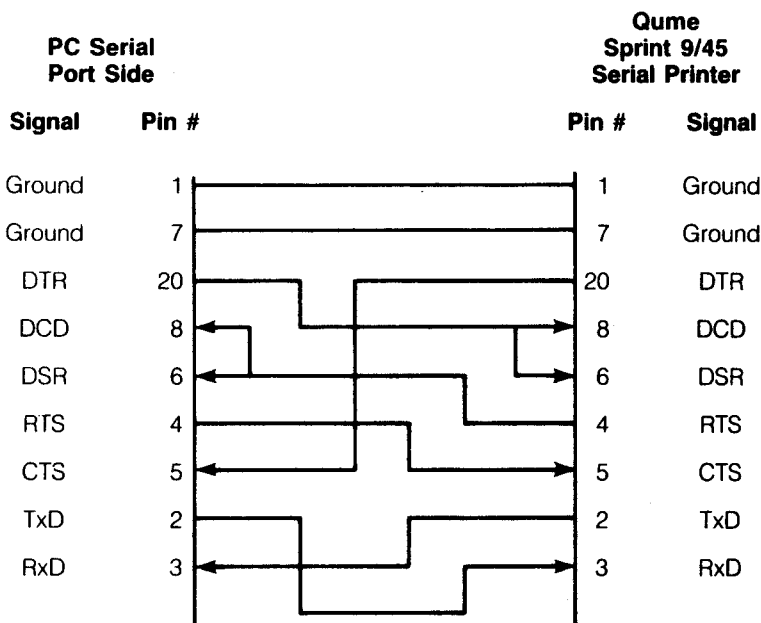

Figure C-2. Typical (Non-Ideal) Case: DTE to DCE Interface

Figure C-3 contains another example of interfacing a serial DTE printer to the PC's SixPakPlus card Serial port.

In this case, the printer uses line 19, a Secondary Request to Send (SRTS), instead of pin 4. Other than this oddity, careful examination of the interface will show that all of our DTE input and sequence rules have been followed. On both sides DCD, DSR, and CTS are raised, and in the top-down sequence we are generally trying to follow for these signals.

Another nice thing about this particular wiring is that all of the pins are driven by their functional counterparts on the other side of the interface. You'll recall in our Ideal Case scenario (see Figure C-1) we mentioned functionally related "pairs" of pins (DTR/DSR, RTS/CTS, and TxD/RxD). Figure C-3 shows that an element of a pair on one side of the interface is driving its partner element on the

AST Serial Port DTE to NEC 7700 Series Serial DTE Printer

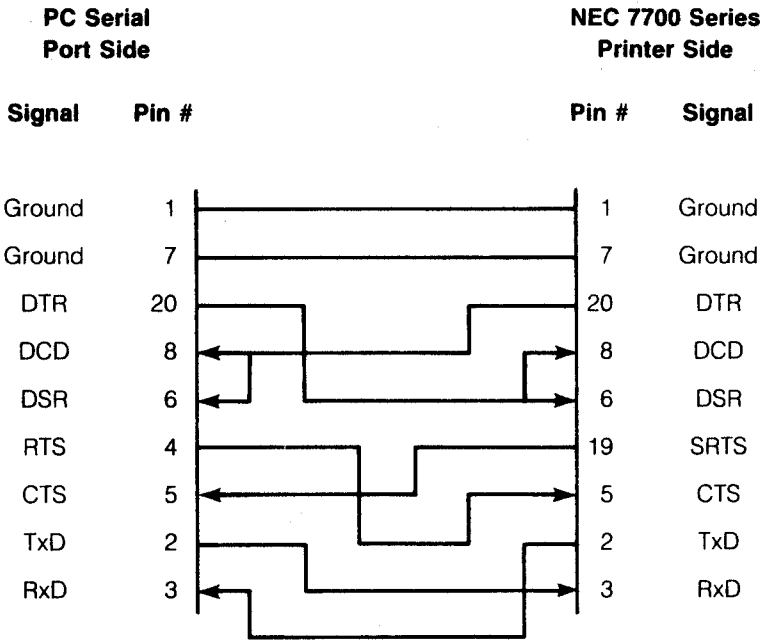

Figure C-3. DTE to NEC 7700 Printer Interface

other side of the interface. When sequence is important, this is a good way to tell whether or not your interface will work.

Any serial device manual worth the paper it's printed on will tell you how the device uses the RS-232C line signals and which pin numbers supply which signals. If your device manual doesn't give you enough information to go on, call or write the device company and tell them you are interfacing their product to an IBM Personal Computer Asynchronous Serial Port. Serial ports on all AST cards are set up to be functionally identical to the IBM product. If you do have problems, your dealer can usually assist you. Your dealer can also direct you to a parts store which carries the products you need to construct an interface cable. Be sure you buy the correct type of 25 pin connectors (male or female) to connect both ends properly.

Your SixPakPlus Serial communications port end requires a DB25S, female or socket type connector.

To properly wire your serial interface signals, we suggest you use the form shown in Figure C-4 as a design aid.

Helpful Hint: If you have several different serial devices which will be using your serial port, make all your wiring translations in small assemblies. Then you can use the same long cable to connect your PC to any of these devices.

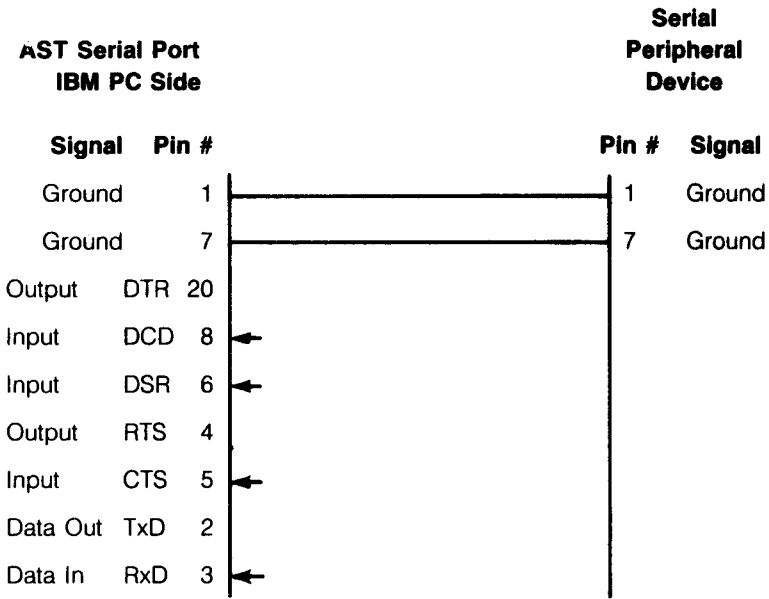

Figure C-4. Serial Interface Form

(This page intentionally left blank)

APPENDIX D

PATCH PROCEDURES

The following patches correct problems in the DOS 1.1 versions of DISKCOPY and DISKCOMP.

Create a DOS diskette which contains the DEBUG utility and the program to be patched. (Your DOS manual explains the use and function of the DEBUG utility.) Place this disk in drive A and boot the computer. After the patch is applied, the new (patched) version can be copied over to your working diskettes. **DO NOT APPLY PATCHES TO YOUR MASTER DISKETTES — USE BACKUPS ONLY! TEST THE PATCHED VERSION BEFORE ACTUALLY USING IT!**

In the following procedures, the user enters all boldface text, exactly as shown; **BE SURE TO INCLUDE SPACES**. The computer responds with all other output. Refer to your DOS manual for more information on using the DEBUG command.

Patch for DOS 1.1 Version of DISKCOPY Utility

The following patch fixes a problem in DISKCOPY when you have a large amount of memory and double-sided drives.

```
A <DEBUG DISKCOPY.COM <enter >
-E861 E8 74 00 <enter >
-E8D8 3D 51 00 72 02 B0 50 A2 36 05 C3 <enter >
-RCX <enter >
CX 07D8
:7E3 <enter >
-W <enter >
Writing 07E3 bytes
-Q <enter >
```

```
A >
```

Patch for DOS 1.1 Version of DISKCOMP Utility

The following patch fixes a problem in DISKCOMP when you have a large amount of memory and double-sided drives.

```
A>DEBUG DISKCOMP.COM<enter>
-E6EC E8 79 00<enter>
-E768 3D 51 00 72 02 B0 50 A2 95 04 C3<enter>
-RCX<enter>
CX 0668
:673<enter>
-W<enter>
Writing 0673 bytes
-Q<enter>

A>
```

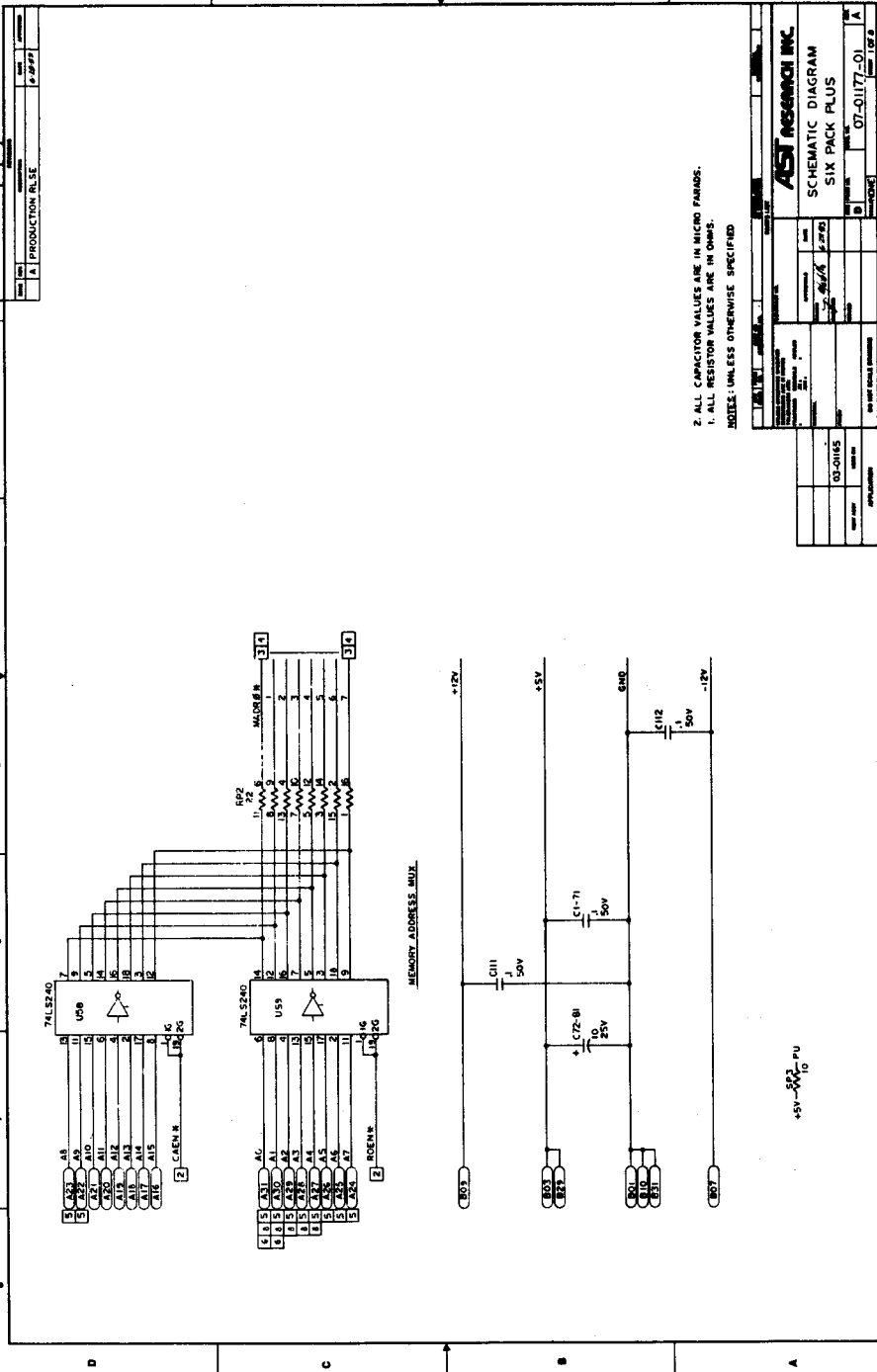

REV	DATE	BY
A	10-29-88	
A PRODUCTION ALSE		

REV	DATE	BY
A	07-01-77	
SIX PACK PLUS		

AST RESEARCH INC.
SIX PACK PLUS
07-0177-01

2. ALL CAPACITOR VALUES ARE IN MICRO FARADS.
1. ALL RESISTOR VALUES ARE IN OHMS.
NOTES: UNLESS OTHERWISE SPECIFIED

REV	DATE	BY
A	07-01-77	
SIX PACK PLUS		

AST RESEARCH INC.
SIX PACK PLUS
07-0177-01

2. ALL CAPACITOR VALUES ARE IN MICRO FARADS.
1. ALL RESISTOR VALUES ARE IN OHMS.
NOTES: UNLESS OTHERWISE SPECIFIED

REV	DATE	BY
A	07-01-77	
SIX PACK PLUS		

AST RESEARCH INC.
SIX PACK PLUS
07-0177-01

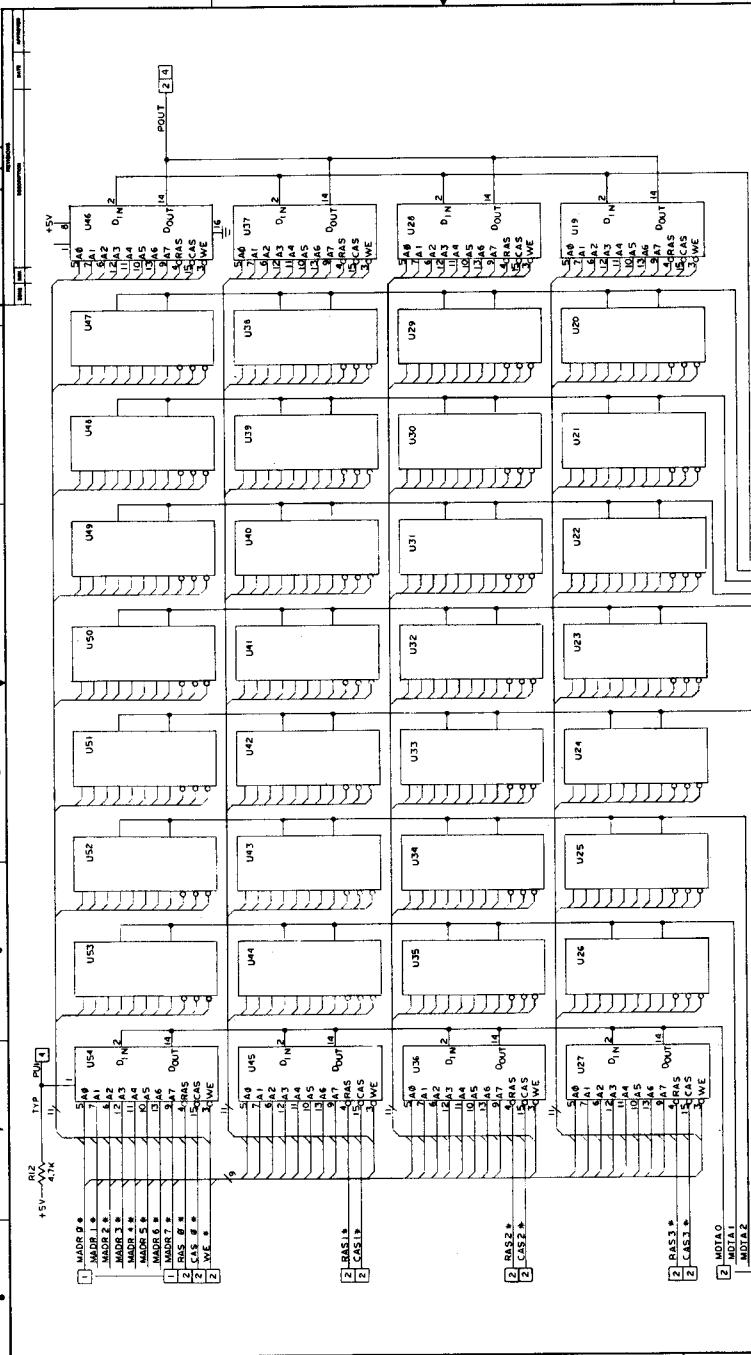

ASB RESISTANCE INC. IRVINE, CA.	
SCHEMATIC DIAGRAM SIX PACK PLUS	
PART NO. 07-01177-01	REV. 3
DATE	DRAWN BY
CHECKED BY	APPROVED BY
DESIGNED BY	TESTED BY
MANUFACTURED BY	ASSEMBLED BY

64/256 MEMORY ARRAY
A164 250 N 5

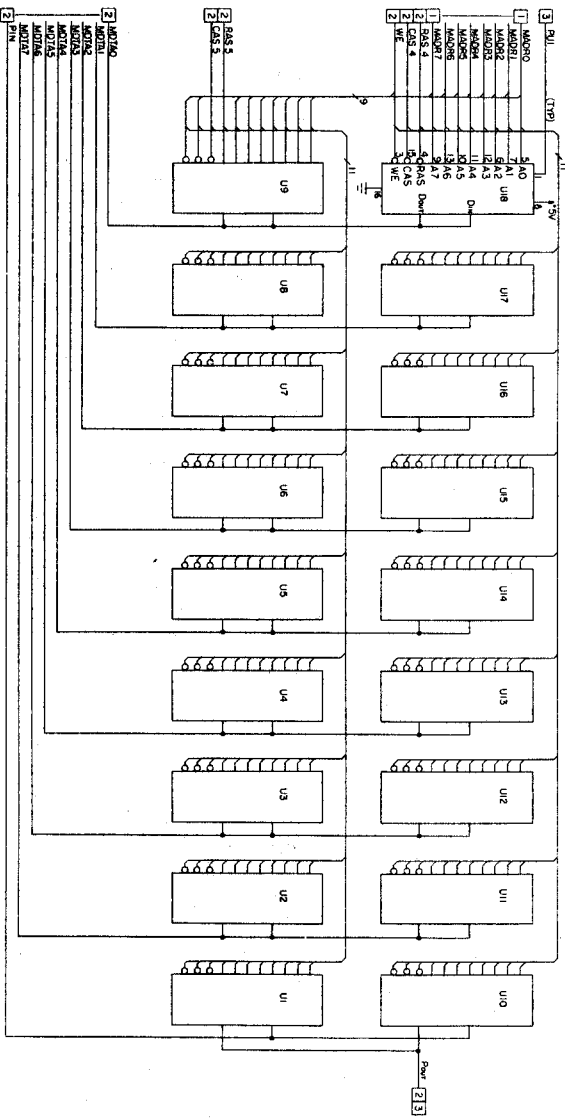

AST Research Inc SCHEMATIC DIAGRAM SIX PACK PLUS	
DATE: 07/17/07 DRAWN BY: [] CHECKED BY: [] APPROVED BY: []	PART NO.: [] REV: [] QTY: []
TITLE: [] PROJECT: [] PART: []	REV: [] QTY: []

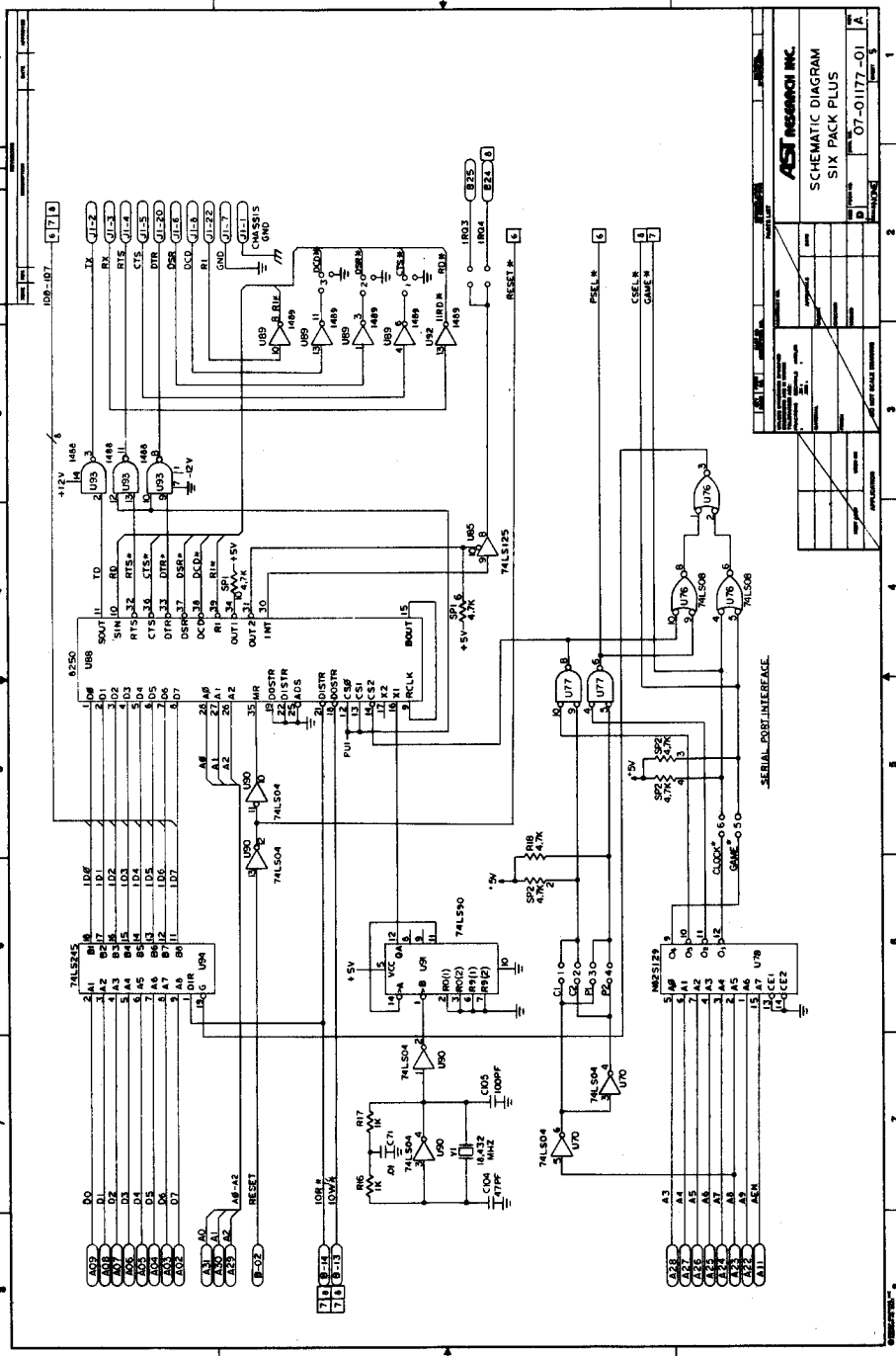

AST RESOURCES INC
SCHEMATIC DIAGRAM
SIX PACK PLUS

REV 1
DATE 07-01-77
DRAWN BY J. J. BURKE
CHECKED BY R. J. BURKE
PROJECT NO. 07-01177-01

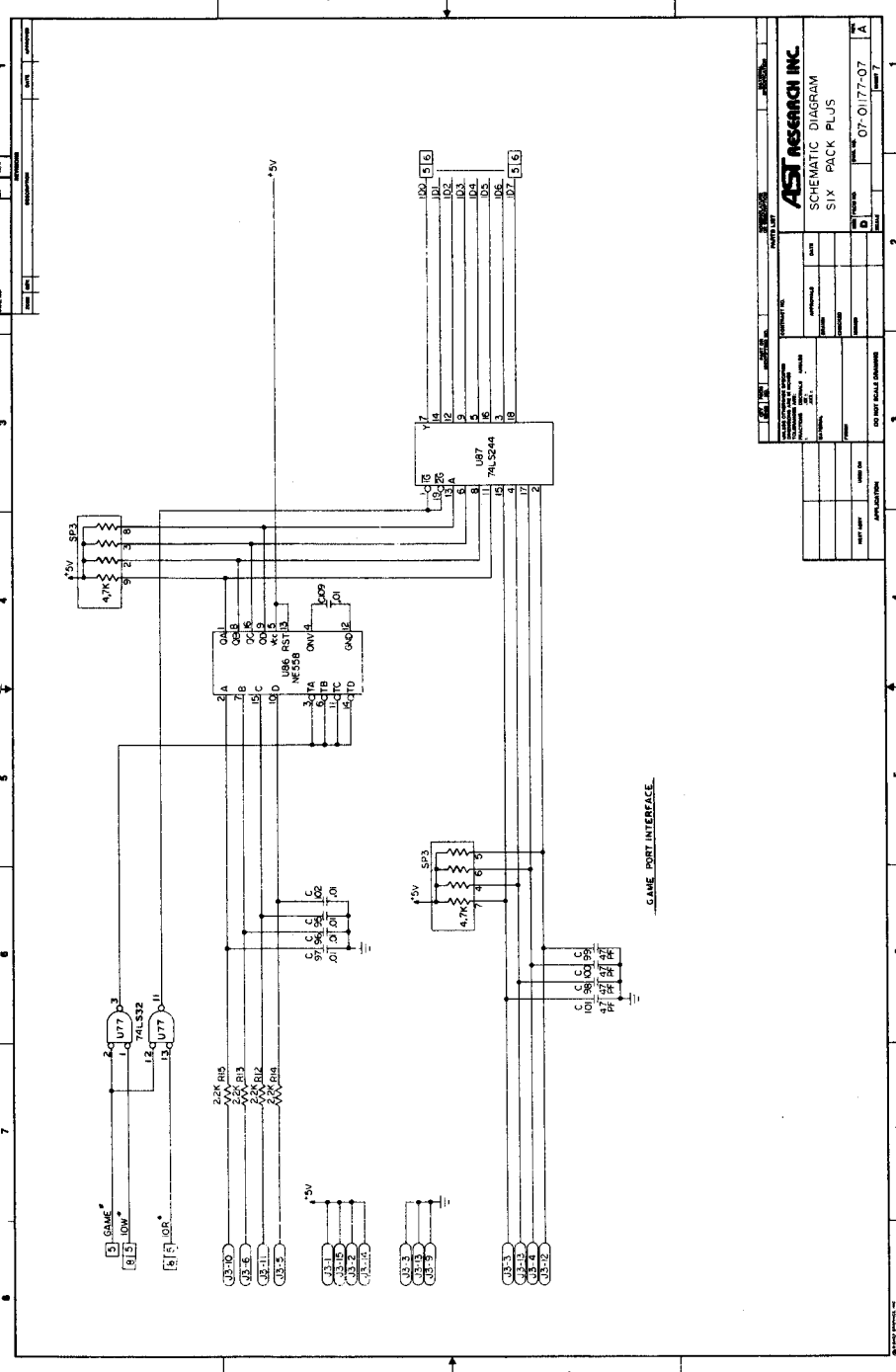

AST RESEARCH INC. SCHEMATIC DIAGRAM SIX PACK PLUS	
PROJECT NO. PART 1 LIST	DATE APPROVED BY DRAWN BY CHECKED BY DESIGNED BY
PART NAME GAME PORT INTERFACE	PART NO. 07-0177-07
REV. NO. 1	REV. DATE 7/80

1
 2
 3
 4
 5
 6
 7
 8
 9
 10
 11
 12
 13
 14
 15
 16
 17
 18
 19
 20
 21
 22
 23
 24
 25
 26
 27
 28
 29
 30
 31
 32
 33
 34
 35
 36
 37
 38
 39
 40
 41
 42
 43
 44
 45
 46
 47
 48
 49
 50
 51
 52
 53
 54
 55
 56
 57
 58
 59
 60
 61
 62
 63
 64
 65
 66
 67
 68
 69
 70
 71
 72
 73
 74
 75
 76
 77
 78
 79
 80
 81
 82
 83
 84
 85
 86
 87
 88
 89
 90
 91
 92
 93
 94
 95
 96
 97
 98
 99
 100

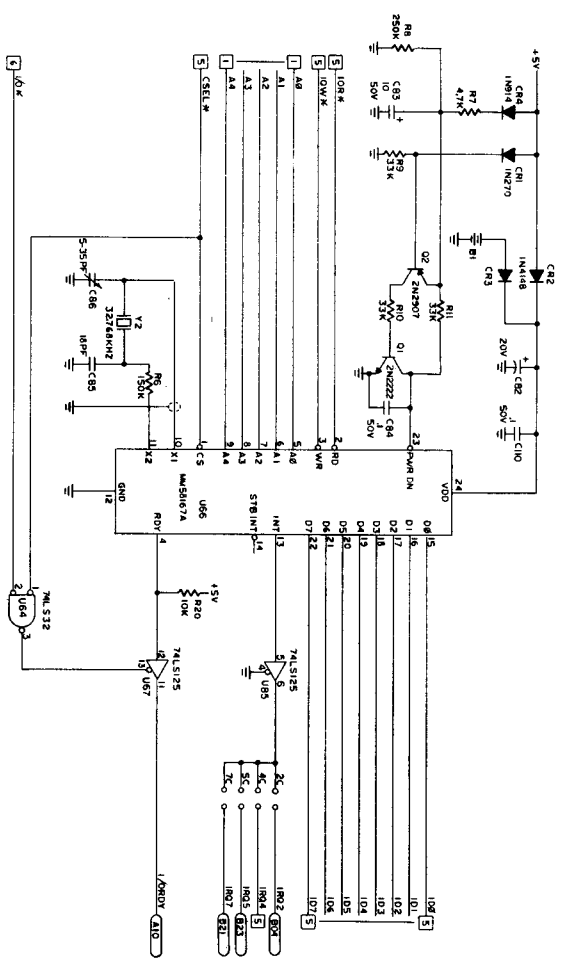

REAL TIME CLOCK

ASJ INFORMATION INC. SCHEMATIC DIAGRAM SIX PACK PLUS	
DATE: 07-01-77 DRAWN BY: [] CHECKED BY: []	REV. 1 07-01-77-01 1

LIMITED WARRANTY

AST Research, Inc. warrants to the original purchaser of this AST Research, Inc. product that it is to be in good working order for a period of 1 year from the date of purchase from AST Research, Inc. or an authorized AST Research, Inc. dealer. Should this product, in AST Research, Inc.'s opinion, malfunction during the warranty period, AST will, at its option, repair or replace it at no charge, provided that the product has not been subjected to misuse, abuse or non-AST authorized alterations, modifications and/or repairs.

Products requiring Limited Warranty service during the warranty period should be delivered to AST with proof of purchase. If the delivery is by mail, you agree to insure the product or assume risk of loss or damage in transit. You also agree to prepay shipping charges to AST.

ALL EXPRESS AND IMPLIED WARRANTIES FOR THIS PRODUCT INCLUDING, BUT NOT LIMITED TO, THE WARRANTIES OF MERCHANTABILITY AND FITNESS FOR A PARTICULAR PURPOSE ARE LIMITED IN DURATION TO THE ABOVE 1 YEAR PERIOD. Some states do not allow limitations on how long an implied warranty lasts, so the above limitations may not apply to you.

UNDER NO CIRCUMSTANCES WILL AST RESEARCH, INC. BE LIABLE IN ANY WAY TO THE USER FOR DAMAGES, INCLUDING ANY LOST PROFITS, LOST SAVINGS OR OTHER INCIDENTAL OR CONSEQUENTIAL DAMAGES ARISING OUT OF THE USE OF, OR INABILITY TO USE, SUCH PRODUCT. Some states do not allow the exclusion or limitation of incidental or consequential damages for consumer products, so the above limitations or exclusion may not apply to you.

THIS WARRANTY GIVES YOU SPECIFIC LEGAL RIGHTS, AND YOU MAY ALSO HAVE OTHER RIGHTS WHICH MAY VARY FROM STATE TO STATE.

The limited warranty applies to hardware products only.

