



USER MANUAL

Disclaimer

All pictures contained in this documentation are example images only. The images may vary depending on the product and software version. Information presented in this documentation has been carefully checked for reliability; however, no responsibility is assumed for inaccuracies. The information contained in this documentation is subject to change without notice.

Copyright and Trademark Information

© 2017 by AVerMedia Technologies, Inc. All rights reserved. No part of this publication, in whole or in part, may be reproduced, transmitted, transcribed, altered or translated into any language in any form by any means without the written permission of AVerMedia Technologies, Inc. Information and specification contained in this manual are subject to change without notice and do not represent a commitment on the part of AVerMedia.

For more information, please visit www.avermedia.com.

AVerMedia and RECcentral™ are trademarks or registered trademarks of AVerMedia Technologies, Inc.

Headquarters

Address No.135, Jian 1st Rd., Zhonghe Dist., New Taipei City 23585, Taiwan

Website www.avermedia.com

Support www.avermedia.com/support

Telephone +886-2-2226-3630

▼ PREPARATION

Inside the Box

Check that all these items are included.



Live Gamer Portable 2 Plus



HDMI Cable



USB Cable



4-Pole 3.5 mm
Audio Cable



Quick Guide

RECentral

RECentral is the streaming/recording software designed for Live Gamer Portable 2 Plus.

Download it from:

q.avermedia.com/gc513-recentral

Parts and Ports

1	RECentral Button + LED
2	4-Pole 3.5 mm Port (Controller)
3	4-Pole 3.5 mm Port (Headset)
4	Audio Buttons + LED
5	Mode Switch
6	HDMI Output
7	HDMI Input
8	Micro-USB Port
9	microSD Card Slot

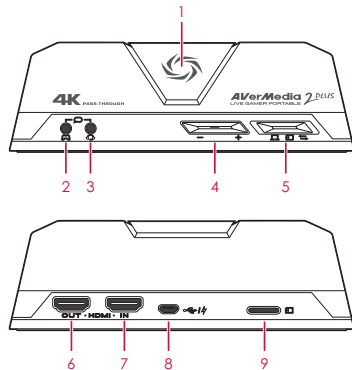

▼ INSTALLATION

Front

Connect your headset and game controller to the audio ports to capture both your commentary and party chat.

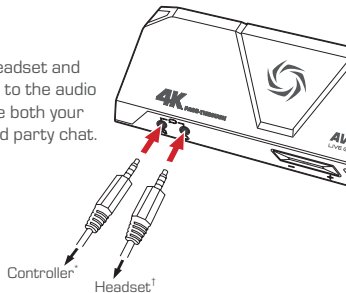

* PS4 and Xbox One recommended.

† Standard gaming headset recommended.

Back

Connect your devices to the back of LGP2+ as shown.

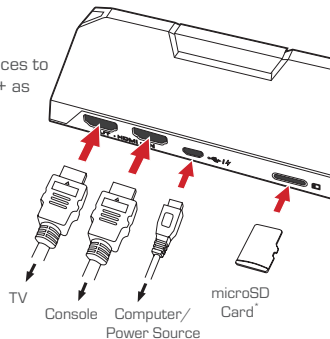

**PLEASE DO NOT USE HDMI SPLITTERS
TO BYPASS COPY PROTECTION.**

* Not included.

▼ OPERATION

RECentral Button

Press once to start recording or streaming, press again to stop. You can configure these in RECcentral.



The LED indicates the state of LGP2+:

Constantly On



Ready

Breathing



Streaming

Flashing



Busy



Error*



Recording



Storage Low

Mode Switch



Flick the switch to use LGP2+ between three modes.



PC Mode: Stream and record on PC



PC-Free Mode: Record to microSD card on the move



Storage Mode: Access microSD card from PC

Audio Buttons

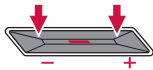

Press **-** or **+** to adjust the microphone volume.

- (On): Muted

- (Flash Twice): Limit Reached

Press and hold either button to switch between two modes.

- (On): Pass-Through Mode

- (Flashing): Monitor Mode*

* Check your signal, network connection, resolution, storage, or microSD card.

* Use Monitor Mode to check the balance of your output volume.

▼ ERSTE SCHRITTE

Paketinhalt

Vergewissern Sie sich, dass alle diese Elemente beiliegen.



Live Gamer Portable 2 Plus



HDMI-Kabel



USB-Kabel



4-poliges 3,5-mm-
Audiokabel



Schnellanleitung

RECentral

RECentral ist die Streaming-/ Aufnahme-Software für Live Gamer Portable 2 Plus.

Download von:

q.avermedia.com/gc513-recentral

Teile und Anschlüsse

1	RECentral-Taste + LED
2	4-poliger 3,5-Anschluss (Regler)
3	4-poliger 3,5-Anschluss (Kopfhörer)
4	Audio-Tasten + LED
5	Modus-Schalter
6	HDMI-Ausgang
7	HDMI-Eingang
8	Micro-USB-Anschluss
9	microSD-Kartenschlitz

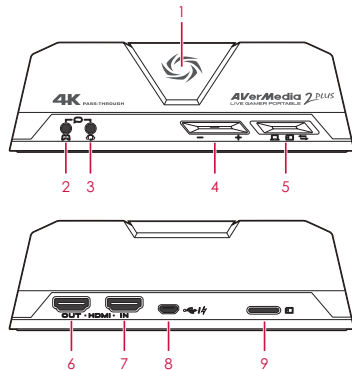

▼ INSTALLATION

Vorne

Verbinden Sie Ihren Kopfhörer und den Game-Controller mit den Audio-Anschlüssen, um Ihre Kommentare und Chats mit anderen zu erfassen.

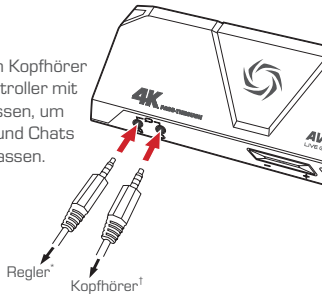

* PS4 und Xbox One empfohlen.

† Standard Gaming Headset wird empfohlen.

Zurück

Verbinden Sie Ihre Geräte, wie gezeigt, an der Rückseite von LGP2+.

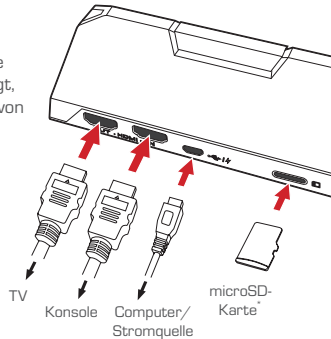

* Nicht enthalten.

▼ BEDIENUNG

RECentral-Taste

Einmal drücken zum Start der Aufnahme oder des Streams; erneut Drücken zum Beenden. Konfiguration in RECcentral.



Die LED zeigt den LGP2+-Status:

Konstant ein



Bereit



Fehler*

Atmen



Streamen



Aufnehmen

Blitzen



Belegt



Disk voll

* Prüfen Sie das Signal, die Netzwerkverbindung, Auflösung, Speicher oder die Micro SD Karte.

Modus-Schalter



Legen Sie den Schalter um, um LPG2+ in einem von drei Modi zu verwenden.



PC-Modus: auf dem PC streamen oder aufnehmen



PC-Free Modus: Aufnahme auf die microSD-Karte im Betrieb



Speichermodus: PC-Zugriff auf die microSD

Audio-Tasten



Drücken Sie **-** oder **+** um die Mikrofonlautstärke anzupassen.

- (Ein): Stumm geschaltet **-** (Zweimal blinken): Limit erreicht

Ein beliebige Taste gedrückt halten, um zwischen zwei Modi umzuschalten.

- (Ein): Pass-Thru-Modus **-** (Blitzen): Monitormodus*

* Im Monitormodus prüfen Sie die Balance der Ausgabelautstärke

▼ Preparación

Dentro de la caja

Revisa que todos estos componentes están incluidos.



Live Gamer Portable 2 Plus



Cable HDMI



Cable USB



Cable de audio de
3,5 mm tetrapolar



Guía Rápida

RECentral

RECentral es el software de transmisión/grabación diseñado para Live Gamer Portable 2 Plus.

Descárgalo en:

q.avermedia.com/gc513-recentral

Partes y Puertos

1	Botón de RECentral + LED
2	Conector de 3,5 mm tetrapolar (controlador)
3	Conector de 3,5 mm tetrapolar (auriculares)
4	Botones de audio + LED
5	Selector de modo
6	Salida HDMI
7	Entrada HDMI
8	Puerto micro USB
9	Ranura de tarjeta microSD

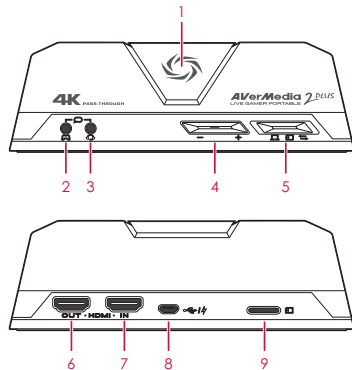

▼ Instalación

Parte delantera

Conecta los auriculares y el dispositivo de juego a los puertos de audio para capturar tus comentarios y chat de grupo.



* Se recomiendan PS4 y Xbox One.

† Standard gaming headset recommended.

Parte trasera

Conecta tus dispositivos a la parte trasera de la LGP2+ como se muestra en la imagen.

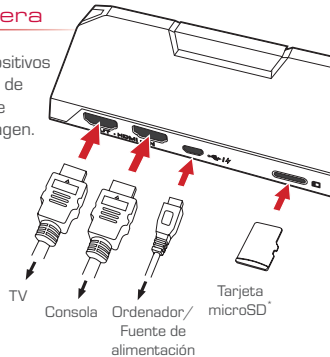

* No se incluye.

▼ USO

Botón de RECentral

Pulsa una vez para iniciar la grabación o transmisión. Pulsa otra vez para detener la grabación o transmisión. Puedes configurarlo en RECentral.



El LED indica el estado de la LGP2+:

Luz fija	Progresiva	Intermitente
Listo	Transmisión en curso	Ocupado
Error*	Grabación en curso	Disco lleno

* Comprueba la conexión de red o inserta una tarjeta microSD.

Selector de modo

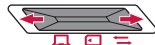

Acciona el interruptor para alternar entre los tres modos de la LGP2+.

- Modo PC:** transmite y graba en PC
- Modo sin PC:** graba en una tarjeta microSD dondequiera que estés
- Modo de almacenamiento:** accede a la tarjeta microSD desde un PC

Botones de audio



Pulsa **-** o **+** para ajustar el volumen del micrófono.

(Luz fija): en silencio (Parpadeo doble): límite alcanzado

Mantén pulsado uno u otro dos botones para alternar entre dos modos.

(Luz fija): Pass-Through (Intermitente): Monitor*

* Utiliza Modo monitor para comprobar el equilibrio del volumen de salida.

▼ PREPARATION

À l'intérieur de la Boîte

Veuillez vérifier que tous les éléments sont inclus.



Live Gamer Portable 2 Plus



Câble HDMI



Câble USB



Câble audio, 4
pôles de 3,5 mm



Guide d'installation
rapide

RECentral

RECentral est le logiciel de diffusion/enregistrement conçu pour le Live Gamer Portable 2 Plus.

Téléchargez-le depuis:
q.avermedia.com/gc513-recentral

Éléments et Connectique

1	Bouton RECentral + DEL
2	Connecteur (contrôleur) de 3,5 mm, à 4 pôles
3	Connecteur (contrôleur) de 3,5 mm, à 4 pôles
4	Bouton audio + DEL
5	Bouton de mode
6	Sortie HDMI
7	Entrée HDMI
8	Port Micro-USB
9	Rainure de carte microSD

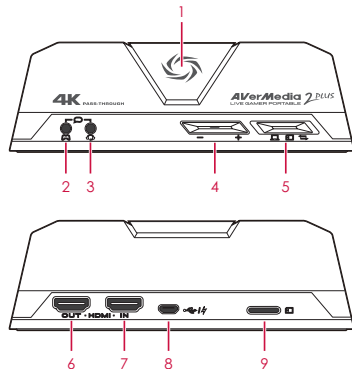

▼ INSTALLATION

Face

Connectez vos écouteurs et le contrôleur du jeu aux ports audio pour capturer vos commentaires et les conversations de la fête.

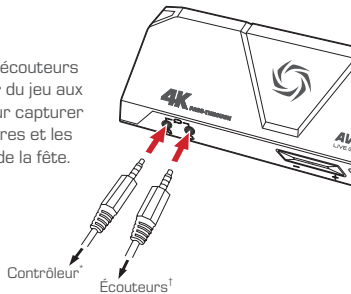

* PS4 et Xbox One recommandées.

† Nous recommandons l'utilisation d'un casque gaming standard.

Arrière

Connectez vos dispositifs à l'arrière du LGP2+ comme indiqué.

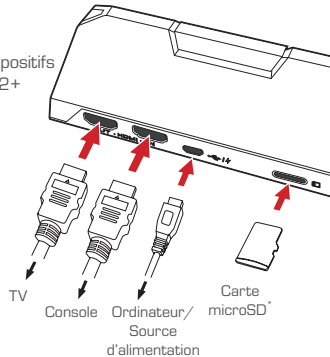

* Non incluse.

▼ UTILISATION

Bouton RECentral

Appuyez une fois pour commencer l'enregistrement ou la diffusion, appuyez de nouveau pour arrêter. Vous pouvez configurer ces fonctions dans RECentral.



La DEL indique l'état de LGP2+:

Toujours allumé



Prêt

Respire



Diffusion en cours

Clignote



Occupé



Error*



Enregistrement



Disque plein

* Merci de vérifier la qualité de votre signal, votre connexion, la résolution, votre stockage ou carte microSD.

Bouton de mode



Utilisez le bouton de mode pour faire basculer le LGP2+ entre les trois modes.



Mode PC: diffuser et enregistrer sur PC



Mode sans PC: en déplacement, l'enregistrement se fait sur la carte microSD



Mode de stockage: accédez à la carte Micro SD depuis le PC

Bouton audio



Appuyez sur — ou + pour régler le volume du micro.

— (On): Silence

— (Clignote deux fois): Limite atteinte

Appuyer et maintenir l'un des deux boutons pour basculer entre les modes.

— (On): Mode de transfert — (Clignote): Mode de suivi*

* Utiliser le mode de suivi pour vérifier la balance du volume de votre sortie

▼ PREPARAZIONE

All'interno della confezione

Controllare che siano presenti tutti i seguenti articoli.



Live Gamer Portable 2 Plus



Cavo HDMI



Cavo USB



Cavo audio da
3,5 mm a 4 poli



Guida rapida

RECentral

RECentral il software di streaming/registrazione progettato per Live Gamer Portable 2 Plus.

Scaricalo da:

q.avermedia.com/gc513-recentral

Parti e componenti

1	Pulsante + LED RECentral
2	Connettore da 3,5 mm a 4 poli (Controller)
3	Connettore da 3,5 mm a 4 poli (Cuffie)
4	Pulsanti + LED audio
5	Interruttore modalità
6	Uscita HDMI
7	Ingresso HDMI
8	Porta Micro-USB
9	Alloggiamento scheda microSD

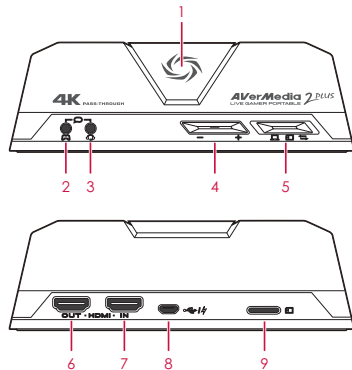

▼ INSTALLAZIONE

Parte anteriore

Collega le tue cuffie e il tuo controller di gioco alle porte audio per catturare sia i commenti che le chat di gruppo.

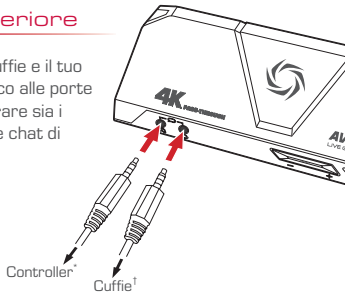

* Articolo consigliato per PS4 che Xbox One.

† Cuffie standard per gaming consigliate.

Parte posteriore

Collega i dispositivi alla parte posteriore del dispositivo LGP2+ come indicato.

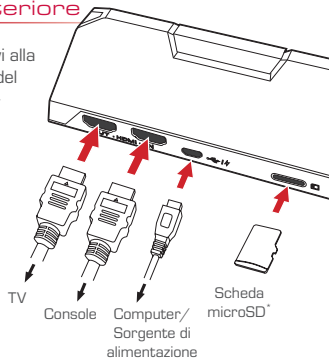

* Non fornita in dotazione.

▼ FUNZIONAMENTO

Pulsante RECentral

Premere una volta per avviare la registrazione o lo streaming, premere nuovamente per interrompere. Sarà possibile eseguire la configurazione in RECentral.



Questo LED indica lo stato di LGP2+:

Sempre acceso



Pronto

Respirazione



Streaming

Lampeggiamento



Impegnato



Errore*



Registrazione



Disco pieno

* Controllare il segnale, la connessione di rete, la risoluzione, l'archiviazione o la scheda microSD.

Interruttore modalità



Muovere l'interruttore per usare LGP2+ fra le tre modalità.



Modalità PC: trasmetti in streaming e registra su PC



Modalità senza PC: registra su microSD mentre sei in movimento



Modalità di accesso: accedi alla scheda microSD dal PC

Pulsanti audio

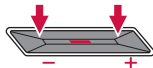

Premere **-** o **+** regolare il volume del microfono.

- (On): audio disattivato **-** (Due lampeggiamenti): limite raggiunto

Premere e tenere premuto uno dei due pulsanti per spostarsi fra le varie modalità.

- (On): Pass-Through **-** (Lampeggiamento): Monitor*

* Usare la Modalità Monitor per controllare il bilanciamento del volume in uscita.

▼ PREPARAÇÃO

Dentro da caixa

Verifique se todos estes itens estão incluídos.



Live Gamer Portable 2 Plus



Cabo HDMI



Cabo USB



Cabo de áudio de 3,5 mm com 4 pólos



Guia rápido

RECentral

RECentral é o software de transmissão/gravação concebido para Live Gamer Portable 2 Plus.

Transfira-o do:

q.avermedia.com/gc513-recentral

Partes e portas

1	Botão RECentral + LED
2	Conetor de 3,5 mm com 4 pólos (controlador)
3	Conetor de 3,5 mm com 4 pólos (auscultador)
4	Botões de áudio + LED
5	Alternância de modo
6	Saída HDMI
7	Entrada HDMI
8	Porta micro-USB
9	Ranhura cartão microSD

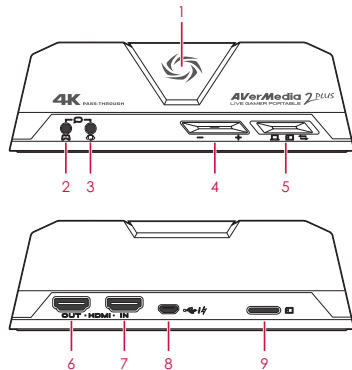

▼ INSTALAÇÃO

Parte frontal

Ligue o seu auscultador e o controlador do jogo às portas de áudio para captar tanto os seus comentários como as conversas.

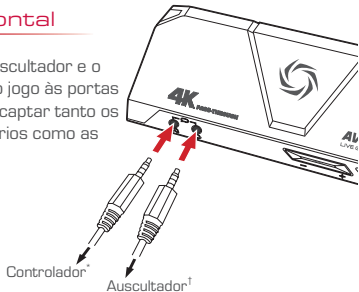

* Recomenda-se PS4 e Xbox One.

† Auscultadores padrão para jogos recomendados.

Parte traseira

Ligue os seus aparelhos à parte traseira do LPG2+, como exibido.

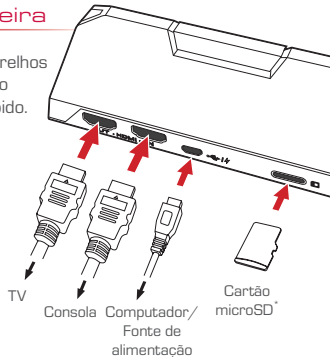

* Não incluído.

▼ FUNCIONAMENTO

Botão RECentral

Prima uma vez para parar a gravação ou transmissão, prima novamente para parar. Pode configurar esses no RECentral.



O LED indica o estado do LPG2+:

Constantemente ligado

Em pausa

A piscar



Pronto



A transmitir



Ocupado



Erro*



A gravar



Disco cheio

Alternância de modo

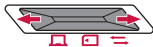

Toque para passar a usar LPG2+ entre três modos.



Modo PC: transmitir e gravar no PC



Modo sem-PC: gravar no cartão microSD ativo



Modo Memória: aceder ao cartão microSD a partir do PC

Botões de áudio

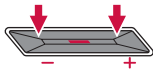

Prima — ou + para ajustar o volume do microfone.

— (Ligado): Silencioso

+ (Pisca duas vezes): limite atingido

Mantenha premido o botão para alternar entre dois modos.

+ (Ligado): Pass-Through

— (A piscar): Monitor*

* Verifique o sinal, ligação de rede, resolução, armazenamento ou cartão microSD.

* Utilize o modo Monitor para verificar a oscilação do seu volume de saída.

▼ PŘÍPRAVA

V krabici

Zkontrolujte, zda jsou přibaleny následující položky.



Live Gamer Portable 2 Plus



Kabel HDMI



USB kabel



4 pólový 3,5 mm
audio kabel



Rychlý průvodce

RECentral

RECentral je software pro vysílání/nahrávání navržený pro Live Gamer Portable 2 Plus.

Sáhněte si ho z:

q.avermedia.com/gc513-recentral

PČásti a porty

1	Tlačítko RECcentral + LED
2	4 pólový 3,5 mm konektor (ovladač)
3	4 pólový 3,5 mm konektor (sluchátka)
4	Tlačítka audio + LED
5	Spínač režimu
6	Výstup HDMI
7	Vstup HDMI
8	Port Micro-USB
9	Port pro kartu microSD

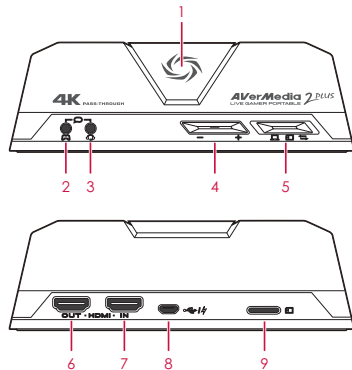

▼ INSTALACE

Přední

Sluchátka a herní ovladač zapojte do audio portů a zaznamenejte jak svůj komentář, tak chat.

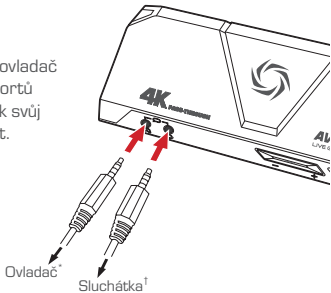

* Doporučeno pro PS4 a Xbox One.

† Doporučena standardní herní sluchátka.

Zadní

Zařízení zapojte do zadní část LGP2+, jak je znázorněno.

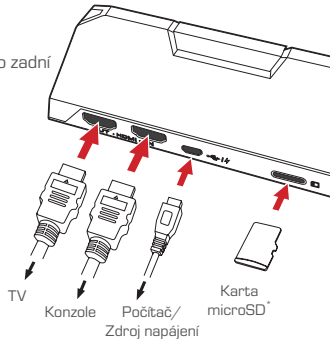

* Není součástí







▼ OVLÁDÁNÍ

Tlačítko RECentral

Stiskněte jednou a spusťte nahrávání nebo vysílání, zastavte opakovaným stisknutím. Konfiguraci můžete provést v RECentral.



LED označuje stav LGP2+:



Trvale svítí	Dýchání	Blikající
 Připravený	 Vysílání	 Zaneprázdnění
 Chyba*	 Nahrávání	 Plný disk

* Zkontrolujte svůj signál, síťové připojení, rozlišení, úložiště nebo kartu microSD.

Spínač režimu



Spínač přepínáte a LGP2+ používejte ve třech režimech.

-  Režim PC: Vysílání a záznam na PC
-  Režim PC-Free: Záznam na kartu microSD během cest
-  Režim úložiště: Přístup na kartu microSD z PC

Tlačítka audio



Stisknutím **—** nebo **+** nastavte hlasitost mikrofonu.

-  (Zap.): Muted
-  (Dvojitě bliknutí): Bylo dosaženo limitu

Stiskněte a přidržte tlačítko a přepněte mezi dvěma režimy.

-  (Zap.): Pass-Through
-  (Blikající): Monitor*

* Režim Monitor použijte k vyvážení hlasitosti výstupu.

VOORBEREIDING

Inhoud van de doos

Controleer of de doos al deze zaken bevat.



Live Gamer Portable 2 Plus



HDMI-kabel



USB-kabel



4-polige 3,5 mm
audiokabel



Snelgids

RECentral

RECentral is the streaming-/opname software ontworpen voor Live Gamer Portable 2 Plus.

Download het van:

q.avermedia.com/gc513-recentral

Onderdelen en aansluitingen

1	RECentral-knop + LED
2	4-polige 3,5 mm aansluiting (controller)
3	4-polige 3,5 mm aansluiting (headset)
4	Audioknoppen + LED
5	Modusschakelaar
6	HDMI-uitgang
7	HDMI-ingang
8	Micro-USB-poort
9	microSD-kaartsleuf

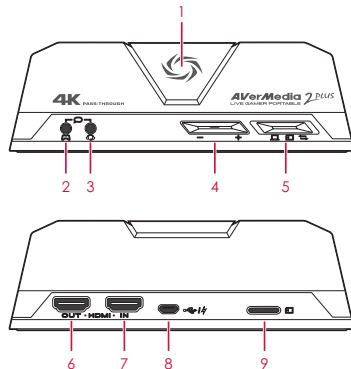

▼ INSTALLATIE

Voorzijde

Sluit uw apparaten aan op de achterzijde van de LGP2+ zoals is aangegeven.

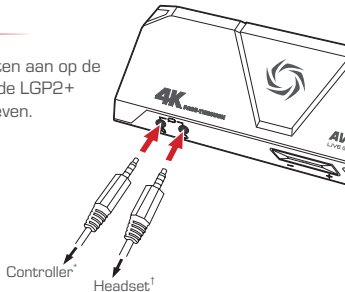

* PS4 en Xbox One aanbevolen.

† Standaard gaming hoofdtelefoon geadviseerd.

Terug

Sluit uw apparaten aan op de achterzijde van de LGP2+ zoals is aangegeven.

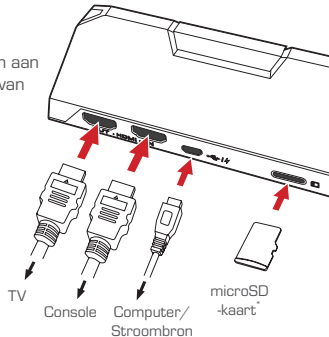

* Niet meegeleverd.

▼ BEDIENING

RECentral-knop

Druk eenmaal om het opnemen of streamen te starten, druk nogmaals om te stoppen. U kunt deze configureren in RECentral.



De led geeft de status van LGP2+ aan:

Doorlopend aan



Gereed

Wisselend



Streamen

Knipperend



Beziet



Fout*



Opnemen



Schijf vol

* Controleer je signaal, netwerk connectie, resolutie, opslag, of MicroSD kaart.

Modusschakelaar



Gebruik de schakelaar om te schakelen tussen de drie modussen van de LGP2+.



PC Modus: streamen en opnemen op pc



PC-loze Modus: opnemen op microSD-kaart onderweg



Opslagmodus: toegang tot de microSD-kaart via pc

Audioknoppen



Druk op **-** of **+** om het microfoonvolume aan te passen.

- (Aan): gedempt

+ (Tweemaal knipperen): limiet bereikt

Houd een van de knoppen ingedrukt om te schakelen tussen de twee modussen.

- (Aan): Doorvoer

+ (Flashing): Monitor*

* Gebruik de monitormodus om de balans van uw uitgangsvolume te controleren.

▼ PRZYGOTOWANIE

W pudełku

Sprawdź, czy poniższe elementy zawarte są w pakiecie.



Live Gamer Portable 2 Plus



Kabel HDMI



Kabel USB



4-biegunowy kabel
audio 3.5 mm



Szybki
przewodnik

RECentral

RECentral to oprogramowanie do strumieniowania/nagrywania przeznaczone do Live Gamer Portable 2 Plus.

Pobierz z:

q.avermedia.com/gc513-recentral

Elementy i porty

1	Przycisk RECentral + LED
2	4-biegunowe złącze 3,5 mm (kontroler)
3	4-biegunowe złącze 3,5 mm (słuchawki)
4	Przyciski audio + LED
5	Przełącznik trybu
6	Wyjście HDMI
7	Wejście HDMI
8	Port Micro-USB
9	Gniazdo karty microSD

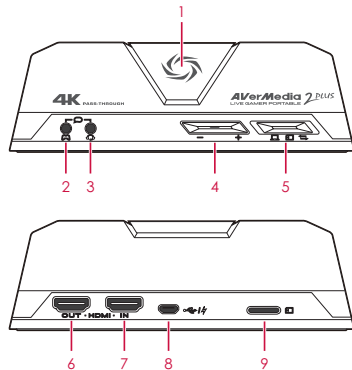

▼ INSTALACJA

Przód

Podłącz słuchawki i kontroler gier do portów audio, aby rejestrować własny komentarz i rozmowy.

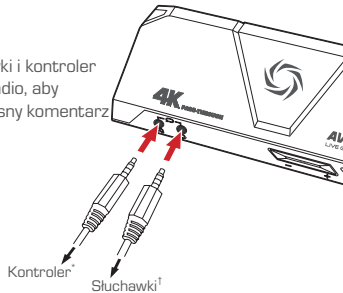

* Zalecane przez PS4 i Xbox One.

† Zalecane standardowe słuchawki do gier.

Tył

Podłącz urządzenia z tyłu LGP2+ w pokazany sposób.

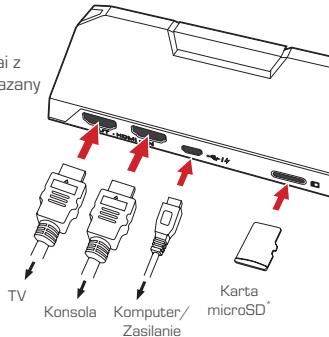

* Nie w komplecie.

▼ DZIAŁANIE

Przycisk RECcentral

Naciśnij raz, aby zacząć nagrywanie lub strumieniowanie, naciśnij ponownie, aby zatrzymać. Tę funkcję można skonfigurować w RECcentral.



Dioda LED wskazuje stan LGP2+:

Stale włączona



Gotowe

Zmienia natężenie



Strumieniowanie

Miga



Zajęte



Błąd*



Nagrywanie



Dysk pełny

Przełącznik trybu

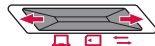

Przełącz przelącznik, aby zmienić tryb LGP2+.



Tryb PC: strumieniowanie i nagrywanie na PC



Tryb bez: nagrywanie na karcie microSD



Tryb pamięci: dostęp do karty microSD z komputera

Audio Buttons



Naciśnij — lub + aby dostosować głośność mikrofonu.

— (wł.): wyciszony

+ (miga 2x): osiągnięto limit

Naciśnij i przytrzymaj dowolny przycisk, aby przełączyć się między dwoma trybami.

+ (wł.): Tryb przelotowy

— (miga): Tryb monitora*

* Sprawdź sygnał, połączenie sieciowe, rozdzielczość, pamięć wewnętrzną lub kartę microSD.

* Tryb monitora służy do sprawdzania głośności wyjściowej.

HAZIRLIK

Kutunun İinde

Bu paraların tamamının paket iinde olduėunu kontrol edin.



Live Gamer Portable 2 Plus



HDMI Kablosu



USB Kablosu



4 Kutuplu 3.5 mm Ses Kablosu



Hızlı Kılavuz

RECentral

RECentral, Live Gamer Portable 2 Plus iin tasarlanmıř bir akıř/kayıt yazılımıdır.

řuradan indirin:

q.avermedia.com/gc513-recentral

Parçalar ve Bağlantı Noktaları

1	RECentral Düğmesi + LED
2	4 Kutuplu 3.5 mm Bağlayıcı (Denetleyici)
3	4 Kutuplu 3.5 mm Bağlayıcı (Kulaklık)
4	Ses Düğmeleri + LED
5	Mod Anahtarı
6	HDMI Çıkış
7	HDMI Girişi
8	Mikro-USB Bağlantı Noktası
9	microSD Kart Yuvası

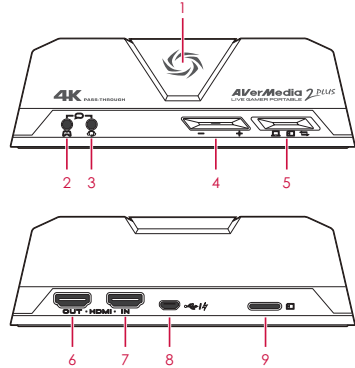

▼ KURULUM

Ön

Hem anlatım hem de parti sohbetinizi yakalamak için kulaklığınızı ve oyun denetleyicinizi ses bağlantı noktalarınıza bağlayın.

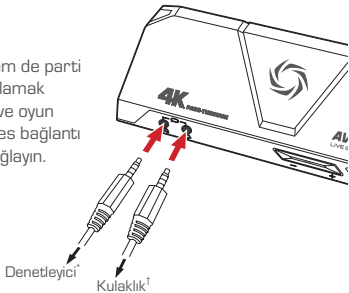

* PS4 ve Xbox One Önerilir.

† Standart oyun kulaklığı önerilir.

Arka

Aygitlarınızı gösterildiği şekilde LGP2+'nin arkasına bağlayın.

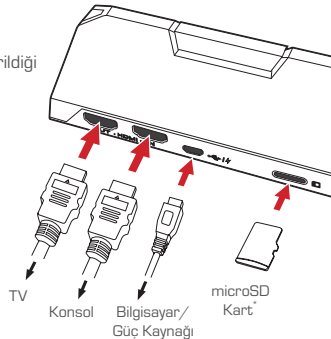

* Dahil değil.

▼ ÇALIŞTIRMA

RECentral Düğmesi

Kayıt veya akış için bir defa basın ve durdurmak için yeniden basın. Bunları RECcentral'te yapılandırabilirsiniz.

LED, LGP2+'nin durumunu gösterir:

Sürekli Açık



Hazır

Nefes alıyor



Akış yapıyor

Yanıp sönüyor



Meşgul



Hata*



Kaydediyor



Disk Dolu



Mod Anahtarı



Üç mod arasında LGP2+'yi kullanmak için anahtarı değiştirin.



PC Modu: Bilgisayarda akış ve kayıt



Bilgisayarsız Mod: İşlem sırasında microSD karta kaydedin



Saklama Modu: microSD karta bilgisayardan erişin

Ses Düğmeleri

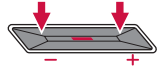

Basın — ya + da mikrofon ses düzeyini ayarlayın.

— (Açık): Sessiz

+ (İki Defa Yanıp Sönme): Sınıra Ulaşıldı

İki mod arasında geçiş yapmak için herhangi bir düğmeyi basılı tutun.

— (Açık): İçinden Geçilen

+ (Yanıp sönüyor): Monitör*

* Sinyalinizi, ağ bağlantınızı, çözünürlüğünüzü, depolamanızı ya da microSD kartınızı kontrol edin.

* Monitör Modunu çıkış sesinizin balansını kontrol etmek için kullanın.

▼ BEMUTATÁS

A doboz tartalma

Ellenőrizze, hogy minden kiegészítő megtalálható-e.



Live Gamer Portable 2 Plus



HDMI-kábel



USB-kábel



4-pólusú 3,5 mm
audiókábel



Telepítési
Útmutató

RECentral

A RECentral a Live Gamer Portable 2 Plus-höz kifejlesztett streaming/felvéví szoftver.

Töltse le innen:

q.avermedia.com/gc513-recentral

Részek és Csatlakozások

1	RECentral gomb + LED
2	4-pólusú 3,5 mm csatlakozó (vezérlő)
3	4-pólusú 3,5 mm csatlakozó (fejhallgató)
4	Audio gombok + LED
5	Üzem mód gomb
6	HDMI Kimenet
7	HDMI Bemenet
8	Micro-USB Port
9	microSD kártyafoglat

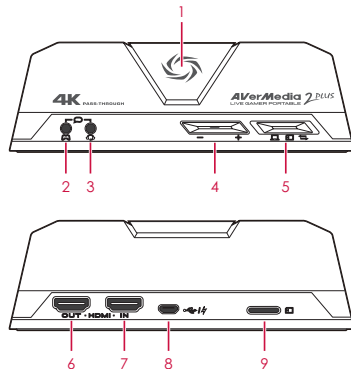

▼ BEÜZEMELÉS

Előlap

Csatlakoztassa a fejhallgatót és játékvezérlőt az audio portokhoz a megjegyzések és a csevegés rögzítéséhez.

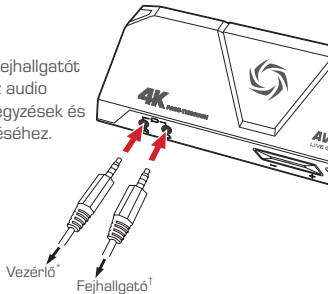

* PS4 és Xbox One rendszerek ajánlottak.

† Standard játékos fejhallgató ajánlott.

Hátlap

Csatlakoztassa az eszközöket az LGP2+ hátoldalába az ábrán látható módon.

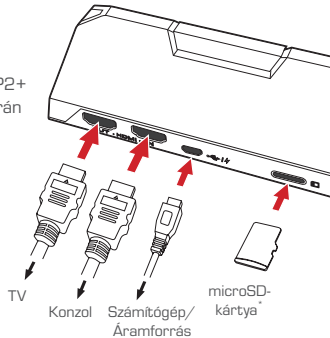

* Nem tartozék.

▼ HASZNÁLAT

RECcentral gomb

Nyomja meg egyszer a felvétel vagy streaming indításához, nyomja meg újra a leállításhoz. Ezeket konfigurálhatja a RECcentral-ban.



A LED lámpák az LGP2+ állapotát jelzik:

Világít	Lélegzés	Villog
Kész	Streaming	Foglalt
Hiba*	Rögzítés	Lemez megtelt

* Ellenőrizze a hálózati kapcsolatot vagy helyezzen be egy microSD kártyát.

Üzem mód gomb



Pöccintse meg a kapcsolót az LGP2+ átkapcsolásához a három üzemmód között.

- PC üzemmód: Streamelés és felvétel a számítógépen
- PC-mentes üzemmód: Felvétel microSD kártyára menet közben
- Tárolás üzemmód: microSD kártya elérése a számítógépről

Audio gombok



A mikrofon hangerejének beállításához nyomja meg a **-** vagy a **+** gombot.

(Be): Némítva

(Kétszer villog): Korlát elérve

A két üzemmód közötti váltáshoz tartsa lenyomva valamelyik gombot.

(Be): Pass-Through

(Villog): Monitor*

* Használja a Monitor üzemmódot a kiemeneti hangerő kiegyensúlyozásához.

▼ Подготовка

Комплектация

Проверьте наличие всех указанных позиций.



Live Gamer Portable 2 Plus



HDMI кабель



USB кабель



4-полюсный аудио
кабель 3,5 мм



Краткое
руководство

RECentral

RECentral - программное обеспечение с функциями потоковой передачи и записи, предназначенное для устройства видеозахвата Live Gamer Portable 2 Plus.

Ссылка для загрузки:

q.avermedia.com/gc513-recentral

Комплектация и порты

1	Кнопка RECentral + светодиод
2	4-полюсный разъем 3,5 мм (контроллер)
3	4-полюсный разъем 3,5 мм (гарнитура)
4	Аудиокнопки + светодиод
5	Переключатель режимов
6	HDMI Выход
7	HDMI Вход
8	Порт Micro-USB
9	Слот для карты microSD

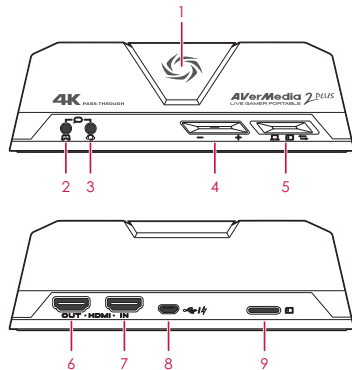

▼ Установка

Передняя панель

Подключите гарнитуру и игровой контроллер к аудиопортам, чтобы записывать как свои комментарии, так и чат болельщиков.



* Рекомендуется PS4 и Xbox One.

† Рекомендуется использовать стандартную игровую гарнитуру.

Задняя панель

Подключите ваши устройства к задней панели LGP2+, как показано на рисунке.

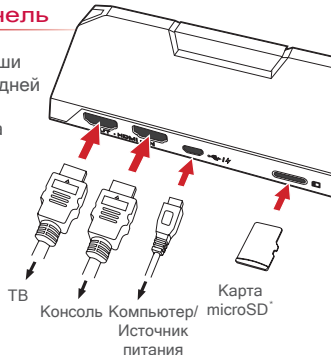

* В комплект не входит.







▼ Эксплуатация

Кнопка RECcentral

Нажмите один раз, чтобы начать запись или потоковую передачу, нажмите еще раз для остановки. Вы можете настроить это в программе RECcentral.



Светодиод показывает состояние LGP2+:



Горит постоянно	Пulsирует	Мигает
 Готово	 Потоковая передача	 Занято
 Ошибка*	 Запись	 Диск полон

* Проверьте сигнал, подключение к сети, разрешение, место сохранения или карту microSD.

Переключатель режимов



Выберите переключателем один из трех режимов LGP2+.

-  Режим работы с ПК: потоковая передача и запись на ПК
-  Автономный режим: запись сразу на карту microSD
-  Режим хранилища: доступ к карте microSD с ПК

Аудиокнопки

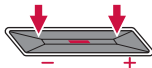

Нажмите — или + для регулировки громкости микрофона.
 (Горит): Без звука  (Мигает дважды): Достигнут предел

Нажмите и удерживайте любую кнопку для переключения между двумя режимами.

 (Горит): Сквозной  (Мигает): Монитора*

* Используйте режим монитора, чтобы проверить уровень выходной громкости.

▼ ΠΡΟΕΤΟΙΜΑΣΙΑ

Περιεχόμενο συσκευασίας

Ελέγξτε αν περιλαμβάνονται όλα αυτά τα αντικείμενα.



Live Gamer Portable 2 Plus



Καλώδιο HDMI



Καλώδιο USB



Καλώδιο ήχου
4 πόλων 3,5 mm



Οδηγός γρήγορης
εγκατάστασης

RECentral

Το RECentral είναι το λογισμικό ροής/εγγραφής που σχεδιάστηκε για το Live Gamer Portable 2 Plus.

Κατεβάστε το από:

g.avermedia.com/gc513-recentral

Εξαρτήματα και Θύρες

1	Κουμπί + LED RECentral
2	Φις 4 πόλων 3,5 mm (Ελεγκτής)
3	Φις 4 πόλων 3,5 mm (Ακουστικά)
4	Κουμπί + LED ηχού
5	Διακόπτης λειτουργίας
6	Έξοδος HDMI
7	Είσοδος HDMI
8	Θύρα micro-USB
9	Υποδοχή κάρτας microSD

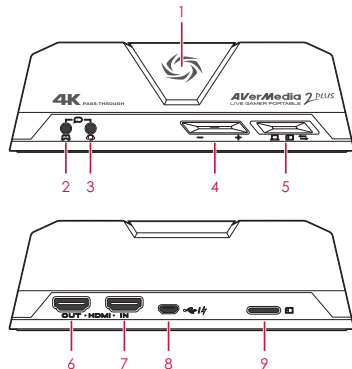

▼ ΕΓΚΑΤΑΣΤΑΣΗ

Μπροστά

Συνδέστε τα ακουστικά σας και τον ελεγκτή παιχνιδιών στις θύρες ήχου για καταγραφή σχολίων και συνομιλίας ομάδας σας.



* Συνιστάται PS4 και Xbox One.

† Συνιστώνται συνηθισμένα ακουστικά παιχνιδιών.

Πίσω

Συνδέστε τις συσκευές σας στο πίσω μέρος του LGP2+ όπως δείχνει η εικόνα.

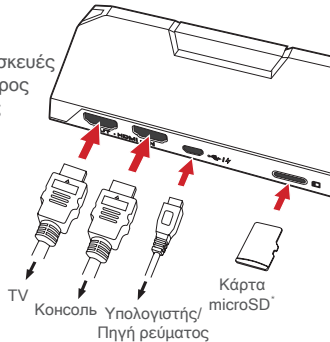

* Δεν περιλαμβάνεται.

▼ ΛΕΙΤΟΥΡΓΙΑ

Κουμπί RECentral

Πατήστε μία φορά για έναρξη εγγραφής ή ροής, πατήστε πάλι για διακοπή. Μπορείτε να κάνετε διαμόρφωση στο RECentral.



Το LED δείχνει την κατάσταση του LGP2+:

Συνεχώς σε λειτουργία



Έτοιμο

Αναπνοή



Ροή

Αναβοσβήνει



Απασχολημένο



Σφάλμα*



Εγγραφή



Δίσκος γεμάτος

* Ελέγξτε το σήμα σας, τη σύνδεση δικτύου, την ανάλυση, το μέσο αποθήκευσης ή την κάρτα microSD.

Διακόπτης λειτουργίας



Γυρίστε τον διακόπτη για να χρησιμοποιήσετε το LGP2+ σε τρεις λειτουργίες.



PC: Ροή και εγγραφή σε PC



PC-Ελεύθερη: Εγγραφή σε κάρτα microSD εν κινήσει



Αποθήκευσης: Πρόσβαση σε κάρτα microSD από το PC

Κουμιά ηχού



Πατήστε — ή + για ρύθμιση της έντασης μικροφώνου.

— (Σε λειτουργία): Σε σίγαση — (Αναβόσβησμα δύο φορές): Υπέρβαση ορίου

Κρατήστε πατημένο οποιοδήποτε από τα δύο κουμιά για να μεταβείτε από τη μία λειτουργία στην άλλη.

— (Σε λειτουργία): διέλευσης — (Αναβοσβήνει): οθόνης*

* Χρησιμοποιήστε Λειτουργία οθόνης για να ελέγξετε την ισορροπία της έντασης εξόδου σας.

▼ 준비

내용물

내용물이 모두 빠짐없이 있는지 확인합니다.



Live Gamer Portable 2 Plus



HDMI 케이블



USB 케이블



4 극 3.5mm
오디오 케이블



빠른 가이드

RECentral

RECentral 는 Live Gamer Portable 2 Plus 용으로 설계된 스트리밍/리코딩 소프트웨어입니다.

여기서 다운로드하세요:

q.avermedia.com/gc513-recentral

부속품 및 포트

1	RECentral 버튼 + LED
2	4극 3.5mm 커넥터 (컨트롤러)
3	4극 3.5mm 커넥터 (헤드셋)
4	오디오 버튼 + LED
5	모드 전환
6	HDMI 출력
7	HDMI 입력
8	마이크로 USB 포트
9	마이크로 SD 카드 슬롯

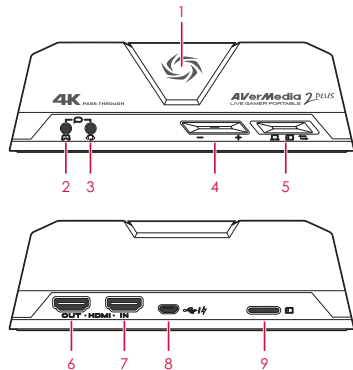

▼ 설치안내

전면

사용자의 해설 및 파티 채팅을 모두 캡처하기 위해서는 LGP2+ 전면 오디오 포트에 헤드셋과 게임 컨트롤러의 음성단자를 연결합니다.

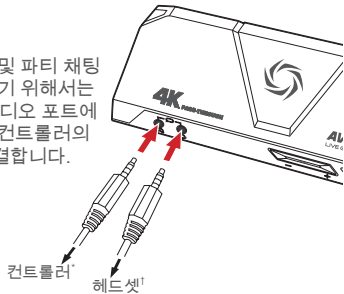

* PS4 와 Xbox One 사용 권장.

† 표준 게임용 헤드셋 권장.

뒤로

그림에 보이는 대로 장치를 LGP2+ 후면에 연결합니다.

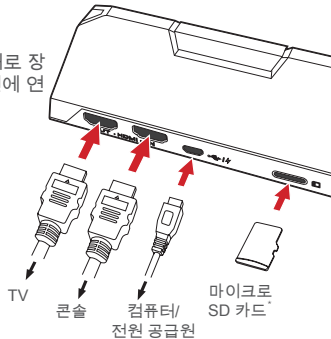

* 별매.

▼ 조작안내

RECentral 버튼

버튼을 한번 누르면 녹화 및 스트리밍을 시작합니다. 버튼을 다시 누르면 중지합니다. 상기 기능은 RECcentral 에서 설정할 수 있습니다.



LGP2+ 의 상태를 LED 표시등을 통해 확인할 수 있습니다:

계속 켜져있음



준비

천천히 점멸



스트리밍 중

빠르게 점멸



사용 중



에러*



녹화 중



저장공간 부족

* 사용자는 입력신호, 네트워크 연결, 해상도, 저장공간 또는 마이크로SD 카드를 확인해야 합니다.

모드 전환



스위치를 사용해 LGP2+ 의 세 가지 모드 사이를 전환합니다.



PC 모드: PC 에서 스트리밍하고 리코딩합니다.



PC 프리 모드: 이동 중에 마이크로 SD 카드에 리코딩합니다.



스토리지 모드: PC 에서 마이크로 SD 카드에 액세스합니다.

오디오 버튼



— 또는 + 를 눌러 마이크 음량을 조절합니다.

— (켜짐): 음소거

— (2 회 점멸): 한도 도달

두 가지 모드 사이를 전환하려면 두 개 버튼 중 하나를 길게 누르면 됩니다.

— (켜짐): 패스스루 모드

— (점멸): 모니터 모드*

* 모니터 모드는 출력 음량 밸런스 확인에 사용됩니다.

▼ 使用前准备

盒内配件

请确认盒内包含以下所有物品。



GC513 游戏直播盒



HDMI 传输线



USB 传输线



四段式 3.5 mm 音源线



快速安装手册

RECentral

RECentral 是专为 GC513 游戏直播盒打造的直播/录影软件。

由此下载：

q.avermedia.com/gc513-recentral

外观介绍

1	录制 & 直播按键 + LED
2	四段式 3.5 mm 插孔 (摇杆)
3	四段式 3.5 mm 插孔 (耳麦)
4	音量按键 + LED
5	模式切换开关
6	HDMI 输出
7	HDMI 输入
8	Micro-USB 插槽
9	microSD 卡插槽

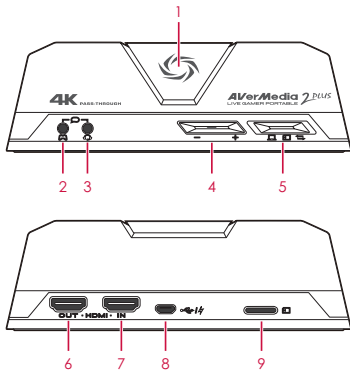

▼ 安装

正面

同时接上耳麦与游戏手柄或者摇杆即可将您的讲评与游戏团队聊天一并采集。

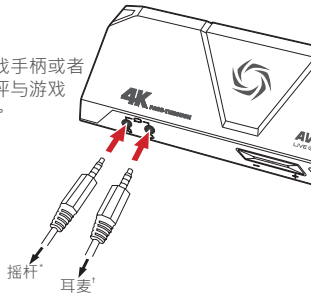

* 建议搭配 PS4 与 Xbox One 使用。

† 建议使用电竞专用耳麦。

背面

依照图片将您的装置连接到 GC513 的背面。

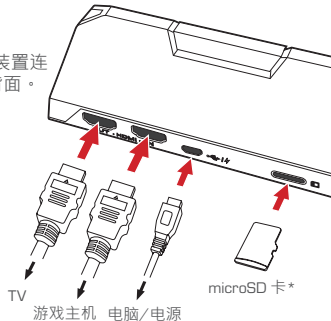

* 需另外购买。

▼ 操作

录制 & 直播按键

按一下开始录影/串流，再按一下停止。
您可于 RECentral 内自定义按键功能。



可由 LED 指示灯确认 GC513 直播盒的状态：

恒亮	呼吸	闪烁
就绪	直播中	忙碌
发生错误*	录影中	储存空间不足

模式切换开关



轻拨模式切换开关以切换 GC513 游戏直播盒的使用模式。

- PC 模式**：透过电脑直播或录影
- PC-Free 模式**：不透过电脑直接采集至 microSD 卡
- 读卡器模式**：透过电脑读取 microSD 卡上的数据资料

音量按键

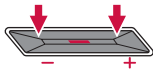

按 **-** 或 **+** 调整麦克风音量。

- (恒亮)：静音 **+** (闪两下)：已达最大声

按住任一音量按键以切换声音模式。

- (恒亮)：Pass-Through **+** (闪烁)：监听*

* 请检查您的信号装置、网络、分辨率、存储容量、或 microSD 卡。

* 使用监听模式确认声音平衡与输出音量。

▼ 使用前準備

盒內配件

請確認盒內包含以下所有物品。



LGP2+ 實況擷取盒



HDMI 傳輸線



USB 傳輸線



四段式 3.5 mm 音源線



快速安裝手冊

RECentral

RECentral 是專為 LGP2+ 實況擷取盒打造的串流/錄影軟體。

由此下載：

q.avermedia.com/gc513-recentral

外觀簡介

1	RECentral 按鍵 + LED
2	四段式 3.5 mm 插孔 (搖桿)
3	四段式 3.5 mm 插孔 (耳麥)
4	音量按鍵 + LED
5	模式切換開關
6	HDMI 輸出
7	HDMI 輸入
8	Micro-USB 插槽
9	microSD 卡插槽

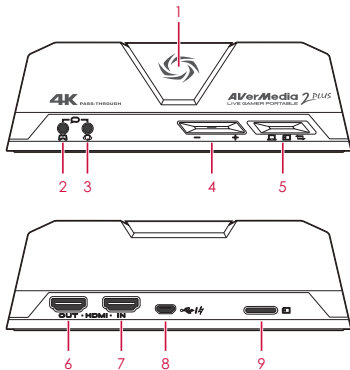

▼ 硬體連接

正面

接上耳麥與搖桿即可將您的講評與派對聊天一併擷取。

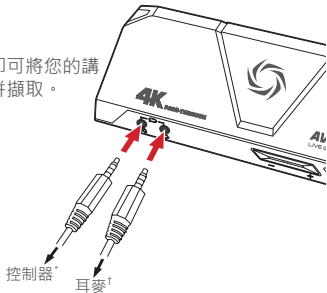

* 建議搭配 PS4 與 Xbox One 使用。

† 建議使用電競專用耳麥。

背面

依照圖片將您的裝置連接到 LGP2+ 實況擷取盒的背面。

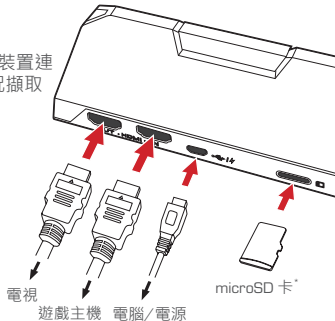

* 需另外購買。

▼ 操作

RECcentral 按鍵

按一下開始錄影/串流，再按一下停止。
您可於 RECcentral 內設定按鍵行為。





可由 LED 指示燈確認 LGP2+ 實況擷取盒的狀態：

恆亮	呼吸	閃爍
 就緒	 串流中	 忙碌
 發生錯誤*	 錄影中	 儲存空間不足

模式切換開關



以模式切換開關切換 LGP2+ 實況擷取盒的使用模式。

-  PC 模式：在電腦上直播或錄影
-  PC-Free 模式：不透過電腦直接擷取至 microSD 卡
-  讀卡機模式：透過電腦存取 microSD 卡資料

音量按鍵



按 **-** 或 **+** 調整麥克風音量。

-  (恆亮)：靜音
-  (閃兩下)：已達最大聲

按住任一音量按鍵以切換聲音模式。

-  (恆亮)：Pass-Through
-  (閃爍)：監聽*

* 請檢查您的訊號、網路、解析度、容量、或 microSD 卡。

* 使用監聽模式確認聲音平衡與輸出音量。

STREAM *2* VICTORY

www.avermedia.com