

# PC-DVD Encore 6x Dxr3 card

## User Guide

On-line Version

Information in this document is subject to change without notice and does not represent a commitment on the part of Creative Technology Ltd. No part of this document may be reproduced or transmitted in any form or by any means, electronic or mechanical, including photocopying and recording, for any purpose without the written permission of Creative Technology Ltd. The software described in this document is furnished under a license agreement and may be used or copied only in accordance with the terms of the license agreement. It is against the law to copy the software on any other medium except as specifically allowed in the license agreement. The licensee may make one copy of the software for backup purposes.

Copyright © 1999 Creative Technology Ltd. All rights reserved.

Version 1.0 (March 1999)

Sound Blaster is a registered trademark and PC-DVD, Dxr, and DynamicXtended Resolution are trademarks of Creative Technology Ltd. in the United States and/or other countries.

Dolby and the double-D symbol are registered trademarks of Dolby Laboratories Licensing Corp. All specifications are subject to change without prior notice.

Microsoft, Windows, and the Windows Logo are registered trademarks of Microsoft Corporation in the United States and/or other countries.

All other products are trademarks or registered trademarks of their respective owners.

## Creative End-User Software License Agreement

### License

**PLEASE READ THIS DOCUMENT CAREFULLY BEFORE USING THE SOFTWARE. BY USING THE SOFTWARE, YOU ARE AGREEING TO BECOME BOUND BY THE TERMS OF THIS AGREEMENT. IF YOU DO NOT AGREE TO THE TERMS OF THE AGREEMENT, YOU MUST NOT USE THE SOFTWARE. PROMPTLY RETURN, WITHIN 15 DAYS, THE SOFTWARE, ALL RELATED DOCUMENTATION AND ACCOMPANYING ITEMS TO THE PLACE OF ACQUISITION FOR A FULL REFUND.**

This is a legal agreement between you and **Creative Technology Ltd.** and its subsidiaries ("Creative"). This Agreement states the terms and conditions upon which Creative offers to license the software sealed in the disk package together with all related documentation and accompanying items including, but not limited to, the executable programs, drivers, libraries and data files associated with such programs (collectively, the "Software").

**1. Grant of License**

The Software is licensed, not sold, to you for use only under the terms of this Agreement. You own the disk or other media on which the Software is originally or subsequently recorded or fixed; but, as between you and Creative (and, to the extent applicable, its licensors), Creative retains all title to and ownership of the Software and reserves all rights not expressly granted to you.

**2. For Use on a Single Computer**

The Software may be used by you only on a single computer with a single CPU. You may transfer the machine-readable portion of the Software from one computer to another computer, provided that (a) the Software (including any portion or copy thereof) is erased from the first computer and (b) there is no possibility that the Software will be used on more than one computer at a time.

**3. Stand-Alone Basis**

You may use the Software only on a stand-alone basis, such that the Software and the functions it provides are accessible only to persons who are physically present at the location of the computer on which the Software is loaded. You may not allow the Software or its functions to be accessed remotely, or transmit all or any portion of the Software through any network or communication line.

**4. One Archival Copy**

You may make one (1) archival copy of the machine-readable portion of the Software for backup purposes only in support of your use of the Software on a single computer, provided that you reproduce on the copy all copyright and other proprietary rights notices included on the originals of the Software.

**5. No Merger or Integration**

You may not merge any portion of the Software into, or integrate any portion of the Software with, any other program, except to the extent expressly permitted by the laws of the jurisdiction where you are located. Any portion of the Software merged into or integrated with another program, if any, will continue to be subject to the terms and conditions of this Agreement, and you must reproduce on the merged or integrated portion all copyright and other proprietary rights notices included in the originals of the Software.

**6. Network Version**

If you have purchased a "network" version of the Software, this Agreement applies to the installation of the Software on a single "file server". It may not be copied onto multiple systems. Each "node" connected to the "file server" must also have its own license of a "node copy" of the Software, which becomes a license only for that specific "node".

**7. Transfer of License**

You may transfer your license of the Software, provided that (a) you transfer all portions of the Software or copies thereof, (b) you do not retain any portion of the Software or any copy thereof, and (c) the transferee reads and agrees to be bound by the terms and conditions of this Agreement.

**8. Limitations on Using, Copying, and Modifying the Software**

Except to the extent expressly permitted by this Agreement or by the laws of the jurisdiction where you acquired the Software, you may not use, copy or modify the Software. Nor may you sub-license any of your rights under this Agreement.

**9. Decompiling, Disassembling, or Reverse Engineering**

You acknowledge that the Software contains trade secrets and other proprietary information of Creative and its licensors. Except to the extent expressly permitted by this Agreement or by the laws of the jurisdiction where you are located, you may not decompile, disassemble or otherwise reverse engineer the Software, or engage in any other activities to obtain underlying information that is not visible to the user in connection with normal use of the Software. In any event, you will notify Creative of any information derived from reverse engineering or such other activities, and the results thereof will constitute the confidential information of Creative that may be used only in connection with the Software.

## Termination

The license granted to you is effective until terminated. You may terminate it at any time by returning the Software (including any portions or copies thereof) to Creative. The license will also terminate automatically without any notice from Creative if you fail to comply with any term or condition of this Agreement. You agree upon such termination to return the Software (including any portions or copies thereof) to Creative. Upon termination, Creative may also enforce any rights provided by law. The provisions of this Agreement that protect the proprietary rights of Creative will continue in force after termination.

## Limited Warranty

Creative warrants, as the sole warranty, that the disks on which the Software is furnished will be free of defects, as set forth in the Warranty Card or printed manual included with the Software. No distributor, dealer or any other entity or person is authorized to expand or alter this warranty or any other provisions of this Agreement. Any representation, other than the warranties set forth in this Agreement, will not bind Creative.

Creative does not warrant that the functions contained in the Software will meet your requirements or that the operation of the Software will be uninterrupted or error-free. **EXCEPT AS STATED ABOVE IN THIS AGREEMENT, THE SOFTWARE IS PROVIDED AS-IS WITHOUT WARRANTY OF ANY KIND, EITHER EXPRESS OR IMPLIED, INCLUDING, BUT NOT LIMITED TO, ANY IMPLIED WARRANTIES OF MERCHANTABILITY AND FITNESS FOR A PARTICULAR PURPOSE.**

You assume full responsibility for the selection of the Software to achieve your intended results, and for the installation, use and results obtained from the Software. You also assume the entire risk as it applies to the quality and performance of the Software. Should the Software prove defective, you (and not Creative, or its distributors or dealers) assume the entire cost of all necessary servicing, repair or correction.

This warranty gives you specific legal rights, and you may also have other rights which vary from country/state to country/state. Some countries/states do not allow the exclusion of implied warranties, so the above exclusion may not apply to you. Creative disclaims all warranties of any kind if the Software was customized, repackaged or altered in any way by any third party other than Creative.

## Limitation of Remedies and Damages

THE ONLY REMEDY FOR BREACH OF WARRANTY WILL BE THAT SET FORTH IN THE WARRANTY CARD OR PRINTED MANUAL INCLUDED WITH THE SOFTWARE. IN NO EVENT WILL CREATIVE OR ITS LICENSORS BE LIABLE FOR ANY INDIRECT, INCIDENTAL, SPECIAL OR CONSEQUENTIAL DAMAGES OR FOR ANY LOST PROFITS, LOST SAVINGS, LOST REVENUES OR LOST DATA ARISING FROM OR RELATING TO THE SOFTWARE OR THIS AGREEMENT, EVEN IF CREATIVE OR ITS LICENSORS HAVE BEEN ADVISED OF THE POSSIBILITY OF SUCH DAMAGES. IN NO EVENT WILL CREATIVE'S LIABILITY OR DAMAGES TO YOU OR ANY OTHER PERSON EVER EXCEED THE AMOUNT PAID BY YOU TO USE THE SOFTWARE, REGARDLESS OF THE FORM OF THE CLAIM. Some countries/states do not allow the limitation or exclusion of liability for incidental or consequential damages, so the above limitation or exclusion may not apply to you.

## Product Returns

If you must ship the software to Creative or an authorized Creative distributor or dealer, you must prepay shipping and either insure the software or assume all risk of loss or damage in transit.

## U.S. Government Restricted Rights

All Software and related documentation are provided with restricted rights. Use, duplication or disclosure by the U.S. Government is subject to restrictions as set forth in subdivision (b)(3)(ii) of the Rights in Technical Data and Computer Software Clause at 252.227-7013. If you are sub-licensing or using the Software outside of the United States, you will comply with the applicable local laws of your country, U.S. export control law, and the English version of this Agreement.

## Contractor/Manufacturer

The Contractor/Manufacturer for the Software is:

**Creative Technology Ltd.  
Creative Resource  
31 International Business Park  
Singapore 609921**

## General

This Agreement is binding on you as well as your employees, employers, contractors and agents, and on any successors and assignees. Neither the Software nor any information derived therefrom may be exported except in accordance with the laws of the U.S. or other applicable provisions. This Agreement is governed by the laws of the State of California (except to the extent federal law governs copyrights and federally registered trademarks). This Agreement is the entire agreement between us and supersedes any other understandings or agreements, including, but not limited to, advertising, with respect to the Software. If any provision of this Agreement is deemed invalid or unenforceable by any country or government agency having jurisdiction, that particular provision will be deemed modified to the extent necessary to make the provision valid and enforceable, and the remaining provisions will remain in full force and effect. For questions concerning this Agreement, please contact Creative at the address stated above. For questions on product or technical matters, contact the Creative technical support center nearest you.

## Hardware Warranty

Creative Technology Ltd. ("Creative") warrants to the original end-user purchaser only that the hardware product will be free of defects in materials and workmanship for a period of one year from the date of purchase. The physical media (whether CD-ROM or diskettes) enclosed herein are also warranted to be free of defects in materials and workmanship for a period of 60 days from the date of purchase, or such other period as may be expressly required by applicable law ("Warranty Period").

Should there be a material or workmanship defect in the hardware product or accompanying item(s) during the Warranty Period, the end-user purchaser shall obtain a Return Merchandise Authorization (RMA) number from the nearest support center and be responsible for all efforts and costs incurred in transporting/mailing/shipping/insuring the defective hardware or item(s) to and from the support center. A copy of a dated proof of purchase (e.g., a store receipt) should be enclosed in the returned package, with the RMA number clearly indicated on the outside.

Creative's entire liability and your remedy will be, at Creative's sole discretion, the repair or replacement (with the same or similar model) of any hardware or accompanying item(s) not meeting the "Limited Warranty" explained above that is returned to Creative or an authorized distributor or dealer during the Warranty Period with a copy of your receipt.

To the maximum extent permitted by applicable law, Creative disclaims all other warranties, expressed or implied, including the warranties of merchantability or fitness for a particular purpose with respect to the use of this product and the program license granted herein. Creative also disclaims any warranty or obligation to support products for all operating environments - for example, by ensuring interoperability with future versions of operating systems or other future software or hardware. In no event shall Creative or its licensors be liable for any indirect, incidental, special or consequential damages or for any lost profits, lost savings, lost data, personal injury, and so on, arising from or relating to the use of this software or hardware product, even if Creative or its licensors have been advised of the possibility of such damages.

Specifically, this warranty does not cover failures of the product which result from accident, abuse, misuse (including but not limited to improper installation, or connection to incorrect voltages or power points), alterations (by persons other than Creative or its authorized repair agents), moisture, corrosive environments, shipping, high voltage surges, or abnormal working conditions (including but not limited to lightning and water damage) after purchase. In no event will Creative's liability or damages to you, or any other person, ever exceed the purchase price you paid for the product, regardless of the form of the claim.

This warranty does not cover normal wear and tear, or in the case of communications products, the use of the product outside the borders of the country intended for use (as indicated by local telecommunication approval stickers).

Note: This warranty gives you specific legal rights. You may have other rights which vary from country/state to country/state. Certain limitations in this warranty are not permitted by the jurisdiction of some countries/states, so some limitations here may not apply to you.

## **Declaration of Conformity**

According to the FCC96 208 and ET95-19 documents,

Name: ***Creative Labs Inc.***

Address: ***1901 McCarthy Boulevard  
Milpitas, CA. 95035  
United States  
Tel: (408) 428-6600***

declares under its sole responsibility that the product

Trade Name: ***Creative Labs***

Model Number: ***CT7240***

has been tested according to the FCC / CISPR22/85 requirements for Class B devices and found compliant with the following standards:

EMI/EMC: ANSI C63.4 1992, FCC Part 15 Subpart B

This device complies with part 15 of the FCC Rules.

Operation is subject to the following two conditions:

1. This device may not cause harmful interference, and
2. This device must accept any interference received, including interference that may cause undesirable operation.

Ce matériel est conforme à la section 15 des règles FCC.

Son Fonctionnement est soumis aux deux conditions suivantes:

1. Le matériel ne peut être source D'interférences et
2. Doit accepter toutes les interférences reques, Y compris celles pouvant provoquer un fonctionnement indésirable.

***Compliance Manager  
Creative Labs, Inc.  
1 February 1999***

# Contents

---

## Introduction

Before You Begin.....	xi
System Requirements .....	xi
Document Conventions .....	xii
Text.....	xii
Icons .....	xii

## 1 Getting Acquainted with PC-DVD Encore

PC-DVD Drive.....	1
Front Panel .....	1
Rear Panel .....	2
Dxr3 Decoder Card.....	3
Accessories.....	4

## 2 Installing PC-DVD Encore

Step 1: Learn the Windows 95 Version.....	5
Step 2: Insert the Dxr3 Decoder Card.....	6
Step 3: Install the Drive in Your Computer .....	7
Step 4: Connect PC-DVD to Your Computer.....	9
Secondary IDE Connector .....	9
Secondary IDE Connector with CD-ROM Drive .....	10
Primary IDE Connector with Hard Disk Drive.....	11
Step 5: Connect Other Devices to the Dxr3.....	12
Sample Configuration for a Theater-like Sound System.....	14

<b>3</b>	<b>Installing Software</b>	
	Windows 95.....	15
	Step 1: Install PC-DVD Encore Device Drivers .....	16
	Step 2: Install the PC-DVD Player Application.....	17
	Enabling DMA Transfer (Windows 95 OSR2) .....	17
	Windows 98.....	18
	Windows NT 4.0.....	18
<b>4</b>	<b>Using Creative PC-DVD Player</b>	
	Setting Color and Resolution .....	19
	Using PC-DVD Player .....	21
	Creative PC-DVD Player .....	22
	Status Display.....	24
	Setting the Video Configuration .....	24
	DVD Menu (Title).....	26
	Language Settings .....	26
<b>A</b>	<b>Technical Specifications</b>	
	PC-DVD Drive.....	27
	Dxr3 Decoder Card.....	28
<b>B</b>	<b>Regional Codes</b>	
<b>C</b>	<b>Troubleshooting</b>	
	Sound.....	31
	PC-DVD Drive.....	31
	Video.....	32
	DVD Playback .....	34
	DVD Title.....	34
	Upgrading Your Operating System with PC-DVD .....	34

# Introduction

---

Congratulations on your purchase of Creative PC-DVD™ Encore! This guide provides you with information on how to install and operate the PC-DVD Encore hardware and software.

## Before You Begin

The README file on the Creative PC-DVD Encore diskette contains information and changes that were not available at the time of printing. Read the file before you continue.

You may want to make a backup copy of the diskette before you begin. In addition, read the following:

- System Requirements
- Document Conventions

## System Requirements

Minimum system requirements for PC-DVD Encore are as follows:

- A Pentium® 166 MHz PC or compatible
- 16 MB RAM
- 10 MB available hard disk space
- SVGA graphics adapter PCI expansion slot for the Dxr3 decoder card
- Enhanced IDE connector on the motherboard or PCI interface card (bus mastering with DMA support recommended)
- Drive bay (half-height) for the Creative PC-DVD drive (drive rails may be required for some systems and are not included)
- Sound Blaster or 100-percent compatible Sound Blaster audio card (Sound Blaster Live! or Sound Blaster PCI 128 is highly recommended)
- Microsoft® Windows® 95, Windows 98, or Windows NT® 4.0

## Document Conventions

The following conventions help you locate and identify the information you need.

### Text



---

Text Element	Use
<b>bold</b>	Text that must be entered exactly as it appears.
<i>italic</i>	On the DOS command line, italic text represents information you are to provide, usually described in a list following the command. Also, word or phrase that is being defined; title of a book or manual.
UPPERCASE	Key name, directory name, file name, or acronym.

---

### Icons

---

Icon	Use
	Note.
	Warning.

---



# Getting Acquainted with PC-DVD Encore



**CAUTION:** Use of controls or adjustments, or performance of procedures other than those specified herein may result in hazardous radiation exposure. *Do not open the PC-DVD drive case.*

PC-DVD Encore represents a breakthrough in optical disc technology. A digital video disc (DVD) has a maximum data capacity more than twenty-five times that of an ordinary CD—a full length movie with digital audio can be placed on a single disc! The PC-DVD drive and the Dxr3 decoder card enable you to play full-motion video with multi-channel sound on your personal computer, or on your television.

PC-DVD Encore can play not only the latest DVD movies but also CD formats such as audio CDs, CD-ROM software, and CD-R.

## PC-DVD Drive

The basic controls for your PC-DVD drive are on the front panel; the connectors for attaching the power, data, and audio cables are located on the rear panel.

### Front Panel



The appearance of your PC-DVD drive's front panel may differ from the figure shown.

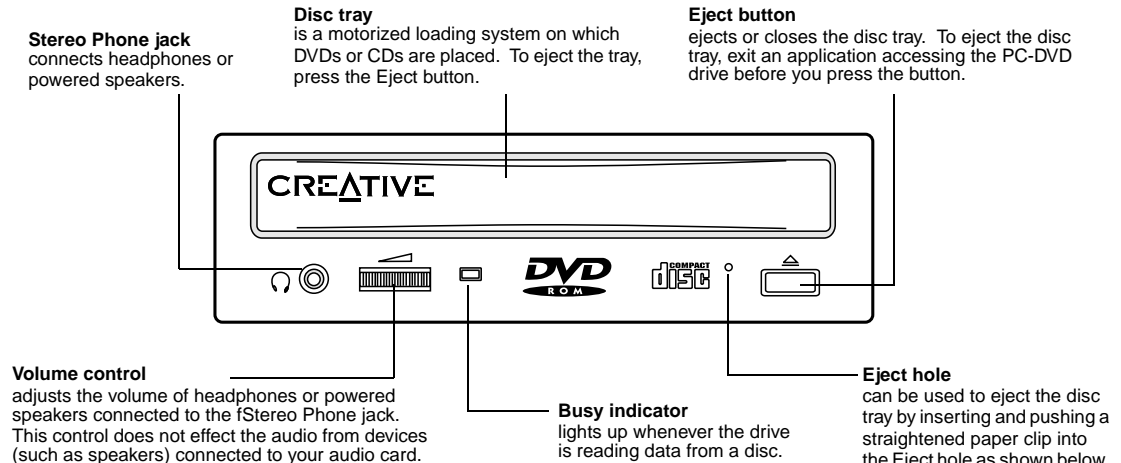



Turn off the power to your computer before inserting the paper clip into the Eject hole.

To open the disc tray manually:

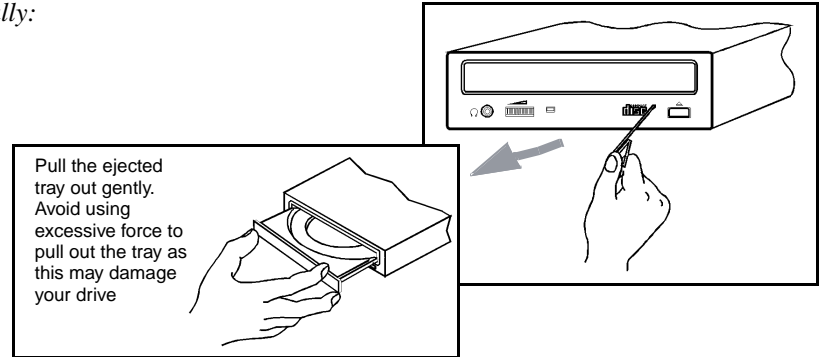

## Rear Panel

### CD Audio connector

sends audio from the PC-DVD drive through the Dxr3 card to the audio card when connected by a CD audio cable.

### Enhanced IDE Data connector

transfers data between the PC-DVD drive and devices, such as your computer's hard disk and motherboard, when connected by an IDE data cable.

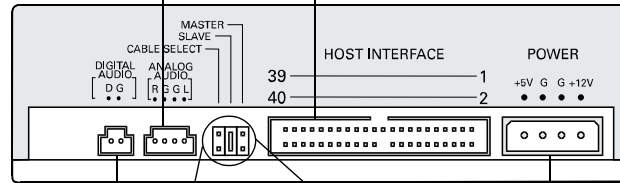

### Digital Audio connector

connects to a digital audio tape (DAT) or professional audio system for digital recording.

**Note:** This connector follows the EBU-IEC958 standard set by the European Broadcast Union (EBU).

### Power In connector

connects an electrical power cable from your PC power supply to the drive.

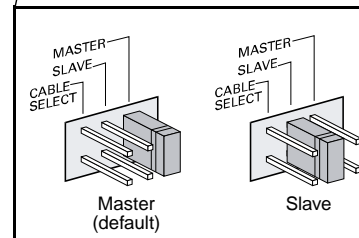

### Master/Slave jumper

sets the PC-DVD drive as *master* or *slave* when you connect it to another PC-DVD or CD-ROM drive.

**Note:** Cable Select is reserved and must not be used.

# Dxr3 Decoder Card

The DynamicXtended Resolution, or Dxr3, decoder card allows you to playback MPEG-1, MPEG-2 and DVD Video playback at a resolution as high as 1600x1200 pixels at a refresh rate of 85 Hz and a frame rate of 30 frames per second.

Your Dxr3 decoder card has the jacks and connectors shown below.

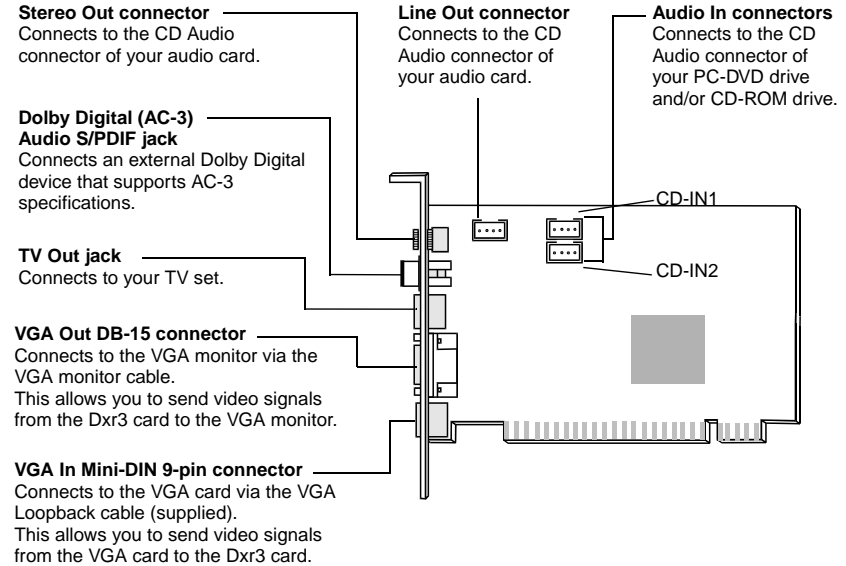

# Accessories

Your PC-DVD Encore 6x includes:

- CD Audio cable
- Dual Connector Audio cable
- VGA Loopback cable
- S-Video to Composite converter cable
- IDE Data cable.

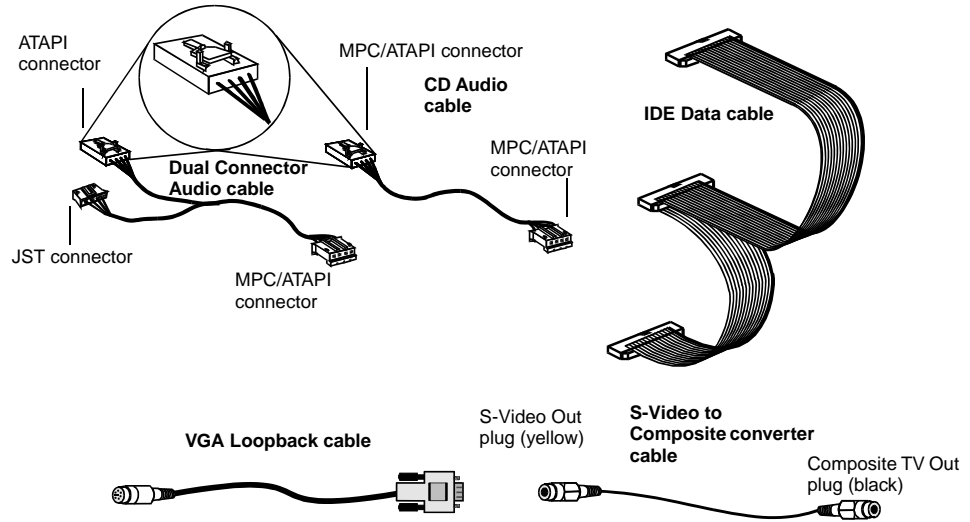

# Installing PC-DVD Encore

---

This chapter explains how to install and set up the PC-DVD drive and the Dxr3 decoder card in your computer:

- Step 1: Learn the Windows 95 Version
- Step 2: Insert the Dxr3 Decoder Card
- Step 3: Install the Drive in Your Computer
- Step 4: Connect PC-DVD to Your Computer
- Step 5: Connect Other Devices to the Dxr3

## Step 1: Learn the Windows 95 Version

How you install Creative PC-DVD Encore may be determined by your version of Windows 95. If you do not know your version number, follow this step to learn it. If you already know your version number, go to “Step 2: Insert the Dxr3 Decoder Card” on page 6.

*To obtain the Windows 95 version number:*

1. Click the Start button, point to Settings, and click Control Panel.
2. On the Control Panel, double-click the System icon.  
Your Windows 95 version number is displayed in the General tab page of the Systems Properties dialog.
3. Note the version number:
  - 4.00.950
  - 4.00.950A
  - 4.00.950B
4. Shut down Windows 95 and switch off the power.
5. Proceed to “Step 2: Insert the Dxr3 Decoder Card.”

## Step 2: Insert the Dxr3 Decoder Card



Use slot one or the available slot having the highest priority in your computer for best performance and compatibility. See your computer's manual for information on expansion slots and their priorities.



Do not force the Dxr3 decoder card into the slot. If it does not fit properly, remove it and try again.

The Dxr3 decoder card fits a PCI expansion slot.

*To install the Dxr3 decoder card:*

1. Turn off the power to your computer and any connected devices. Disconnect the power cord from the electrical source.
2. Touch a metal surface on the computer to ground yourself and discharge any static electricity.
3. Remove the cover from the computer.
4. Locate a free PCI expansion slot for the Dxr3 decoder card. The relative length and position of the PCI expansion slots are shown in the figure to the right.
5. Remove the metal plate from the expansion slot.
6. Align the Dxr3 decoder card with the PCI slot and press it into the slot as shown. The card must sit firmly inside the PCI slot.
7. Secure the Dxr3 decoder card in the slot by replacing the screw removed with the slot cover.
8. Proceed to "Step 3: Install the Drive in Your Computer."

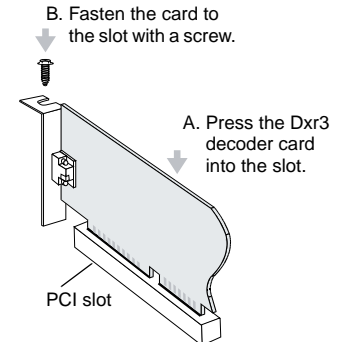
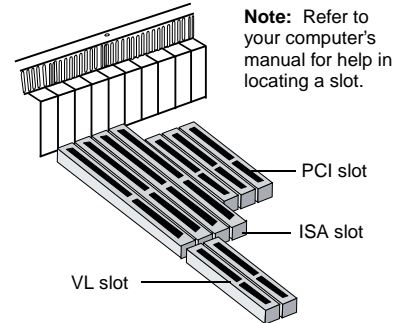

## Step 3: Install the Drive in Your Computer



You may want to connect the cables as described below before you insert the drive into the bay. Then, feed the cables through the bay as you insert the drive.



Set the Master/Slave jumpers to Master as shown in the figure on page 2, *unless* you know that you will be connecting to the Primary IDE connector with the hard disk drive.

1. Insert the PC-DVD drive into the drive bay as shown.

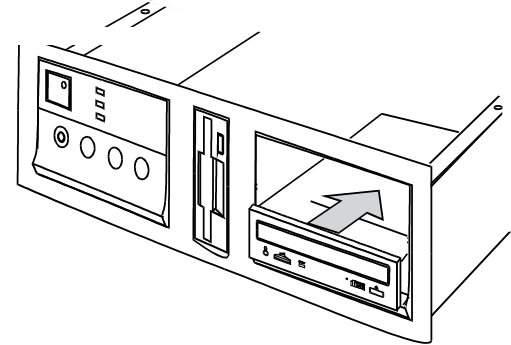

2. Connect a PC power cable to the PC-DVD drive. The computer's power supply is usually located in a rear corner; several power cables extend from the box with connectors available for internal devices.

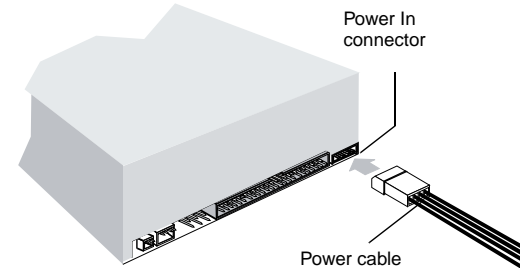



Be sure that you are connecting the correct end of the PC-DVD audio cable to the drive. See the figure on page 4 for a detail of the connector for the Dxr3 decoder card—use the other end for the PC-DVD drive.

3. Connect the IDE data cable to the PC-DVD drive.

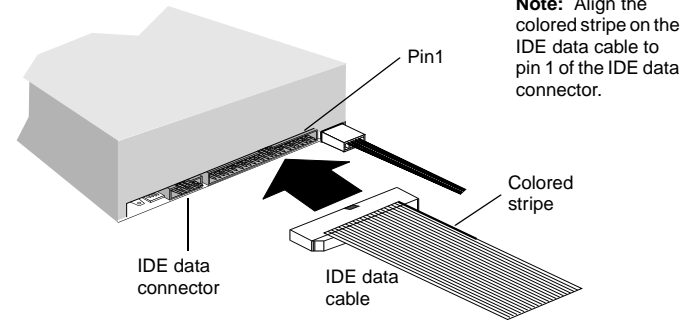

4. Connect the PC-DVD audio cable to the PC-DVD drive.

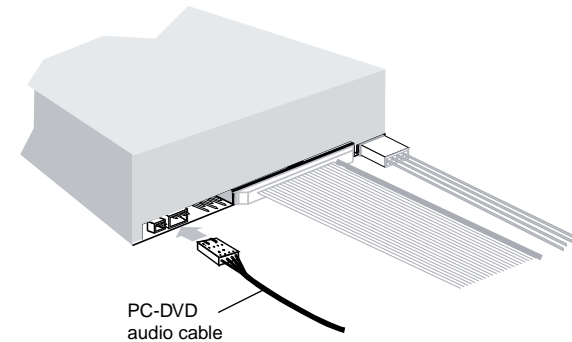



## Step 4: Connect PC-DVD to Your Computer

You can now connect the PC-DVD drive to the IDE controller on your computer's motherboard. The motherboard should have two IDE connectors: *Primary* is usually used by your hard disk drive; *secondary* is used by devices such as CD-ROM drives. Refer to your computer's documentation for the location of the IDE connectors.

Connect the PC-DVD drive to one of the following:

- Secondary IDE connector (recommended)**  
See "Secondary IDE Connector," below.
- Secondary IDE connector with CD-ROM drive**  
See "Secondary IDE Connector with CD-ROM Drive" on page 10.
- Primary IDE connector with hard disk drive**  
See "Primary IDE Connector with Hard Disk Drive" on page 11.

### Secondary IDE Connector

To connect the PC-DVD drive to the secondary IDE connector:

1. Set the PC-DVD drive as the *master* drive by placing the jumper block as shown.
2. Locate the secondary IDE connector on the motherboard.
3. Connect the IDE data cable to the secondary IDE connector, align the colored stripe on the cable to pin 1 of the IDE connector.
4. Connect the PC-DVD audio cable to the Dxr3 decoder card's Audio In connector (see "Dxr3 Decoder Card" on page 3).
5. Slide the drive back into place and use the screws provided to secure it to the computer. Proceed to "Step 5: Connect Other Devices to the Dxr3" on page 12.

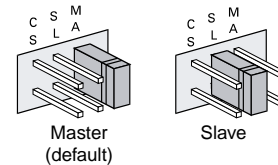

## Secondary IDE Connector with CD-ROM Drive



Daisy-chaining the PC-DVD drive with a CD-ROM drive may be used with Windows 95 OSR2 (version 4.00.950B) only—it is *not* recommended for other versions of Windows 95.

To connect to the secondary IDE connector with a CD-ROM drive:

1. Locate the secondary IDE connector on the motherboard.
2. Set the jumpers on the PC-DVD drive as *master* and the jumpers on the CD-ROM drive as *slave* (see the figure on page 2).
3. Connect the PC-DVD drive to the CD-ROM drive with the IDE data cable as shown below.
4. Connect your new PC-DVD drive to the secondary IDE connector using the IDE data cable as shown below.
5. Connect the PC-DVD audio cable to the Dxr3 decoder card's Audio In (CD\_IN1) connector, and the CD audio cable to the Dxr3 decoder card's Audio In (CD\_IN2) connector (see the figure page 3 for location of the connectors).

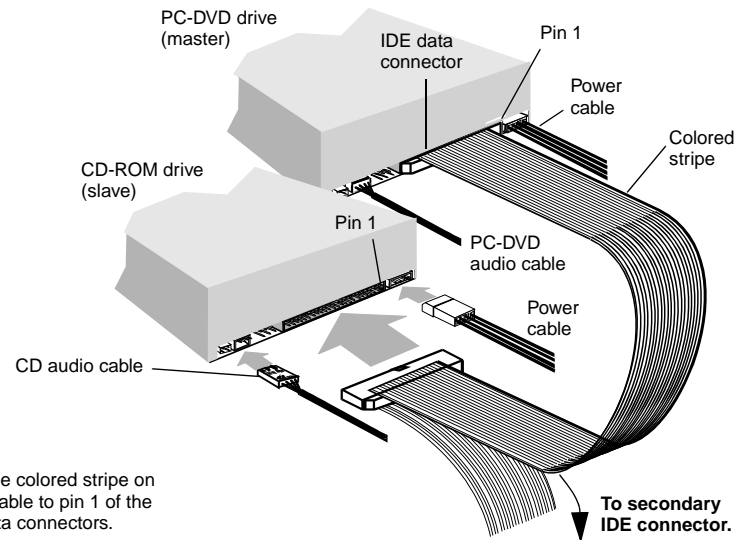

6. Slide the drives into place and secure them to the computer using the screws provided.
7. Proceed to “Step 5: Connect Other Devices to the Dxr3” on page 12.

## Primary IDE Connector with Hard Disk Drive

To connect the PC-DVD drive to the primary IDE connector with the hard disk:

1. Back up the files on your hard disk drive before you proceed.
2. Set the jumpers on the PC-DVD drive and the hard disk drive (see page 2). Set the hard disk drive to *master*; set the PC-DVD drive to *slave*.
3. Connect the power cable and IDE data cable to your hard disk drive.

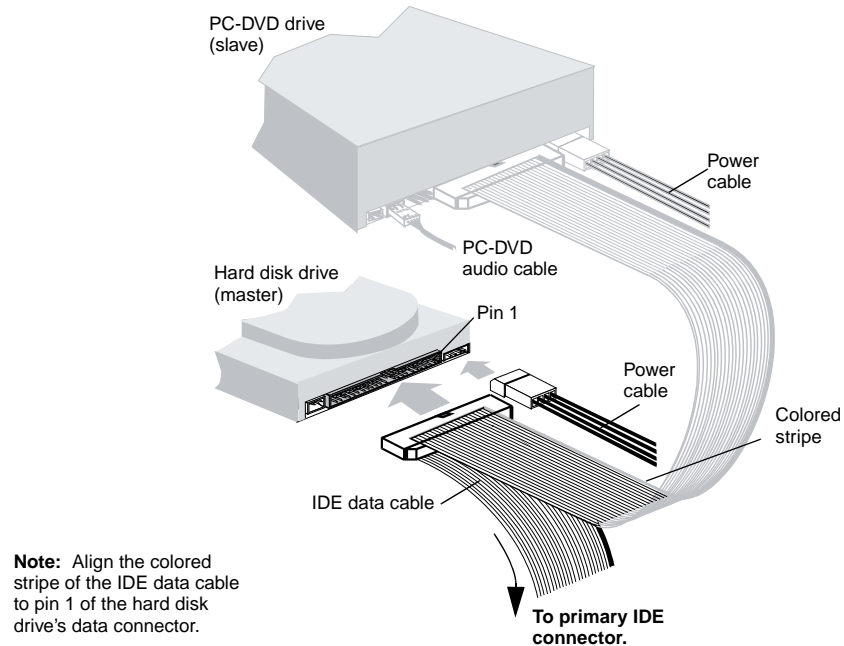

4. Connect the PC-DVD audio cable to the Dxr3 decoder card's CD\_IN1 connector (see figure on page 3).
5. Slide the drives back into place and secure them to the computer (screws are provided for the PC-DVD drive).
6. Proceed to "Step 5: Connect Other Devices to the Dxr3."

## Step 5: Connect Other Devices to the Dxr3

To connect devices to the Dxr3 decoder card:

1. If you have two CD Audio connectors on your audio card, follow the connections as shown in the figure.

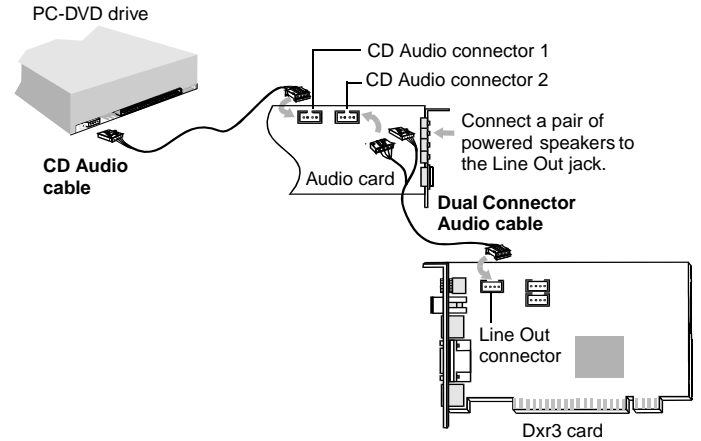

If you have one CD Audio connector on your audio card, follow the connections as shown.

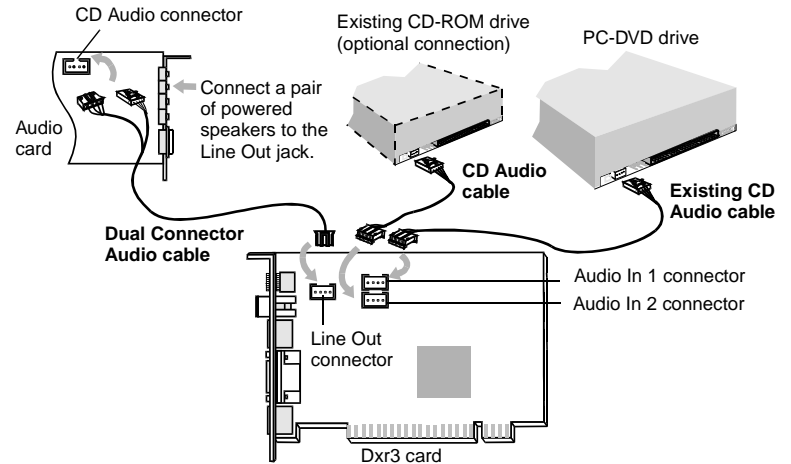

2. Disconnect the monitor from the VGA card and reconnect it to the bottom connector on the Dxr3 decoder card. Connect the VGA card and the Dxr3 decoder card using the VGA loopback cable provided.

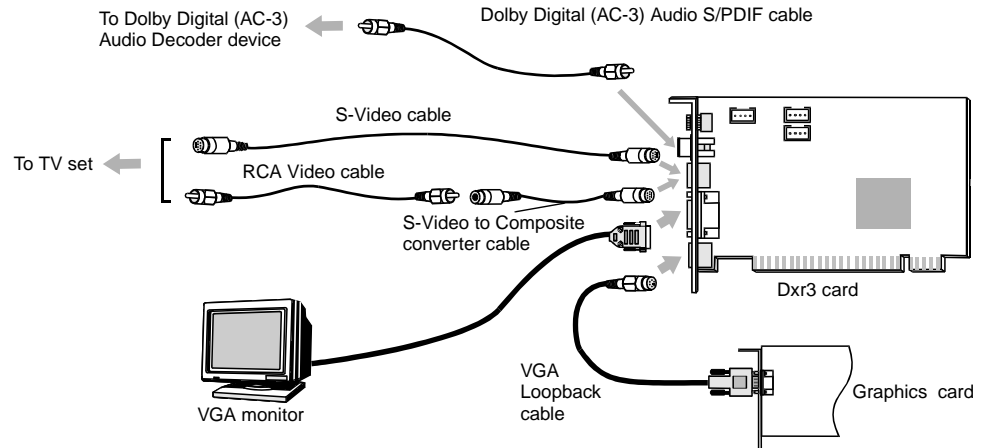

A Sound Blaster compatible audio card is required for connecting to the Dxr3 decoder card. To obtain the high-quality sound reproduction available with Dolby Digital, use a Sound Blaster PCI 128, or Sound Blaster Live! See the figure on page 14 for an example installation for theater-quality sound reproduction.



S-Video and RCA video cables are available separately.

To play DVDs on your television monitor, use the TV Out cable to connect the television to the Dxr3 decoder card's TV Out connector.

To play digital sound from a DVD or CD, connect a Dolby Digital receiver or amplifier to the Dxr3 decoder card using a high-quality RCA cable.

3. Replace the computer cover and reconnect the power cord.

## Sample Configuration for a Theater-like Sound System

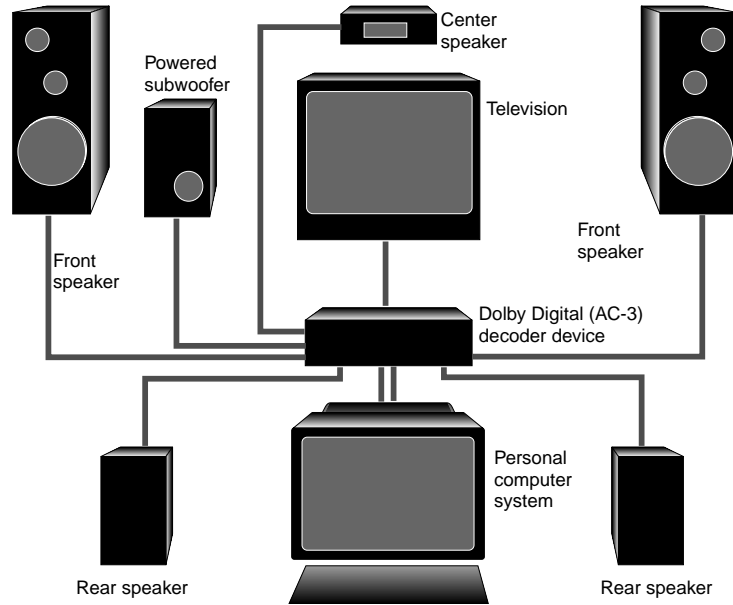

# Installing Software

---

After you install your PC-DVD drive and Dxr3 decoder card, you may install the PC-DVD software.

PC-DVD Encore includes a diskette containing the driver that controls the PC-DVD drive and Dxr3 decoder card, and a CD-ROM containing the DVD application “Creative PC-DVD Player.”

To install the DVD software, you need to:

- Step 1: Install PC-DVD Encore Device Drivers
- Step 2: Install the PC-DVD Player Application

## Windows 95

When you restart your computer to install the software, Windows 95 should automatically detect the PC-DVD drive and the Dxr3 decoder card.

If you need to install the driver and software manually, click the Start button on the Windows 95 Taskbar, select Settings, and click on Control Panel. On the Control Panel, double click on the Add New Hardware icon and follow the on-screen instructions. See your Windows 95 manual for more information.



The instructions that follow show the installation in Windows 95 and Windows 95 OSR2. If you are not sure which version you have, see “Step 1: Learn the Windows 95 Version” on page 5.

## Step 1: Install PC-DVD Encore Device Drivers

*For Windows 95 version 4.00.950 and 4.00.950A:*

1. Restart your computer. When Windows 95 starts, new hardware installed in your computer is automatically detected and the New Hardware Found dialog is displayed. Follow the instructions on screen.
2. Insert the PC-DVD Encore installation diskette into floppy disk drive A or B.
3. Select “Driver from disk provided by the hardware manufacturer” and click OK.
4. In the Install From Disk dialog, type **A:\** (or **B:\**) and click the OK button to copy the driver to the hard disk.
5. Follow the instructions on the screen to complete the installation.
6. Windows may prompt you to restart your computer, remove the diskette from the floppy disk drive and click the Yes button. If the prompt does not appear, remove the diskette from the disk drive and restart your computer.
7. Proceed to “Step 2: Install the PC-DVD Player Application.”

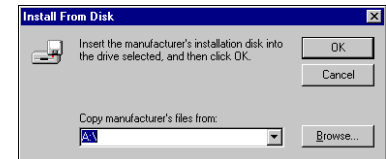

*For Windows 95 version 4.00.950B (OSR2):*

1. Restart your computer. When Windows 95 starts, it automatically detects the new hardware installed in your computer.
2. Insert the Creative PC-DVD Encore diskette into your floppy disk drive and click Next.
3. When Windows 95 prompts you for the device driver, click the Finish button.
4. On the Insert Disk dialog, click the OK button.
5. On the Copying Files dialog, type **A:\** (**A:\** or **B:\** is your floppy disk drive) and click the OK button to copy the device drivers to your hard disk.
6. When Windows prompts you to restart your system, remove the diskette from the floppy disk drive, select the Yes option, and click the OK button.
7. Proceed to “Step 2: Install the PC-DVD Player Application.”



## Step 2: Install the PC-DVD Player Application

The PC-DVD Player installation gives you three options:

- Typical
- Compact
- Custom

When the PC-DVD Player application is installed using *Typical*, a program group is created in Windows 95 that includes:

- PC-DVD Player
- PC-DVD Help
- Readme

*Compact* installation reduces the hard disk space required by not installing some files, such as the Help files; *Custom* installation allows you to select the components you want to install.

*To install Creative PC-DVD Player:*

1. Insert the PC-DVD Encore CD into your PC-DVD drive.  
If the setup program does not run automatically, follow numbers 2 and 3, below. If the setup program does run automatically, go to number 4, below.
2. Click the Start button and click Run.
3. In the Run dialog, type **D:\WINDOWS\SETUP** (D is your PC-DVD drive) and click OK.
4. Follow the instructions on screen to complete the installation.
5. Once the application is installed, remove the application CD from the PC-DVD drive and proceed to the next chapter Chapter 4, “Using Creative PC-DVD Player”.

## Enabling DMA Transfer (Windows 95 OSR2)

Enabling DMA transfer improves the smoothness of the video display.

*To enable DMA transfer:*

1. Click the Start button on the Windows 95 Taskbar, select Settings, and click Control Panel.
2. On the Control Panel, double-click the System icon.
3. On the System Properties page, click the Device Manager tab.
4. On the Device Manager tab page, double-click CDROM, then select Creative DVD-ROM.
5. Click the Properties button.
6. On the DVD-ROM drive’s properties dialog, click the Settings tab.
7. In the Options group, select the DMA check box.

## Windows 98

The following instructions describe the installation of the PC-DVD drivers and software in Windows 98.

*To install in Windows 98:*

1. The Windows 98 Add New Hardware Wizard automatically detects the Dxr3 decoder card and attempts to locate the driver media provided by the manufacturer. Insert the PC-DVD Encore installation diskette and click the Next button.
2. Select the Search For The Best Driver For Your Device (Recommended) option and click the Next button.
3. Clear all check boxes and check only the Specify a Location check box. Type or click the Browse button and point to the driver path: **D:\WINDOWS** (**D:** represents your CD-ROM drive). Click the Next button.
4. Click the Next button to install the Windows 98 drivers.
5. Click the Finish button when the installation is complete.
6. Restart your computer for the changes to take effect.
7. After Windows 98 restarts, insert the PC-DVD Encore CD into your PC-DVD drive.
  - If the setup program does not run automatically, follow numbers 8 and 9 below.
  - If the setup program does run automatically, go to number 10 below.
8. Click the Start button and click Run.
9. In the Run dialog, type **D:\WINDOWS\SETUP** (**D:** is your PC-DVD drive) and click OK.
10. Follow the instructions on screen to complete the installation.
11. Once the application is installed, remove the application CD from the PC-DVD drive and proceed to Chapter 4, “Using Creative PC-DVD Player.”

## Windows NT 4.0

The following instructions describe the PC-DVD software installation in Windows NT 4.0.

*To install in Windows NT 4.0*

1. Click the Start button on the Taskbar, select Settings, and click on Control Panel.
2. On the Control Panel, double-click the Multimedia icon.
3. On the Audio Devices tab page, click the Add option, and choose the Unlisted or Updated Driver option. Click the OK button.
4. Insert the PC-DVD installation diskette and follow the instructions for each screen to complete the installation.

# Using Creative PC-DVD Player

Creative PC-DVD Player controls the playing of DVDs and CDs on your computer including video and audio configuration, and viewing constraints.

This chapter gives instructions for setting up PC-DVD Player and describes its functions.

## Setting Color and Resolution



PC-DVD Player prompts you to automatically configure the video alignment the first time it is run following installation, or after you change the settings for your monitor in Windows 95.

Before you use PC-DVD Player, set your monitor to display “High Color (16-bit)” graphics with a screen resolution of 800x600 (minimum of 640x480) pixels. PC-DVD Player works with less color depth (minimum of 256 colors) and lower resolutions, but the quality may be poor.

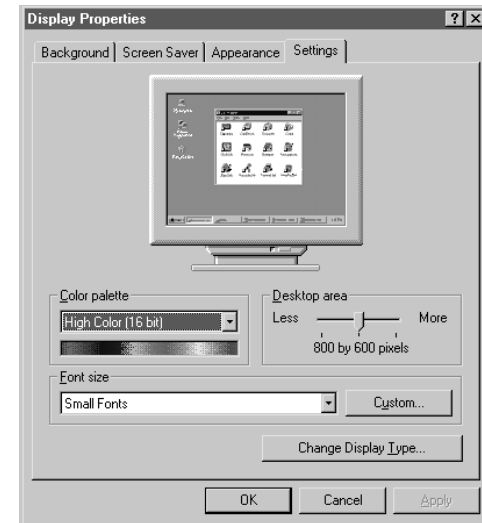



If you change the display color or screen resolution setting while PC-DVD Player is running, you must restart the application for the changes to take effect.

Also, some video cards have a utility for changing the color and resolution settings. The settings in the utility and in Windows 95 Display Properties Settings page should be the same. If the settings do not correspond, conflicts may occur. See the documentation for your video card for more information.

*To set your system color and resolution:*

1. Click the Start button on the Taskbar, select Settings, and click on Control Panel.
2. On the Windows Control Panel, double-click the Display icon.
3. On the Display Properties dialog, click the Settings tab.
4. From the Color Palette list, select “High Color (16-bit),” use the Desktop Area slider to set the resolution to 800x600 pixels, and click the OK button.
5. Windows displays a message that it is about to resize your desktop. When Windows reappears, you have 15 seconds to accept the settings; after 15 seconds, the old settings are restored. If the settings are correct, click the Yes button.

On some computers, you may have to restart your computer for the new settings to take effect.

Some video drivers and video card utilities allow you to change the refresh rate of your monitor. If you experience difficulties with the video when playing DVD titles, try changing the refresh rate to improve the quality, 60 Hz is recommended.



Run a movie DVD or movie file to align the video before running a game or other application from the PC-DVD drive.

## Using PC-DVD Player



The first time you start PC-DVD Player, you may be asked if you would like PC-DVD Player to automatically configure its video to conform to the current Windows 95 settings. The configuration process may *temporarily* corrupt the video.



When playing a title, you can switch between the framed display and full screen by double-clicking the left mouse button with the pointer in the viewing area. To return to the framed display, double-click the left mouse button.

Before you begin configuring PC-DVD Player, select the PC-DVD Readme icon and read the text for updated information that may not be included in this manual.

PC-DVD Player can be started in two ways:

- Place a DVD in the PC-DVD drive's disc tray and start your computer. If the DVD supports AutoPlay, Windows 95 automatically opens the PC-DVD Player and video display, and begins playing the title.
- With Windows 95 running, click on the Start button on the Taskbar, select Programs, select PC-DVD Encore, and click on PC-DVD Player. If there is no disc in the PC-DVD drive, you are notified that the tray is empty and the Player displays. If there is a disc in the tray, the Player and video display are opened, and the title begins playing automatically.

## Creative PC-DVD Player



You can switch between the three display modes by clicking the View button.



Details on PC-DVD Player features are available in the Help files. To display the Help files, click the right mouse button with the pointer in the PC-DVD viewing area, and click on Help on the menu.

PC-DVD Player interface is shown below.

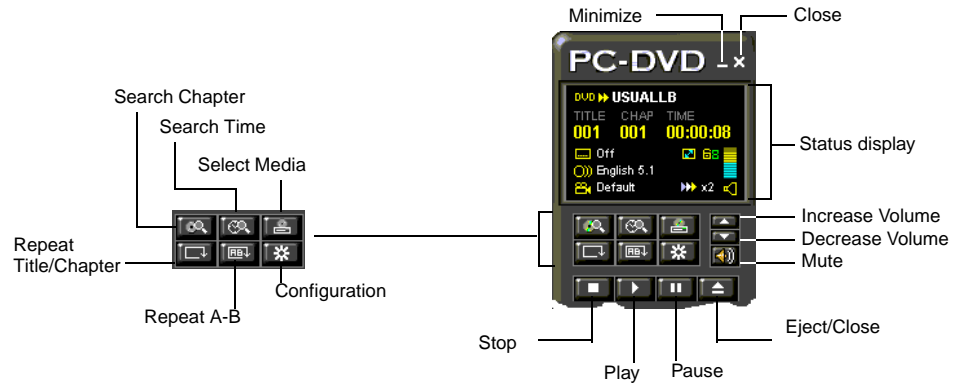

### Numeric Pad for Video CDs

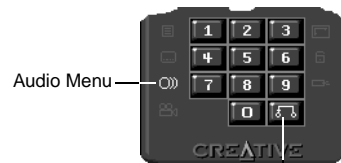

**Return button**  
Click this to return to the previous menu (if any).

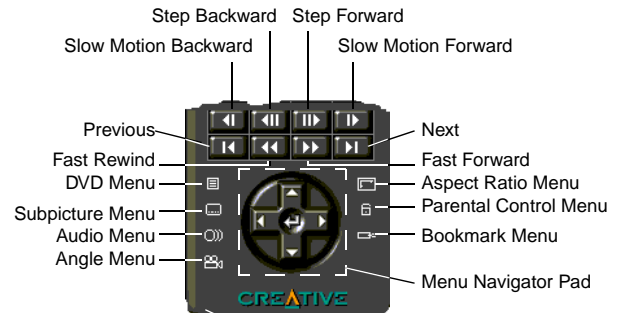

### Player

### Description



**Up arrow** moves the cursor up on DVD menus.

**Down arrow** moves the cursor down on DVD menus.















**Left arrow** moves down by page in DVD menu selections.

**Right arrow** moves up by page in DVD menu selections.

**Center arrow** opens selected DVD menu item.



Displays a list of chapters in a DVD title.

Player	Description
	Opens the Search menu for selecting a point of time within the title.
	Select Media displays a menu of available drive and directory locations. You can use the Play File dialog to select and search for viewable files.
	Repeats the current chapter (or the complete title). Click button to enable/disable repeat.
	Marks a segment on the disc that is to be repeated. Press once at the beginning of the segment; press a second time at the end of the segment. The segment repeats until settings are cleared by pushing the button again.
	Opens the PC-DVD Player settings menu with items for Video and Advanced Configuration, and Language. See “Setting the Video Configuration” on page 24.
	Volume control; click on the <b>up arrow</b> to increase volume or on the <b>down arrow</b> to decrease the volume.
	To mute sound, click on the speaker symbol below the volume arrows. When sound is muted, the  symbol appears over the speaker symbol in the Status Display.
	Opens the DVD menu on the disc. See “DVD Menu (Title)” on page 4-26.
	Subpicture menu displays a list of languages available for captions.
	Audio Menu
	Angle Menu; if no additional camera angles are available, the button is grayed out.
	Aspect Ratio menu offers choices for viewing if available on disc.
	Parental Control menu
	Bookmark menu; press the button to set a bookmark; when one or more bookmarks are set, a list of bookmarks is available for selection and organization.

## Status Display



The Status Display for Video CDs is slightly different than shown.

Information that relates to the current DVD title is given in the Status Display.

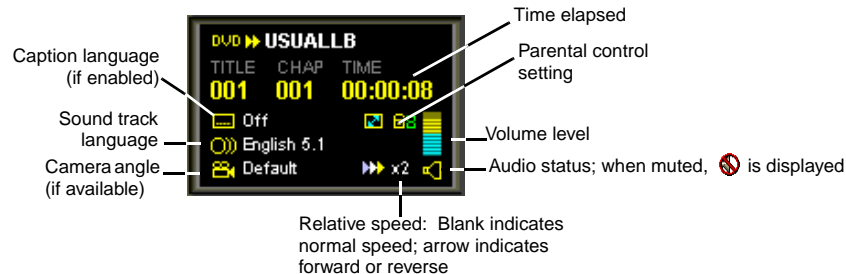

## Setting the Video Configuration

To set PC-DVD defaults:

1. Before setting the video configuration, pause or stop any disc that is currently playing. On the PC-DVD Player, click the Configuration button .
2. On the Configuration page, select the Video tab.
3. On the Video tab page, you can adjust:
  - Brightness (relative lightness/brightness):** Move the slider to the left to decrease; move the slider to the right to increase brightness.
  - Contrast (difference between dark and light colors):** Move the slider to the left to decrease; move the slider to the right to increase contrast.
  - Saturation (vividness of colors):** Move the slider to the left to decrease; move the slider to the right to increase saturation.
  - In the Video Output box, select the Format Type “Keep Output Same as Source”** if you TV supports the output format of the DVD-Video disc. If your TV supports only PAL and the TV video output is in a different format, select the Format Type “Forced to PAL.” If your TV supports only PAL and the TV video output is also PAL, select “Keep Output Same as Source.”

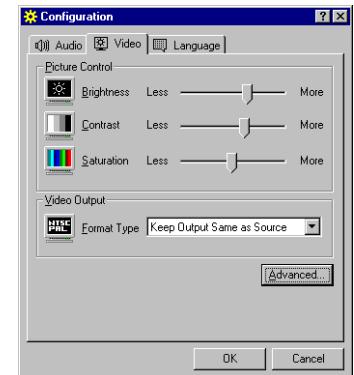

After adjusting the video, you may return to the previously saved settings by pressing Cancel.



4. Click on the Advanced button to display the Advanced Configuration dialog.
5. On the Advanced Configuration dialog, select the Alignment tab.
6. Click the Auto Align button, and then click the OK button. During the automatic configuration, your video display will be corrupted for up to 30 seconds.
7. If the automatic configuration is not successful, you may manually adjust the alignment:
  - a. On the Advanced Configuration dialog, clear the Color Key On check box. The overlay video is displayed on top of the VGA display.
  - b. To vertically align the video with the DVD Video window, move the Y-Offset slider.
  - c. To horizontally align the video with the DVD Video window, move the X-Offset slider and the Ratio slider. Continue to adjust the sliders until the blue line around the video is eliminated and the picture is aligned.
  - d. Enable Color Key On.
  - e. If traces of blue remain around the edges of the video display, move the Color Key 1 slider to reduce the blue lines. Move the Color Key 2 slider to the left to eliminate any traces of blue.
  - f. If the edges of the subtitles or captions appear jagged, adjust the In Delay slider.
  - g. If the video is now correct, press the OK button to save the settings and return to the Configuration page. You may return to the previously saved settings by pressing the Restore button.
8. On the Configuration page, click Advanced to open the Advanced Configuration page and select Video Adjustment.

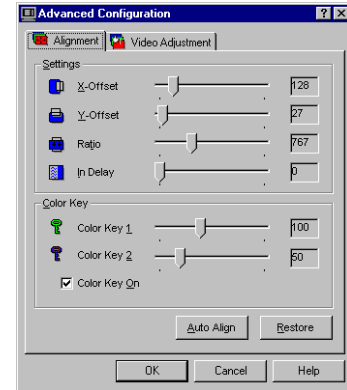

9. On the Video Adjustment page:

### Gain Control

- Increase/decrease the intensity of red, green, and blue in the video display by moving the slider left (decrease) or right (increase).
- Increase/decrease the combined colors by moving the Common Gain slider.
- When the color intensity is correct, click OK to save the settings and return to the Configuration dialog.  
To return to the previously saved settings, click the Restore button and click OK to exit Video Adjustment.

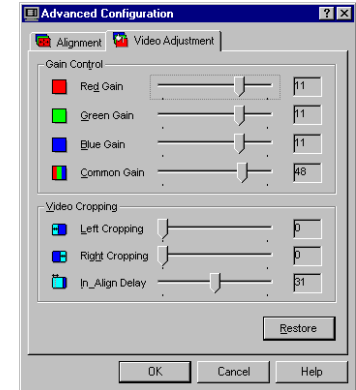

### Video Cropping

- To crop the left edge of your video display, move the Left Cropping slider to the right.
  - To crop the right edge of your video display, move the Right Cropping slider to the right.
  - If you experience distortion at the left or right edge of the video display, move the In\_Align Delay slider left/right until the distortion is eliminated.
10. Exit the Advanced Configuration page by clicking the OK button.

## DVD Menu (Title)

To display a DVD menu, click the  button on the PC-DVD Player. You must have a DVD in the PC-DVD drive to display a DVD menu—the menu displayed depends on the information encoded on the disc.

In general, a title menu includes such items as:

- List of scenes or chapters from which you can select and playback
- Cast: A list of the primary members of the cast, often with film biographies
- Trailer: The “Coming Attraction” theatrical teaser for the title
- Production Notes: A message from the title’s director or producer, usually about the making of the film and/or locations

## Language Settings

The Configuration page includes a Language tab page for setting the default language for audio, captions (subpicture), and menus. If the current disc supports the language choices on the Language tab page, they are used. If the language choices are not available, the default languages encoded on the disc are used.

Changes made to language choices during playback are used immediately. They do not take effect until you stop (or pause) and restart (resume) the playback.

# Technical Specifications

---

## PC-DVD Drive

### Average Access Time

DVD	180 msec
CD	120 msec

Buffer Memory 512 KB

### Data Capacity

DVD	One-sided/single layer: 4.7 GB
	One-sided/double layer: 8.5 GB
CD	748 MB (Mode 2)
	656 MB (Mode 1)

### Data Transfer Rate (Sequential)

DVD	8,100 KB/sec (6X)
CD	3,600 KB/sec max. (24X)

### Disc Formats Supported

- CD:
 

CD-Audio	CD-ROM	CD-ROM/XA
CD-I	CD-I Ready	CD-I Bridge
CD-R	CD-RW	Photo CD
Video CD	Enhanced Music CD	
- DVD:
 

DVD-R	DVD-ROM
-------	---------

# Dxr3 Decoder Card

## DynamicXtended Resolution

- Picture Enhancement Technology
- 6-tap filtering and scaling
- Advanced video color processor

## Connections

- RCA jack S/PDIF Out (5.1 channel Dolby Digital (AC-3)\* audio)
- JST audio output connector (downmix 5.1 channels to stereo)
- High density connector for:
  - S-Video output
  - Composite Video output
- DB-15 VGA Out
- DB-15 VGA In

## Video Playback

- DVD 1.0, MPEG-2 and MPEG-1
- 30 frames per second (NTSC)
- Supports Windows® resolution up to 1600x1200
- Analog video overlay function

## Audio Playback

- Dolby Digital (AC-3)\* ready, 5.1 channel (DVD) digital coded bit stream
- Linear PCM
- MPEG Audio (Video-CD)

## VGA Compatibility

- Support Windows® resolution up to 1600x1200, 85Hz refresh

---

\* Dolby Digital (AC-3) 5.1-channel audio requires an amplifier or receiver with Dolby Digital coaxial input, or Cambridge Soundworks® Desktop Theater™ 5.1 speaker system, and Dolby Digital-supported titles.

# Regional Codes

Regional codes are part of the DVD standard—your regional code (Region 1) is embedded in the DVD software. Regional codes on DVDs are optional. Discs without codes will play on any player or drive in any country.

There are six major DVD regions:

- Region 1: United States and Canada
- Region 2: Japan, Europe, Middle East, South Africa
- Region 3: Southeast Asia (including Hong Kong)
- Region 4: Australia, New Zealand, Central and South America
- Region 5: Northwest Asia, Africa (except South Africa)
- Region 6: China

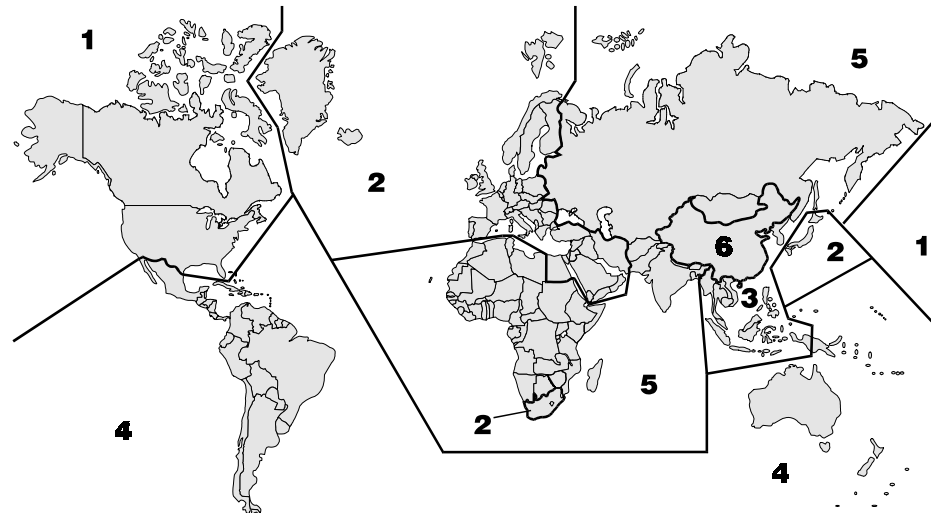



# Troubleshooting

---

This appendix helps solve problems that you may encounter while installing or using PC-DVD Encore.

## Sound

**PROBLEM** No sound from speakers.

**Cause** This may be caused by one of the following:

- The audio cable or speakers are not connected properly.
- The volume is not adjusted to an audible level.
- The drive may be faulty.

**Solution** Try one of the following:

- Ensure that the PC-DVD drive, Dxr3 decoder card, and audio card are connected as shown in the figures in “Step 5: Connect Other Devices to the Dxr3” on page 12. Also, ensure that the speakers are connected to the audio card’s Speaker Out jack.

Click the Start button on the Windows 95 Taskbar, select Programs, select Accessories, select Multimedia, and click on Media Player. Open the Device menu and click on CD Audio. Adjust the volume control slider, if necessary.

Or, if a speaker icon is displayed in the right end of the Windows 95 Taskbar, click the icon to display the volume control; make sure the Mute checkbox is clear and adjust the volume control slider as needed.

- Connect your headphones to the Stereo Phone jack on the front panel of the PC-DVD drive. If there is no sound from the headphones when an audio CD is playing in the PC-DVD drive, consult your dealer about the possibly faulty drive.

## PC-DVD Drive

**PROBLEM** On attempting to play a disc, the following message appears: “Disc does not contain DVD Video data”

**Cause** PC-DVD Player cannot find the title track and/or information files.

**Solution** Click on OK to close the message—the disc may be in standard CD-ROM format and may play.

<b>PROBLEM</b>	<b>Following hardware installation, the following message appears: “Unable to locate DVD-ROM drive assume drive D:. Error1”</b>
<b>Cause</b>	The PC-DVD drive may not have been configured by Windows 95 or may be disconnected.
<b>Solution</b>	<input type="checkbox"/> Check the cable connections. <input type="checkbox"/> Run the Windows 95 Add New Hardware wizard and allow Windows 95 to detect and install the PC-DVD drive.
<b>PROBLEM</b>	<b>The PC-DVD drive is not switched on when the system is restarted.</b>
<b>Cause</b>	The power cable is not connected.
<b>Solution</b>	Ensure that the power cable is connected to the drive.
<b>PROBLEM</b>	<b>PC-DVD drive is not detected.</b>
<b>Cause</b>	The IDE data cable is not connected correctly.
<b>Solution</b>	Ensure that the IDE data cable is connected properly to the drive and the computer.
<b>PROBLEM</b>	<b>Your computer does not recognize the PC-DVD drive.</b>
<b>Cause</b>	The driver for the PC-DVD drive or the Dxr3 decoder card is not installed properly.
<b>Solution</b>	Re-install the drivers using the installation diskette.
<b>PROBLEM</b>	<b>The disc tray cannot be ejected.</b>
<b>Cause</b>	<input type="checkbox"/> The eject command is not being transmitted to the PC-DVD drive by your computer. <input type="checkbox"/> An application that is currently running is preventing the eject command. <input type="checkbox"/> The IDE data cable is not connected correctly.
<b>Solution</b>	<input type="checkbox"/> Turn off the computer. If you have a disc in the disc tray, insert a straightened paper clip into the Eject hole on the drive’s front panel to eject the disc tray. Restart your computer. <input type="checkbox"/> Close the application that is running and restart your computer. <input type="checkbox"/> Check the IDE data cable connect between the PC-DVD drive and the computer.
<b>PROBLEM</b>	<b>When attempting to play a DVD, a message is displayed: “The Interactive DVD Browser requires ActiveMovie. ActiveMovie either is not installed or not functional.”</b>
<b>Cause</b>	ActiveMovie was either not installed or is being used by another application.
<b>Solution</b>	<input type="checkbox"/> Check the Taskbar to see if a multimedia application may be running. <input type="checkbox"/> Install ActiveMovie: Place the PC-DVD Encore installation CD in the PC-DVD drive; use Windows 95 Explorer to locate the AMOVIE.EXE file in the AMOVIE directory. Double-click to install the English-language version of ActiveMovie.

## Video



- PROBLEM** During video configuration the following message appears: “Auto Alignment failed.”
- Cause** The Dxr3 decoder card cable not be properly connected.
- Solution**
- Check the cable connections on the Dxr3 card, particularly, VGA IN and VGA out.
  - Start PC-DVD Player, press the Settings button, and select Video Configuration. Press the Auto button to have the video automatically configured.
- PROBLEM** The video displayed on the monitor is blue or partially blue.
- Cause**
- VGA loopback cable is not connected correctly.
  - Video alignment is not set correctly.
  - Colorkey value is not set correctly.
- Solution**
- Check the VGA loopback cable connection. Try reversing the cable connections.
  - Open the Video Configuration utility and set the video alignment. Use the Auto button to configure the video. If this does not work, try make minor adjustments manually.
  - Change the color combination of the Windows 95 desktop. Click the right mouse button on the Windows 95 desktop and click on Properties. On the Display Properties page, click on the Appearance tab. On the Appearance tab page, select Desktop in the Item list and select a different color from the list. Click on OK to make the change.
- PROBLEM** The video displayed on the monitor is not smooth.
- Cause**
- Bus mastering device driver is not installed.
  - CMOS settings for the PC-DVD drive are not correct.
  - DMA transfer is not enabled. (Windows 95 OSR2 only.)
- Solution**
- Obtain the bus master device driver from your computer manufacturer or dealer.
  - Do the following in CMOS:
    1. Restart your system.
    2. During the memory check, press the DELETE key to display the CMOS setup menu.
    3. Select Integrated Peripherals and press ENTER.
    4. Set your PC-DVD drive’s PIO to Mode 4. For example, if the PC-DVD drive is connected as *Slave* to the primary IDE, set IDE Primary Slave PIO to Mode 4.
    5. Press ESC to return to the CMOS setup menu.
    6. Select Save & Exit Setup and press ENTER.
    7. Press the Y key and then press ENTER.
  - Enable the DMA transfer. See “Enabling DMA Transfer (Windows 95 OSR2)” on page 17.



Changing settings in CMOS incorrectly can cause the system to stop functioning.



Some of the following steps may not apply to your computer’s CMOS. Refer to your computer’s CMOS documentation for details.

## DVD Playback

**PROBLEM** Error playing back .VOB files from DVD movie titles.  
**Cause** The .VOB files in DVD titles are protected by copyright.  
**Solution** Use Creative PC-DVD Player's Open File dialog to playback DVD titles.

**PROBLEM** Error playing back .MPG files.  
**Cause** The .MPG files may not conform to MPEG-1 or MPEG-2 format.

## DVD Title

**PROBLEM** If the DVD has a capacity greater than 4 GB, the size is not read correctly by Windows 95.  
**Cause** This is a limitation of Windows 95 drivers that was corrected in Windows 95 OSR2.  
**Solution** Microsoft has corrected the problem with Windows 95 OSR2 and within Windows 98. Creative is currently working on device drivers that will correct the situation; check our website for the availability of the drivers. DVDs still function properly with the PC-DVD drive.

## Upgrading Your Operating System with PC-DVD

To upgrade from DOS to Windows 95 using the PC-DVD drive (as a CD-ROM drive), install the DOS driver for your PC-DVD drive:

1. Switch on your computer.
2. Insert the Creative PC-DVD Encore installation diskette into your floppy disk drive.
3. At the DOS prompt, type **A:\INSTALL.EXE** (A:\ is your floppy disk drive).
4. Follow the instructions on the screen to enable the PC-DVD drive to be recognized as a CD-ROM drive.
5. Install Windows 95, then install the PC-DVD software.