

Proteus® VX

Proteus VX



Operation Manual



Operation Manual

© 2006-2007 E-MU Systems

All Rights Reserved

Software Version: 2.0.1 - PTSB4

E-MU World Headquarters

E-MU Systems

1500 Green Hills Road
Scotts Valley, CA 95066
USA

Asia Pacific, Africa, Middle East

Creative Technology Ltd

31 International Business Park
Creative Resource. Singapore 609921
SINGAPORE

Europe

Creative Labs

Ballycoolin Business Park
Blanchardstown
Dublin 15
IRELAND

E-MU Japan

Creative Media K K

Kanda Eight Bldg., 3F
4-6-7 Soto-Kanda
Chiyoda-ku, Tokyo 101-0021
JAPAN

Table of Contents

1 - Introduction & Installation 9

Introduction	9
Proteus VX	9
Before you Begin...	9
Notes, Tips and Warnings	10
System Requirements	10
Software Installation	10
Programs installed	10
Optimizing Your Computer for Proteus VX	11
Setting up Cubase LE4 and Proteus XVSTi	11
Running Proteus VX VSTi from Cubase LE4	13
On Your Own	16
Troubleshooting Checklist	17
No MIDI Keyboard Control?	17
No Audio?	17
Setting up the Preferences	18
Audio Preferences	19
Audio Setup	19
Use Optimal Buffer Size	19
Buffer Size	19
Sample Rate	19
CPU Cap	19
Headroom/Boost	20
Ultra-High Precision Interpolation Button	20
VST Output Buses	20
MIDI	20
MIDI Inputs	21
MIDI Response	21
Controllers	22
Other Settings	23
Appearance Settings in Windows	24
Proteus VX Question & Answer	25

2 - Guided Tours 27

Exploring the Tree	27
Multisetup Page	28
Changing Presets (from Single View)	29
Channel 1-16 View	30
Changing Presets (from the 1-16 view)	30
Adjusting the Controllers	31
Create Your Own Custom Bank	32
Save and Save As	33
Proteus VX Bank Structure	33
The Librarian	34

3 - Multisetup / Global Controls 37

The Multisetup	37
Changing Presets (from Single View)	38
16 Channel View	39
Saving your Multisetup	39
The Current MIDI Channel	40
MIDI Channel	40
Preset Assignment	40
Channel Volume	40
Channel Pan	40
Output Assignment	40
Output View Button	41
Aux FX View Buttons	41
Aux Send On/Off	41
Preset FX Enables	41
Select Effect	41
TwistaLoop Override	41
Global Controls	42
Master Volume Control & VU Meter	42
Tempo Control	42
Master Tune	42
Master Transpose	42
Limiter	42
Aux Outputs	43
Filter Override	44
Filter Descriptions	44
Filter Types	44
MIDI Controllers & Scribble Strips	46
Preroll RAM Used	46
CPU Meter	47
Number of Samples Playing	47
Current Channel	47
Working with Multisetups	48
Saving FX & Multisetups	48
VSTi Multisetups	48

4 - Preset Editor 51

Preset Globals	52
Transpose & Volume	52
Initial Controllers A-P	52
Capture MIDI Controllers	53
TwistaLoop Lock To Tempo	53
Initial Tempo	53
Tuning Tables	54
Preset Modulators	56
Templates	56
Channel Lag 1 & 2 Rate	57
Poly Key Timer	57
Channel Ramp	58
Preset PatchCords	58

5 - Effects 59

Overview	59
Programming Effects	60
Adding an Aux Effect in the Multisetup	60
Adding an Effect to a Preset	61
Block Diagram of the Effects Routing	62
FX Routing	63
Block Diagram of the Effects Screens	63
Effects Overhead	64
Typical Effects Usage	64
VSTi Bus Outputs	64
Main Output Window	65
Main Output Window	65
Proteus X Composer FX Template	66
Aux FX Screen	67
Aux Effects	67
Presets FX Screen	68
Presets Effects	68
Presets FX Modulation Parameters	69
Creating, Deleting & Reordering Templates	70
Effects Listing	72
Effects Descriptions	72
Background: Reverb	72
Reverb	73
Early Reflections Reverb	73
Reverb Lite (mono)	74
Chorus	75
Background: Chorus	75
Chorus / Delay	76
Compressor	77
Basic Controls	77
Delay	79
Background: Delay	79
Discrete stereo	79
Ping Pong, stereo	80
Ping Pong, mono L->R	80
Delay (BPM)	82
Early Reflections	83
1-Band Para EQ	83
4-Band EQ	84
Flanger	85
Growl	86
Limiter	87
Phaser	88
Pitch Shifter (mono)	89
Ring Modulator	90
SP12-ulator	91
Tremulator BPM	92
Tube	94
Twin	95

6 - Controls 97

The Toolbars	97
Viewing and Hiding the Toolbars	98
Drag & Drop	98
Changing Settings	98
Entering Numeric Values	98
View Menu	99
Main Display View	100
Tree View	100
Tree Navigation using the Keyboard	101
Cursor Keys	101
Find Items	101
Refresh (F5)	101
Context Sensitive Menus	101
Undo/Redo	101

7 - Synthesizer Basics 103

Editing Presets	103
Modulation	104
Modulation Sources	104
Keyboard Key	104
Key Velocity	104
Release Velocity	104
Gate	104
Key Glide	104
Pitch and Mod Wheels	104
Keyboard Pressure (mono aftertouch)	105
Pedal	105
Miscellaneous Controllers A -P	105
Low Frequency Oscillators (2 per voice)	105
Envelope Generators (3 per voice)	105
Function Generators (3 per voice)	105
Noise & Random Generators	105
T-switch and Footswitches	105
Modulation Cords	105
Envelope Generators	106
Retriggering	106
Complete Mode	106
Low Frequency Oscillators (LFOs)	107
Random Sources	108
Clock Modulation	108
Syncing an LFO to the Clock	108
Function Generators	109
Modulation Destinations	110
Modulation Processors	111
Dynamic Filters	112
What is a Filter?	112
Parametric Filters	115
The Z-Plane Filter	116
MIDI Channels & Real-time Controls	117
MIDI Program Change Commands	119
MIDI Bank Select Commands	119
Background: Bank Select Commands	119
MIDI Modes	119

8 - Appendix	121
Keyboard Shortcuts	121
Right Click Shortcuts	121
Toolbar Functions	122
MIDI Implementation Chart	123
MIDI Implementation Chart (part 2 - Controllers)	124
Special Notes:	127
Controller Functions	128
 Index	 129

1 - Introduction & Installation

Introduction

The Proteus VX is a professional desktop sound module based on the Proteus sound modules and Emulator samplers. The engineers and designers at E-MU Systems have brought their years of experience and expertise together to create the most comprehensive and flexible software instrument ever.

Proteus VX uses the renowned Emulator 4 Ultra/Proteus 2000 synthesis architecture as its synthesis engine. Although not all the modules are user-programmable in the VX version, they are working behind-the-scenes to provide you with truly awe-inspiring sound.

Proteus VX

Proteus VX allows quick and easy creation of multitimbral setups on up to 16 different MIDI channels. The Proteus VX sound engine contains the following features:

- 24-bit playback
- Up to 192 kHz sample rate
- 32-bit floating point internal processing
- Drag and drop preset selection
- Phase Locked Stereo signal path
- Ultra High Precision Pitch Interpolation (user selectable)
- High Voice Polyphony (system dependent)
- Real-time controllers for all important control points
- 54 different filter types including multi-pole resonant filters, phasers, flangers, vocal filters and multi-parameter morphing filters.

Note: The following features are not user-programmable in Proteus VX.

- Extremely powerful voice and sample zones can be crossfaded by position, velocity or real-time controller up to 128 layers deep.
- Three multi-stage envelopes, three 64-stage function generators, two lag processors and two multi-wave LFO's per voice.
- Super-flexible PatchCord modulation matrix allows any modulation source to be connected to any destination.

Before you Begin...

You should have a good working knowledge of your computer's operating system. For example, you should know how to use the mouse, standard menus and commands. You should also know how to cut, copy, paste, open and close files.

Notes, Tips and Warnings

Items of special interest are presented in this document as notes, tips and warnings.

- ◆ **Notes** provide additional information related to the topic being discussed. Often, notes describe the interaction between the topic and some other aspect of the system.
- **Tips** describe applications for the topic under discussion.
- ▼ **Warnings** are especially important, since they help you avoid activities that can cause damage to your files, your computer or yourself.

System Requirements

To use Proteus VX you will need at least:

- Pentium III 1GHz or equivalent CPU (P4, 2 GHz or faster recommended)
- 512 MB RAM (1 GB DDR or greater recommended)
- Windows XP or Windows Vista
- (optional) A VST host application capable of running VST instruments (VSTi)

Software Installation

Programs installed

- Proteus VX standalone application
- Proteus VX VSTi application (virtual instrument used in a host sequencer application)
- Proteus X Composer Sound Bank

1. Insert the CD or DVD labeled **E-MU Audio Production Tools** into your CD-ROM drive.
2. If Windows AutoPlay mode is enabled for your CD-ROM drive, the CD starts running automatically. If not, from your Windows desktop, click Start->Run and type d:\setup.exe (replace d:\ with the drive letter of your CD-ROM drive).
3. The installation splash screen appears. Check the box labelled, **Install Proteus VX** and click OK.
4. Follow the instructions on the screen.

The Proteus VX applications have been installed inside "Program Files/Creative Professional/ProteusVX."

5. Look for any "ReadMe" files in the Proteus VX folder or in the Start menu and read these before continuing. The readme files may contain important last minute information that didn't make it into this manual.
6. Remove the E-MU Audio Production Tools disk from the CD-ROM drive.

Optimizing Your Computer for Proteus VX

Windows: The following suggestions can help you configure your windows machine for optimal performance. Since systems vary, we recommend that you note the original settings of any system parameters you alter so that you can restore them in the event that unexpected problems occur as you seek to optimize your system for Proteus VX:

- Seriously consider dedicating a computer as your audio workstation. This computer can be optimized for best audio performance.
- If possible, avoid assigning slower devices to the IDE controller used by your audio drive.
- Get the fastest hard disk drive you can afford. Many drives now offer an 8MB - 16MB data buffer, which can also improve performance.
- Defragment your hard drive often.
- Perform a "clean" install of your operating system with only the minimum components and programs installed.
- Use the System Restore feature of Windows XP or other restoration programs such as "Norton Ghost"™ to make backups of your system for easy recovery and system maintenance.

◆ **Proteus VX** is a "Lite" version of our standalone Proteus X2 and Emulator X2 products. Proteus VX allows basic preset and effects programming.

Proteus X2 provides extensive synthesizer preset programming.

Emulator X2 contains all features of Proteus X2 and adds intelligent sampling and a host of powerful sample editing features.

Setting up Cubase LE4 and Proteus XVSTi

Proteus VX VSTi is a VSTi (Virtual Studio Technology instrument) which means that it "lives" inside of a VST "host" application such as Cubase LE. These instructions pertain to Cubase LE 4 since it is supplied in the "E-MU Audio Production Tools" software bundle. This information can be applied to other applications as well.

1. **Open Cubase LE 4** from the Start menu. An ASIO multimedia driver test dialog box will pop up to ask if you want to run the ASIO test. Choose **No**, because you won't be using the driver anyway.
2. Select **New Project** from the **File** menu.
3. Select **Empty** and click **OK**.
4. A **Select Directory** pop-up dialog box will appear. Choose a location on your hard disk where you want to store your audio files, then click **OK**.
5. The Cubase LE 4 Project window appears.
6. Select **Device Setup...** from the **Devices** menu.

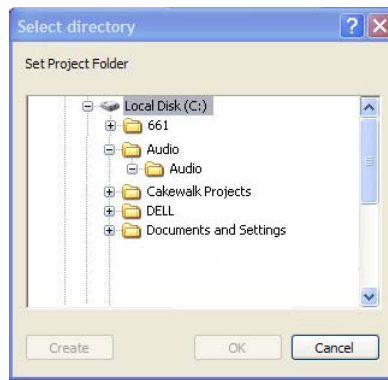

TIP . . .
If you have two or more hard disks, it's better to store audio files on a disk that isn't running your OS.

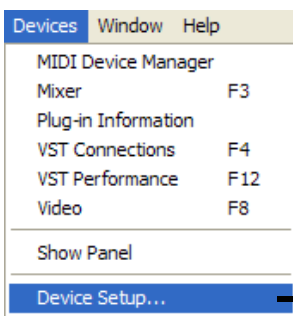

Step 10:
VST
Audio

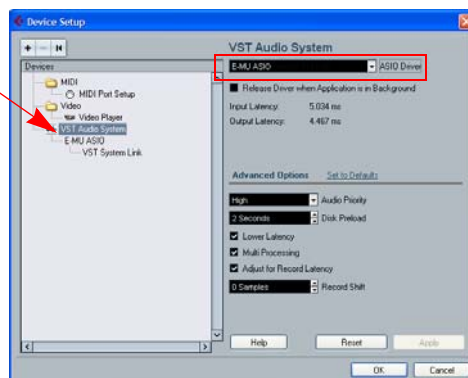

7. Select **VST Audio System** from the left pane.
8. Select the ASIO Driver. Choose your E-MU interface from the list. Choose: **E-MU ASIO (0404, 1212, 1820, 1616 Digital Audio Systems), ASIO E-MU 0404|USB, ASIO E-MU 0202|USB, or ASIO E-MU TRACKER Pre|USB.**
9. A pop up dialog box asks you if you want to keep or switch the ASIO driver. Select **Switch.**

WARNING!
 DO NOT select the "ASIO Multimedia Driver" or the "ASIO Direct X Full Duplex Driver."

Buffer Latency Setting

10. Click on the name of your E-MU interface that appears immediately below **VST Audio System** in the Devices pane. Refer to the following screen.

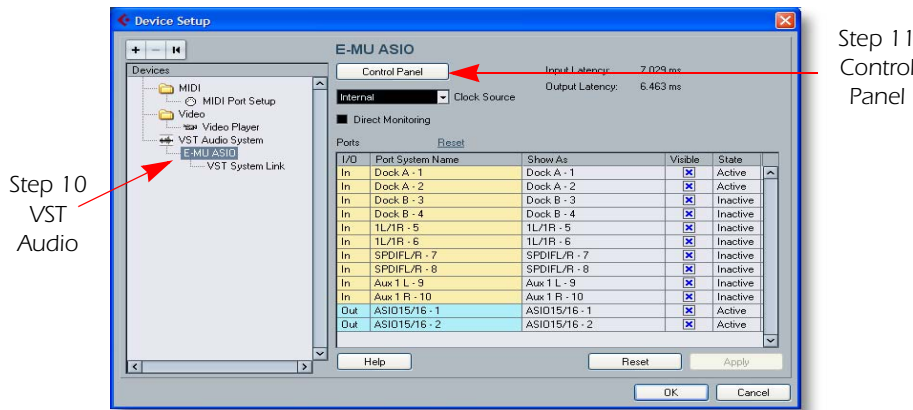

11. Click the **Control Panel** button. The pop-up dialog box shown at right appears.
12. Set the **ASIO Buffer Latency** as low as your computer will allow and click **OK**. (10ms is a good starting point.) A low latency setting is important to assure fast response when using virtual instruments and to minimize delay when monitoring through Cubase. If you hear crackles or other audio problems, try increasing the Buffer Size.

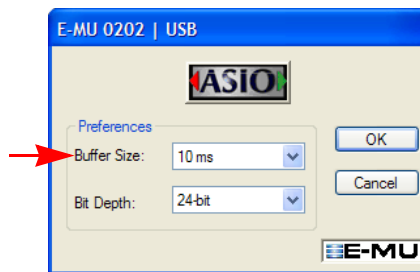

NOTE
 E-MU 0202 Control Panel is shown at left. The Bit Depth field does not appear with 0404PCI, 1212, 1820 or 1616.

13. Close the Device Setup screen by clicking **OK**.

Setting up a New Project

14. Select **New Project** from File menu in Cubase LE 4. A pop-up Template selection dialog box appears. Select **Empty**, then click **OK**.
15. Another pop-up dialog box appears asking you to select the directory in which your audio files will be stored. Choose a location to store your audio files and click **OK**.
16. Select **Project Setup** (Shift +S) from the **Project** menu. This is where you set the Sample Rate and Record Format (bit depth), among other things. Set the Record Format to **24 Bit** and the Sample Rate to **44.100 kHz**.

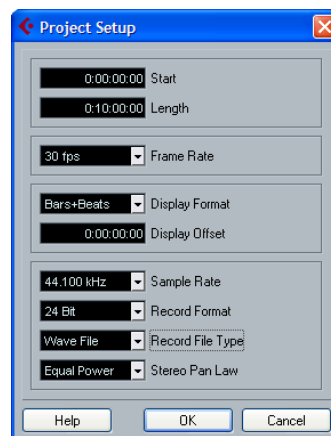

WARNING!
 If the Cubase LE 4 application crashes for any reason, it is recommended that you re-boot the computer.

Optional - Add Additional Input Busses

If you are using an audio interface that has more than two inputs (0404 USB, 0404, 1212, 1616, 1820), the following instructions will allow you to select these extra inputs to feed your audio tracks.

17. Select **VST Connections** (F4) from the **Devices** menu.

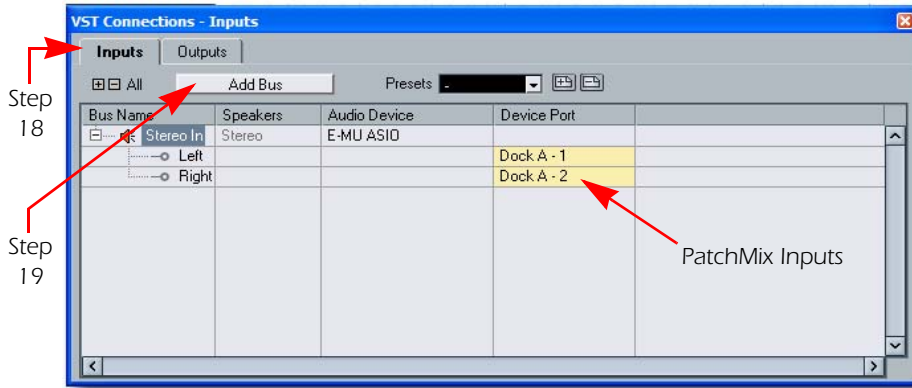

18. Select the **Inputs Tab**, revealing the window shown above.

19. Click the **Add Bus** button. The pop-up dialog box shown at right appears.

20. Select the number of mono or stereo input busses you want, then **click OK**.

21. Additional mono or stereo busses appear in the list. Note that the actual PatchMix input label appears in the Device Port field.

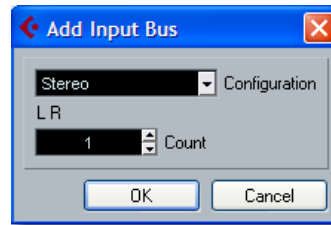

22. Close the window by clicking the close box. The inputs you added will now be available for selection in the Track Input field of the Inspector pane.

TIP . . .

You can also Rename your Input Busses here to avoid confusion when assigning Inputs to tracks.

Running Proteus VX VSTi from Cubase LE4

These instructions explain how to start Proteus VX from within Cubase LE 4. If you have a MIDI keyboard, you should connect it now using the setup diagrams and instructions that came with your E-MU Audio Interface. Without a keyboard, you will only be able to play one note at a time using the mini keyboard on Proteus VX.

You'll need a MIDI interface and a MIDI keyboard (or other MIDI input device) for this tutorial. Please refer to the Proteus VX manual for the complete set of instructions (*located under the Help menu item*).

Make the Connections

1. Connect the MIDI out of your MIDI keyboard to the MIDI input of your MIDI interface.
2. From the **Project** menu, select **Add Track, Instrument**.

1 - Introduction & Installation
 Running Proteus VX VSTi from Cubase LE4

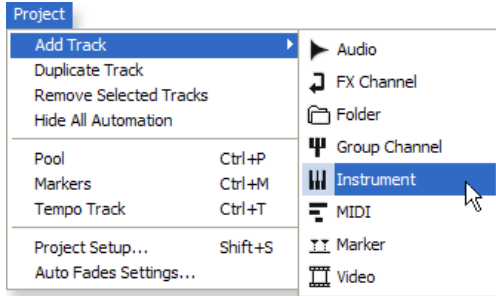

3. A pop-up dialog box appears asking you to select a VST Instrument. **Select Proteus VX.** Select a **Count of 1.** Click **OK.**

NOTE
 Selecting a Count of 2 or more, instantiates multiple copies of Proteus VX, which results in very inefficient usage of your CPU. (See the note on [page 16.](#))

NOTE #2
 If you have Proteus X or Emulator X, you can select these in place of Proteus VX.

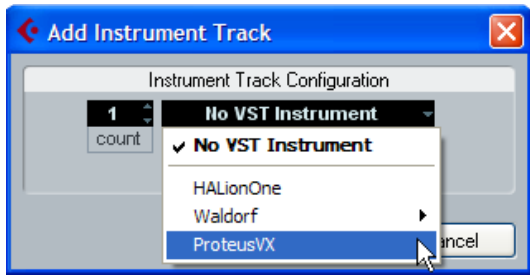

After a short delay, the Cubase Project Window should now look more or less like the one below with one or more Audio tracks and one Instrument track:

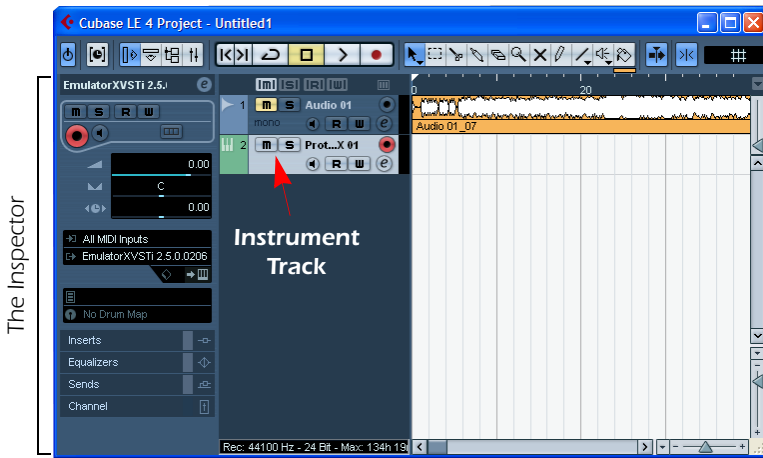

Open VX & Load a Bank

4. Since Proteus VX uses samples as the basis of its sound, you need to load a bank of samples before it can be played. The Edit Instrument button, located in the Inspector section of the window, allows you to edit the virtual instrument.
5. Click the **Edit Instrument** button. The Proteus VX main window appears.

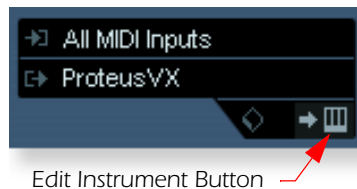

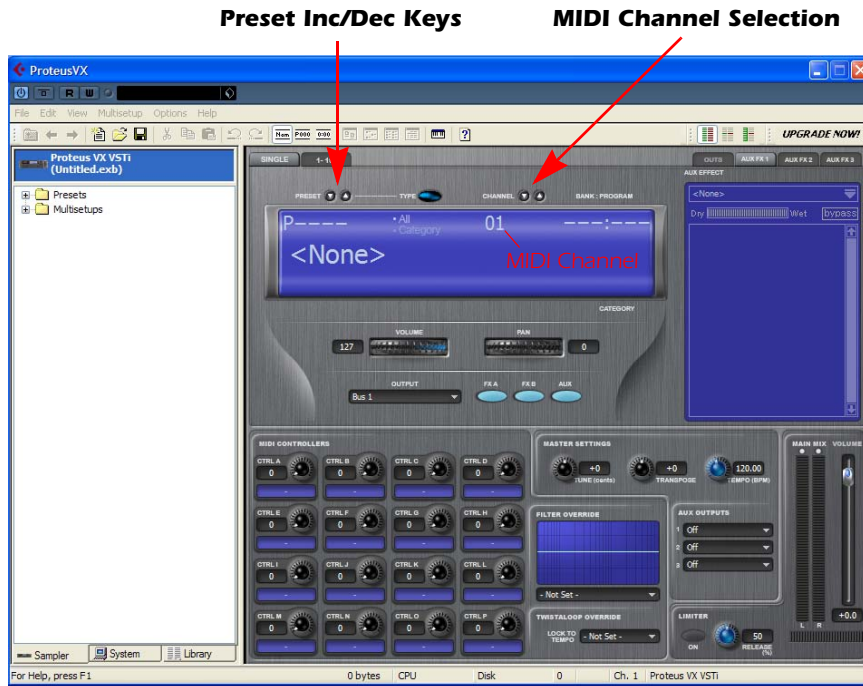

6. Now we can load the Proteus X Composer bank. **Select Proteus X Composer** from the File menu. The bank is installed here: "Program Files\Creative Professional\E-MU Sound Central\Proteus X Composer." Loading takes a few seconds.
7. **Change the Preset using the Inc/Dec keys.** You also have to select a preset before you can hear anything. There are 1024 different presets (sounds) in this huge bank.
8. Bring up the **mini keyboard**  by clicking the icon on Proteus VX and play a few notes. You should be hearing sound.
 - If the sound volume is very low, you can decrease the Headroom of Proteus VX. (Options, Preferences, Headroom/Boost) Keep in mind that with less headroom, the Proteus VX will be more prone to clipping when multiple channels are played.
9. **Play your MIDI controller** and verify that it plays Proteus VX. If not, check to make sure your MIDI keyboard is set to the same MIDI channel number as Proteus VX (*probably channel 1*).
10. Try out the MIDI Controller knobs on your MIDI keyboard. In order for these to work, the continuous controller numbers of your keyboard knobs must match those on Proteus VX. (Options, Preferences, Controllers tab).
11. Feel free to play around for awhile and don't worry about losing anything. Nothing is made permanent until you **Save** the bank, so have fun.

TIP . . .
Increase the headroom setting (more positive) to increase the volume and decrease the amount of available headroom.

To Record a MIDI Track

12. Make sure the **Record Enable** button on the MIDI track is on (it should be on by default).



13. Click **Record** on the Cubase LE Transport control and start playing your MIDI controller.



14. Press **Stop** when you're finished recording the first track.

15. Press the **Go To Start** button. |<

16. Press **Play** > on the Cubase Transport to play back your track.

To Record a MIDI Track on another MIDI Channel

NOTE: Proteus VX VSTi can play back up to 16 MIDI tracks at once, however, the LE version of Cubase 4 only supports a single MIDI channel per VSTi. You *could* load another instance of the Proteus VX for each channel, but this is a very inefficient usage of your CPU resources and is **NOT recommended**. The full version of Cubase 4 does support multiple MIDI channels on a single VSTi.

Program Changes

Cubase LE 4 allows you to insert **MIDI Program Change** messages in the MIDI sequence. (Key Editor, List Editor, Insert Program Change) This trick makes it possible to use more than one Proteus VX preset in a song.

On Your Own

Feel free to play around for awhile and don't worry about losing anything. Nothing is made permanent until you **Save** the bank, so have fun. When you're ready, look over the rest of this manual. If you want a tour of the Proteus VX, be sure and check out Chapter 2 - Guided Tours.



**Proteus VX
Main Window**

Troubleshooting Checklist

No MIDI Keyboard Control?

- Is the MIDI Track input set to the proper MIDI port?
- Does the MIDI indicator on Cubase SE light up when you play?
- Check the Cubase LE "Devices" menu

No Audio?

- Do you see activity on the Main Mix meters of Proteus VX when you play the mini keyboard?
- Is your audio device selected in the Proteus VX Preferences?

Setting up the Preferences

The preferences dialog box contains a variety of important controls used to configure Proteus VX for your audio hardware and to customize the controls to suit the way you work.

► To Access the Preferences Dialog Box

1. Select **Preferences** from the **Options** dialog box. The following screen appears.

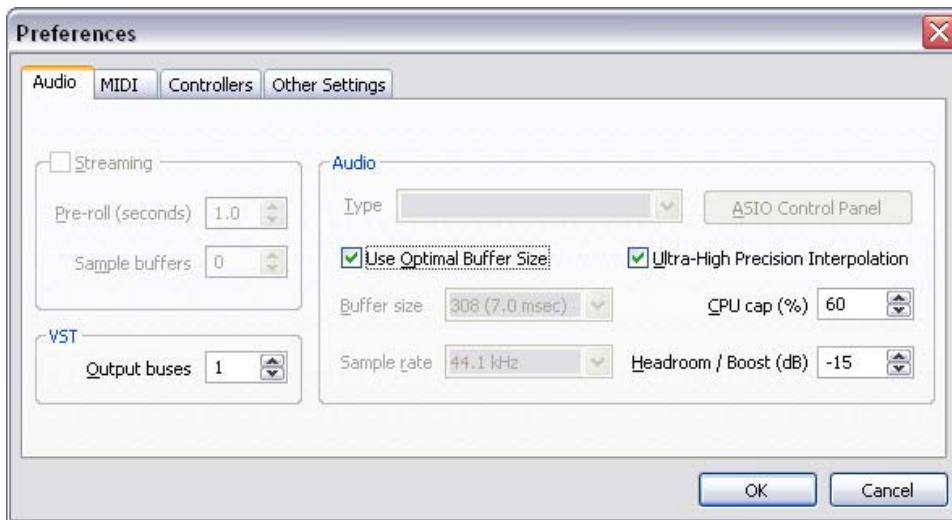

2. The preferences dialog box is divided into four main groups. Click on the tab heading to select one of the four sets of controls.

Audio	Audio Hardware Setup & Pitch Shift Algorithm selection, number of VST Output buses.
MIDI	Receive/Ignore Program Changes, Internal/External Tempo Source select, Velocity Response Curve, Volume Curve, Volume Sensitivity
Controllers	This section allows you to set up the MIDI Continuous Controllers you want the Proteus VX to receive.
Other	Clear clip indicators after 10 seconds

Audio Preferences

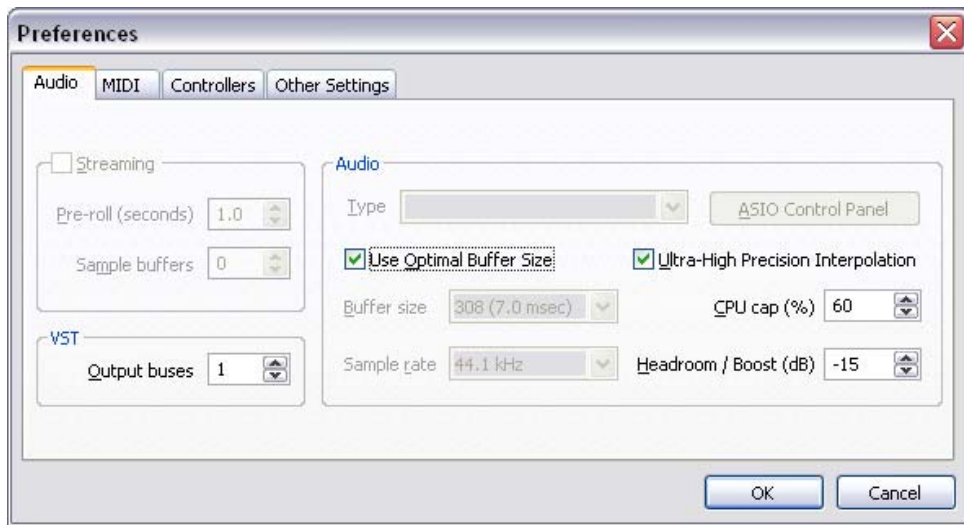

Audio Setup

These controls let you set audio quality parameters related to Proteus VX and your sound card.

Use Optimal Buffer Size

When this box is checked, the Proteus VX will choose the best buffer size based on the ASIO Buffer Latency setting (located in the ASIO control panel). You should normally leave this feature enabled for best audio performance. In certain rare cases you may want to manually set the buffer length to improve MIDI or synth performance.

Buffer Size

This control sets the number of sample periods between updates of the synthesizer parameters. The buffer size can be adjusted according to the speed of your computer's CPU. A faster CPU can handle a lower buffer size. The default buffer size changes with the latency setting when "Optimal Buffer Size" is checked.

Sample Rate

This control displays the output sample rate of the Proteus VX, and will always match the sample rate of your sound card. The default setting is 44.1kHz.

CPU Cap

This important control sets the percentage of CPU resources that will be used by Proteus VX and consequently the maximum number of samples that can be played at the same time. Depending on the design of the preset, a single Proteus VX voice may contain multiple samples which play simultaneously. The maximum setting is 80% CPU usage. If you hear notes being "stolen" in your sequence or as you play the keyboard, or if the disk meter readout at the bottom of the window goes into the red, increase the value of this control. If you have other applications running, you may want to reduce the setting of this control to free up more CPU for them.

▼ **Warning:** Sounds with long release times will exhibit "voice stealing" more than short percussive sounds.

■ **Tip:** When running multiple VSTis, distribute the CPU Cap among the VSTis. Example: If one VSTi does not glitch at 60%, set the CPU Cap of two VSTis so they add up to 60%.

Headroom/Boost

Headroom is the amount of dynamic range remaining before clipping occurs.

The amount of headroom is adjustable from 12 dB to -30 dB in 1 dB increments. A headroom setting of 12dB provides the hottest output level, (and the highest signal to noise ratio) but may produce “clipping” if too many notes are played at once. The default headroom setting is -7 dB, which maintains an excellent signal to noise ratio while keeping a reasonable amount of headroom in reserve. **If you hear the signal clipping or breaking up, decrease the headroom value.** In practice, you can think of this control as adjusting the control range of the Master Volume control.

Ultra-High Precision Interpolation Button

This button allows you to select between E-MU’s ultra-high precision pitch shifting algorithm or a lower quality pitch shifting scheme which uses fewer CPU resources.

If you are using presets with a sample placed on every key, as is the case on many banks, you can switch high precision off to free up CPU with no penalty in audio quality. No pitch shifting is occurring anyway. High quality pitch interpolation is only needed when you are playing presets which have a few samples mapped across the entire keyboard. In this case, the Proteus VX shifts the pitch of the available samples to fill in the keyboard.

◆ **Note:** The “Audio Type” and “ASIO Control Panel” parameters cannot be edited in Proteus VX. They will always appear “greyed-out”.

VST Output Buses

This setting allows you to add additional VST buses (stereo pairs). Proteus VX channel outputs can be assigned to VST buses in the Multisetup, Output field. These outputs are sent to the VST Mixer in your recording application. You must restart the VSTi for the changes to take effect.

Unlike some VSTi’s, Proteus VX is multitimbral, able to play up to 16 MIDI channels at once. It’s far more CPU-efficient to have multiple MIDI channels playing on one instance of Proteus, rather than have multiple VSTi’s running. Using VST Output buses, you can route each MIDI channel to a separate bus in Cubase.

MIDI

This group of preferences allows you to set up the MIDI inputs, adjust the master MIDI volume and velocity curves.

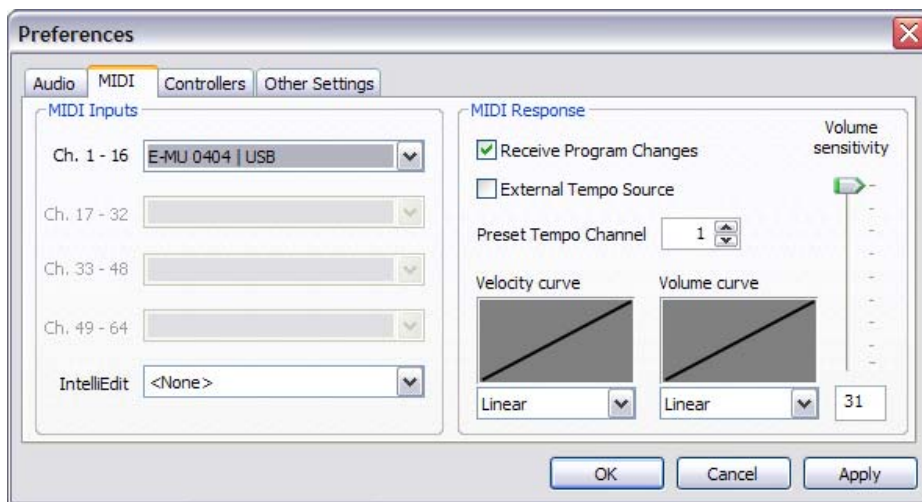

◆ **Note:** The “IntelliEdit” feature is not applicable to Proteus VX. The field will always appear “greyed-out”.

MIDI Inputs

Receive Program Changes

This check box selects whether or not MIDI Program Change messages from your MIDI controller or sequencer will be received or ignored by the Proteus VX. Place an X in the check box to receive program changes.

External Tempo Source

This check box selects between internal tempo clock or MIDI clock as the tempo source. The Proteus VX uses a global master tempo for Tempo-based Envelopes, Tempo-based LFOs, and clock modulation. When this check box is selected, MIDI clock will be used for the global tempo and the tempo control in the Multisetup window will be disabled.

Preset Tempo Channel

The tempo of Proteus VX can be specified in the preset so that selecting a preset on a specific MIDI channel changes the tempo. This option selects the MIDI channel whose preset will be used for Tempo Control. This feature allows the proper tempo to be set when a Tempo-based or Twistaloo preset is selected.

For example, suppose you have this field set to channel 1 and the preset on MIDI channel 1 has its Tempo Control set to 122.22 BPM. When the bank is loaded, the Tempo will be set to 122.22 BPM. If you change the preset on channel 1, the tempo will change to follow the "Initial Tempo" setting in the new preset. (See [page 53](#).)

If the preset on the Preset Tempo channel has its Tempo Control set to "Off", (or if this option is set to "Off") no tempo change occurs when the preset is selected.

MIDI Response

These controls allow you to customize the MIDI response of the Proteus VX to match your MIDI Controller or other instruments.

Velocity Curve

Incoming velocity values can be scaled by one of 24 curves to better adapt to your playing style or MIDI controller. Selecting "linear" leaves the velocity data unaltered. The shape of the selected curve is displayed in the window. Select the curve that feels best with your MIDI keyboard.

Volume Curve

This is an adjustment to help match MIDI controller #7 volume response to other manufacturers' equipment. Three curves are provided: Linear, Inverse Square or Logarithmic. The action of this control is displayed in the window.

Volume Sensitivity

This control allows you to modify the response curve for MIDI continuous controller #7 (Volume). This allows you to match the Proteus VX's response to other manufacturers' equipment. Low numbers compress the volume control range, raising the volume level at lower controller #7 values.

▼ Important!

If External Tempo Source is set to external, the tempo control in the Voice Editor will be "greyed-out" and non-functional.

Controllers

This is where you set up which MIDI Continuous Controllers the Proteus VX will receive. Match these controls to the MIDI continuous controller numbers that your keyboard or sequencer transmits. What the controllers actually do is pre-programmed in each preset.

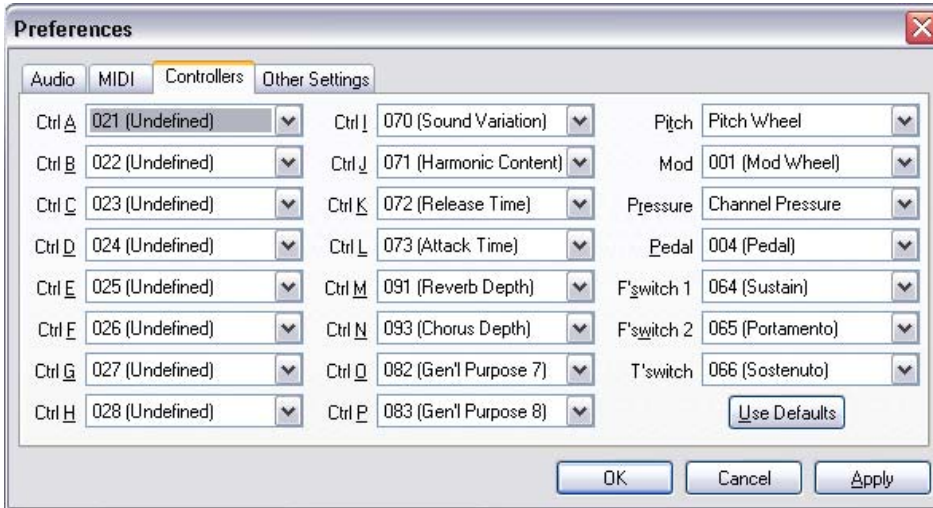

As you can see, MIDI Continuous Controller numbers are assigned to letters (A-P) or labels (Pitch, Mod, Pressure, Pedal, etc.) in this screen. When a preset is programmed, these letter or name labels are assigned to control various parameters such as filter frequency or attack time.

The name labels such as pitch and mod wheels are so commonly used that they have their own assigned name, but these can also be freely assigned in any way you choose.

If you're just getting started, it's probably best to use the default settings. Press the "Use Default" button to restore the default settings which are shown above.

Other Settings

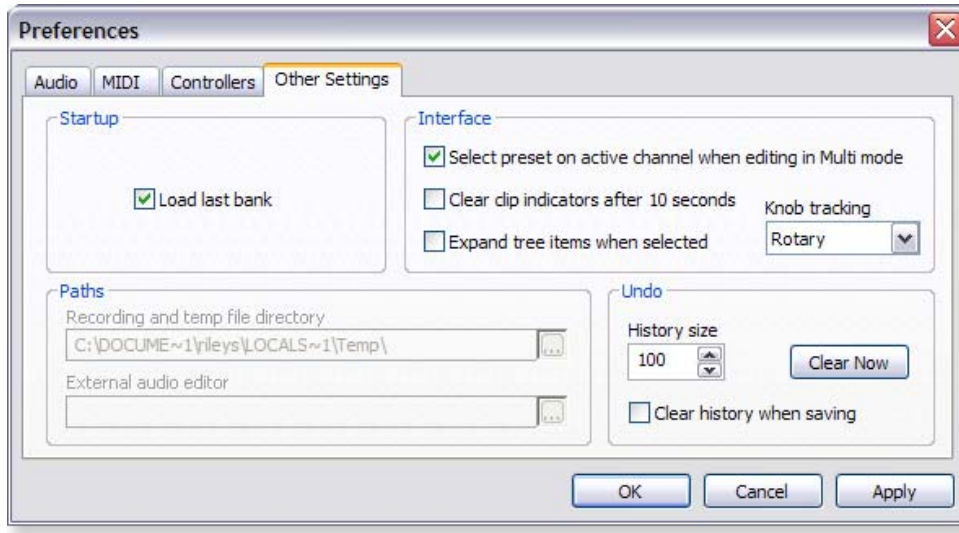

Startup

- **Load last bank** - This feature automatically loads the last bank you had loaded whenever you start the Proteus VX application.

Interface

- **Select preset on active channel when editing in Multimode** - When checked, selecting a preset for editing in the Tree selects that preset on the active channel in the multisetup. This is what you want if you're editing a preset and playing a MIDI keyboard.

If you're playing back a multi-timbral sequence and want to make a quick edit to a preset, you might want this feature Off so as not to alter your multisetup.

- **Clear clip indicators after 10 seconds** - This feature automatically clears the main output meter clip indicators. If this function is set to Off, the clip indicators will stay on until you manually click on them.
- **Expand tree items when selected** - If this option is checked, selecting presets from the Tree will automatically open the selected preset for editing. When unchecked, selecting presets from the Tree will select the preset for playing, but not open it for editing.
- **Knob Tracking** - This control allows the rotary knobs to be manipulated with either Rotary, Horizontal, or Vertical motion. The setting affects all rotary controls.

Undo

- **History size** - The maximum number of stored undo steps.
- **Clear history when saving** - Clears all undo history when you save a bank. If you have this box unchecked, you can undo even when you save and re-open a bank.
- **Clear now** - Clears the undo history immediately.

Appearance Settings in Windows

Adjusting the “Performance Options” in Windows will make the Preference buttons much easier to read and increase the smoothness when dragging windows around on the screen.

► To Improve the Appearance Settings:

1. Open the Windows **Control Panel**. (*Start, Settings, Control Panel*)
2. Select **System**.
3. Select the **Advanced Settings** tab.
4. Select **Settings** in the Performance section
5. Under Visual Effects, select **Adjust for Best Performance**.
6. Click **OK**.

Proteus VX Question & Answer

► **The Controller knobs on my keyboard don't work with Proteus VX**

A The controller numbers sent by your MIDI keyboard must match the controller numbers that Proteus VX is receiving. See [“MIDI Channels & Real-time Controls” on page 117](#). Also see [“Controllers” on page 22](#) to change the MIDI controllers that Proteus VX receives.

► **There is a huge delay when I play Proteus VX from a MIDI keyboard**

A Lower the ASIO Buffer Latency setting on your host application. An ASIO Buffer setting of 10ms or below will be acceptable for most players.

► **Parts are cutting out in my sequence**

A #1: You may be exceeding the capacity of your computer's CPU. When multi-tracking using VSTi's and VST effects, it might be a good idea to “Render” or “Freeze” the tracks to free up CPU resources.

A #2: You might try increasing the **CPU Cap** parameter in the Preferences menu ([page 19](#)). This setting controls the amount of CPU resources that Proteus VX is allowed to use.

A #3: Turning **Ultra High Interpolation** Off in the Preferences menu frees up CPU resources at the expense of audio quality. Use your ears to decide.

A #4: Are you running multiple instances of Proteus VX? **Don't.** Proteus VX was designed to be run as a single instance using multiple MIDI channels. Running more than one instance of VX is extremely wasteful of your CPU resources.

► **Can I play SoundFonts with the Proteus VX?**

A No, but the full versions of Proteus X2 (and Emulator X2) include a File Converter program which converts SoundFonts to the Emulator format used by Proteus VX.

► **Can I play General MIDI files using the Proteus VX?**

A No, but the full versions of Proteus X2 (and Emulator X2) include a General MIDI bank. This bank will load into Proteus VX.

► **Can I send different MIDI channels to separate outputs?**

A Yes. The **VST Output Bus** setting ([page 20](#)), lets you add additional VST buses. After additional buses are created, Proteus VX channel outputs can be assigned to VST buses in the Multisetup, Output field.

► **How do I find out the number of samples used per note?**

A Play a single note on the keyboard and look at the “Samples Playing” display at the bottom of the window. Please refer to the diagram on [page 28](#).

2 - Guided Tours

Exploring the Tree

In this section you'll learn how to navigate around Proteus VX using the Tree. Don't worry if you don't know what everything does just yet. All the details will be explained later on.

1. With the Proteus VX application running, a bank is loaded by selecting Open from the File menu. Click on the **Presets Folder** in the Tree and a screen, similar to the one shown below, appears.

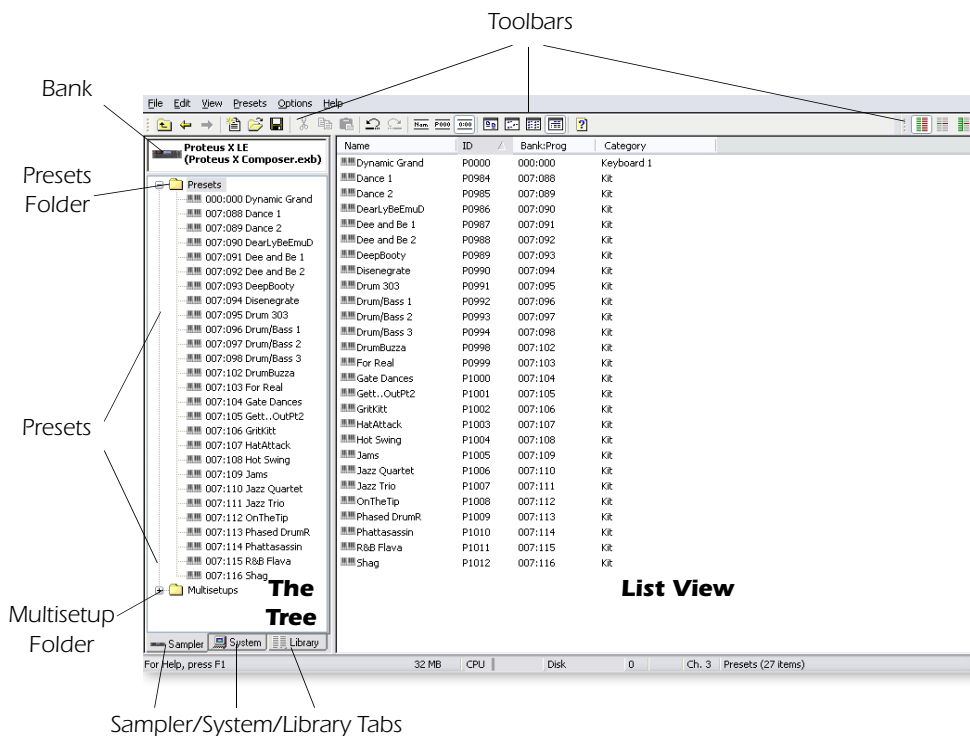

The **Tree** is the section shown on the left of the screen. There are three tabs at the bottom of the Tree labeled **Sampler**, **System** and **Library**.

Sampler Allows you to see the contents of the current Proteus VX bank.

System This tab gives you access to your entire computer system: PC, hard disks, CD-ROM drives, network, etc. Presets and Multisetups can be browsed, then Merged into the current Bank. **Load Emulator IV banks from this tab.**

Library The Library shows you all Emulator X and Proteus VX related files, wherever they may be located on hard disks, CD-ROM or network. Presets and Multisetups can be browsed in the Library, then Merged into the current Bank.

▼ E4/E3 CDs use a proprietary format and can only be read using SCSI/ATAPI drives. They cannot be read using firewire and USB drives.

Multisetup Page

The Multisetup is the top level of the Proteus VX hierarchy and is the place where you choose presets and assign them to each of the MIDI channels.

A multisetup assigns a preset, volume, pan position and output routing to each of the 16 MIDI channels. Multisetups can be saved and recalled for use with a particular song or sequence so that all the MIDI channels play the proper preset.

Click on the Proteus VX icon to display the Multisetup page.

There are two views in the Multisetup page. The **Multisetup View** buttons change the current view. The **Single** channel view is shown below.

- **Single**..... Displays the preset for the currently selected MIDI channel.
- **Channels 1-16**.. Displays the preset, volume and pan for MIDI channels 1-16.

See [page 37](#) for a complete description of the Multisetup screen.

Single Channel View

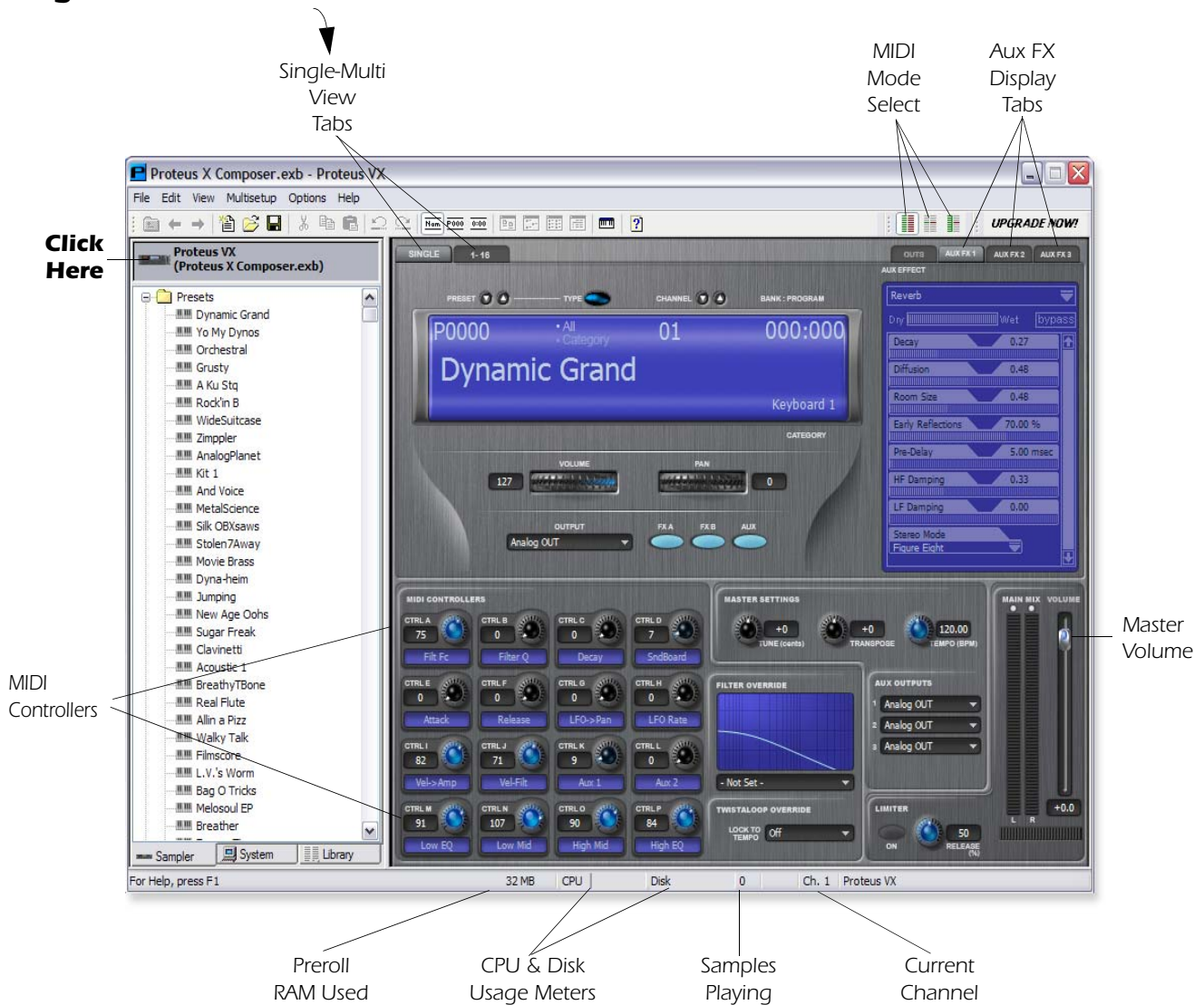

Changing Presets (from Single View)

Single View is the default view when you first run Proteus VX. This view is convenient for performing live or when you're only playing one preset at a time. All the main parameters for the selected MIDI channel are displayed in Single View and a convenient Category mode allows you to quickly select presets in a certain category. A close-up of the current channel settings is shown below.

Single View Close-up

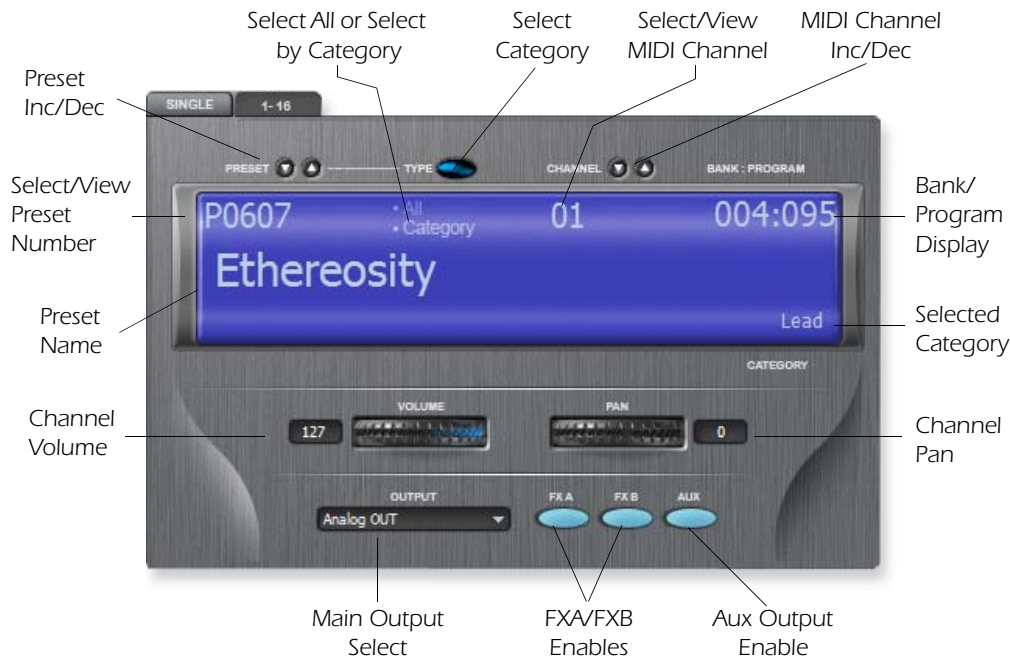

◆ Note that Single View only changes the display and does not affect the currently selected MIDI mode (i.e. Omni, Poly or Multi).

◆ The Bank/Program Display shows the Bank and Program number you would use to select the preset from a sequencer.

► To Select Presets by Number

1. Click on the **Preset Increment/Decrement** buttons to move up or down the presets by number.
2. Highlight the **Preset Number** field and type in the desired preset number.

► To Select Presets by Category

1. Click on the **Select Category** button. The pop-up dialog box at right appears.
2. Select the desired preset category, then press **OK**.
3. Choose **Select By Category** from the Single view screen above.
4. Use the **Increment** or **Decrement** buttons to select presets. Note that only presets of the selected category are selected.

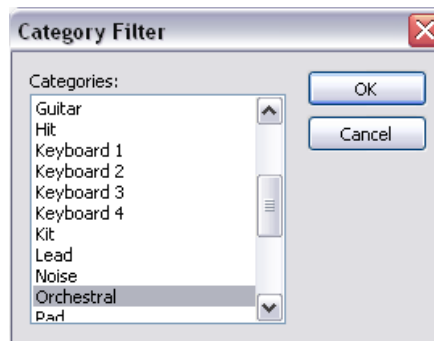

► Changing the Current MIDI Channel

The Current MIDI Channel is simply the MIDI channel you are currently working with. To change the current MIDI channel, simply increment or decrement the channel number using the buttons, or click on the channel number and type in the desired number.

Channel 1-16 View

Press the Multisetup View 1-16 button to view channels 1-16 at the same time.

This page view is particularly useful when sequencing as you can see 16 MIDI channels at once. Note that the Output Display button is now active. See also [“3 - Multisetup / Global Controls”](#) on page 37.

Channel 1-16 View

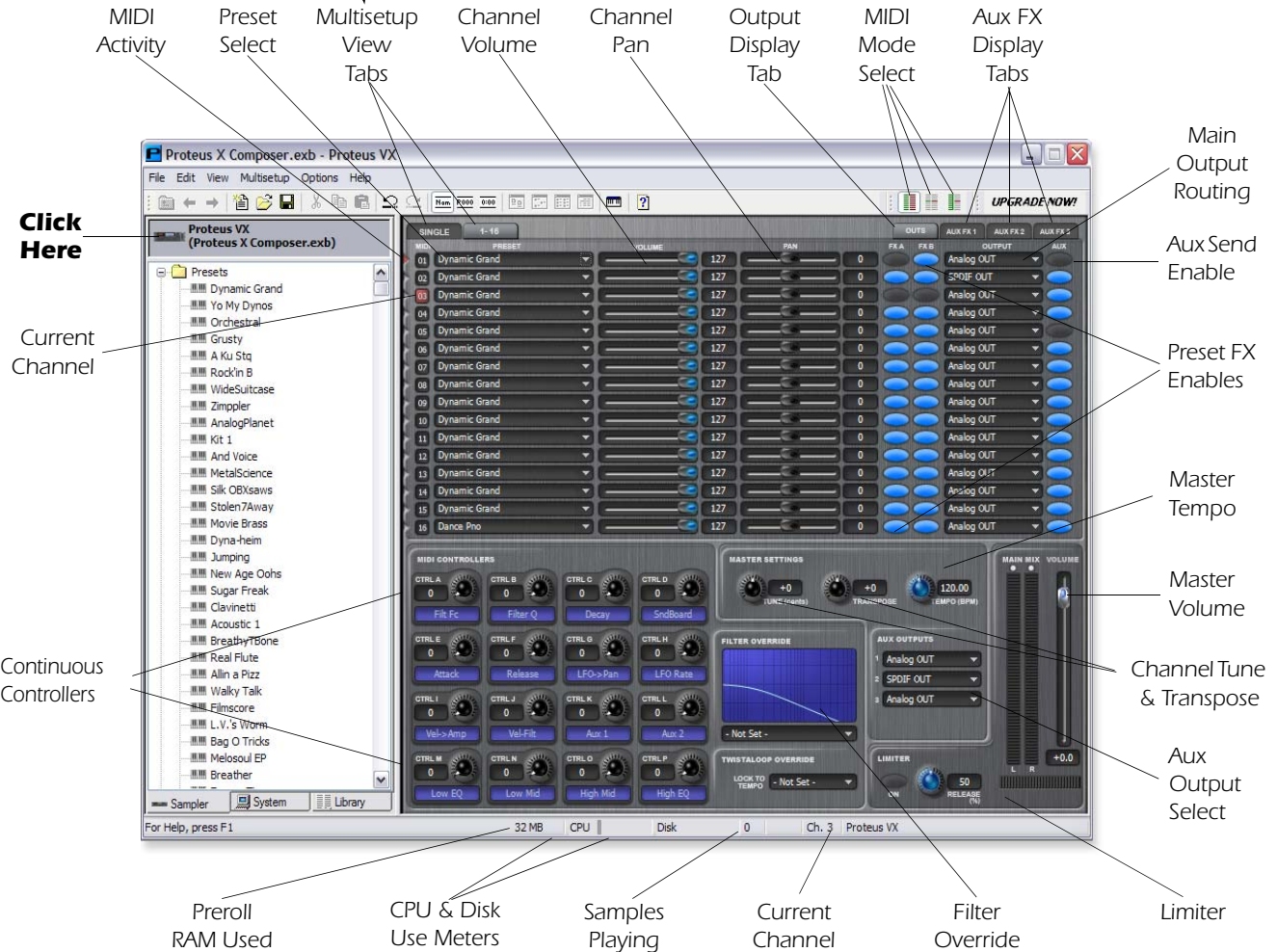

Changing Presets (from the 1-16 view)

Play your MIDI keyboard and note that one of the MIDI activity LEDs comes on. This is the channel on which your MIDI keyboard is transmitting. If you don't see MIDI activity, check your MIDI connection and make sure MIDI is set up properly in the Preferences menu. See [page 20](#).

► To Audition and Select Presets

1. Click once on the **Preset Select** button on the channel used by your MIDI keyboard. The complete list of all presets in the bank appears.
2. Click once on a **preset** to audition it. Play your keyboard to hear it.
3. Try out a few more presets. When you find one you like, double-click on it to select it and return to the Multisetup screen.

4. Change the current channel by clicking on the number to the left of the preset. The number you selected turns yellow.
5. Play the small keyboard at the bottom of the screen. Notice that the MIDI Activity LED of the current preset now plays along with whatever sound is selected for that channel. (Your MIDI keyboard still plays on the channel to which it is set.)
6. Change the channel on your MIDI keyboard then play it. The Proteus now plays the preset on that channel.

■ Selecting “None” in the Preset field, disables the MIDI Channel.

► **Selecting Presets from the Tree**

1. When you click on a preset in the tree, you have just selected it for the current MIDI channel. This action also calls the Preset Global page.
2. To go back to the Multisetup page click the **back arrow** or click on the **Proteus VX icon** at the top of the tree.

► **Changing the Current MIDI Channel**

1. The Current MIDI Channel is simply the MIDI channel you are currently working with.
2. To change the current MIDI channel, click on the channel number in the Multisetup page. The selected channel number turns yellow. Note also that the channel number at the bottom of the window changes to reflect the current channel.

Adjusting the Controllers

Each preset has a set of 16 continuous controllers which are used to adjust and control the sound as you play. Your MIDI keyboard may have several knobs or sliders that are transmitted over MIDI. These can be used to control the Proteus VX if you match the CC numbers your MIDI keyboard transmits to the same CC numbers on the Proteus VX. These global settings are located under Options, Preferences, Controllers.

See [page 22](#) and [page 117](#) for additional information about MIDI controllers.

See [page 128](#) to see a chart of the Proteus VX MIDI controller functions.

► **To Modify the Sound using the Controllers**

1. Play your MIDI keyboard as you adjust the controller knobs on the screen. Notice that the sound changes. If the sound doesn't change, make sure the current preset (red number) is the same one that your keyboard is playing.
2. If you have controller knobs on your MIDI keyboard and have set up the Controllers (Options, Preferences, Controllers) to match your keyboard, you can use these knobs to modify the sound. Notice that the on-screen knob follows the movement of the hardware knob.
3. Try changing the filter type. Click on the selector to the right of the filter name and select one of the 53 different filter types.
4. Adjust the Tone and Presence controls while playing the keyboard to hear your changes.
5. Change the Volume and Pan controls for the MIDI channel you are using. These settings can be adjusted remotely using MIDI controller #7 (volume) and controller #10 (pan).
6. If you want to save the changes, you must set the **Initial Controller Amounts** in the **Preset Globals** page to match the settings you made in the **Multisetup** page, then save the bank.

Create Your Own Custom Bank

It's easy to create your own custom sound banks by simply "dragging and dropping" the presets you want onto the Proteus VX icon in the tree.

► To Create a New Custom Bank

Locate the Presets on your Computer

1. Select **New** from the File menu. This creates a new empty bank. (You can also merge presets into an existing bank if you wish.)
2. Select the **System** Tab. The Desktop icon will appear in the tree.
3. Locate the presets you wish to include in your new bank. These will be located in the "Creative Professional" folder located in "Program Files".

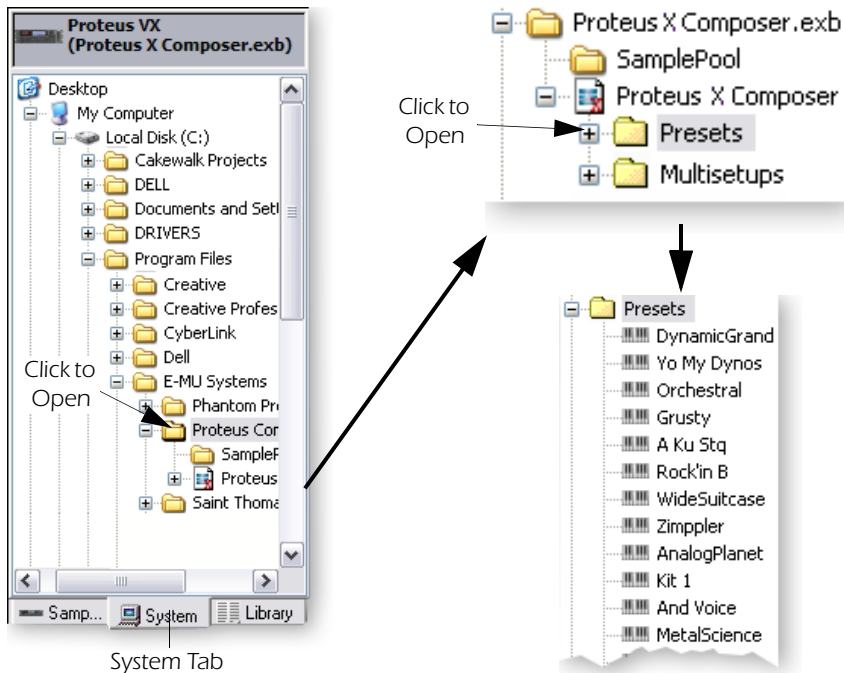

■ Many other great banks of sounds are available from E-MU Systems. Please visit our web page at: <http://www.emu.com>

Audition the Presets

4. After you have located the **Presets** folder, click on the **Proteus VX** icon in the Tree to view the Multisetup page.
5. Find a preset in the Tree or List View and **Right-click** over it. A pop-up menu appears with two options, **A**udition and **M**erge.
6. Select **Audition** (or press "A" on your computer keyboard). Notice that the preset name is now flashing in the Multisetup screen.
7. **Play your MIDI keyboard** to audition the preset from the hard disk.
8. **Right-click** again and select **Stop Audition** (or press "S" on your computer keyboard). The preset name stops flashing in the Multisetup screen.
9. Continue auditioning until you find a preset you like.

■ **Tip:** You can also audition presets from the library.

Merge the Preset

10. When you have found a preset you want to include, **Right-click** over it in the Tree or List View and select **Merge** from the menu (or press "M" on your computer keyboard). The preset is added to the current bank.

■ The List View allows you to select multiple presets to merge.

Another Method of Merging Presets

11. Simply **click** (left mouse button) and **drag the preset** over the **Proteus VX icon** at the top of the tree. The cursor changes to a plus sign as you pass over the icon. Release the mouse button and a pop-up progress bar will inform you that the preset is being loaded.
12. If you change your mind and don't want to merge the preset after all, choose **Undo** from the Edit menu to un-merge the preset.

Continue to Create the Bank

13. Continue to add presets to your new bank.
14. Save the bank when you are satisfied.

► Alternate Method using the Librarian to find Presets

1. Select the **Library** Tab instead of the System Tab in step 3 above.
2. If you haven't done so already, **Update** the Library.
3. Choose presets from the Library, then **drag and drop** them on top of the **Proteus VX icon** at the top of the tree.

Save and Save As

When you choose "Save" or "Save As" from the file menu, the entire bank (except for the samples) is re-written to the hard disk. Since presets don't take up much memory, this operation is fast.

Be sure to rename your bank when using Save As... to save an edited bank, otherwise you may overwrite data you wanted to keep.

Proteus VX Bank Structure

Banks are comprised of two distinct entities which need to be kept in the same folder on your computer hard disk. The **SamplePool** contains the raw sample data used. The **Bank** file contains all the voice, preset and multisample data that makes up the Proteus VX bank.



The Librarian

As your sound library grows so does the problem of managing all your banks and presets. As you've probably already discovered, a single bank can contain literally hundreds of presets.

The Library is accessed by clicking the Library tab at the bottom of the Tree. To use the librarian, you first "Update" from the File menu. This creates a searchable database of all your presets and banks which can be quickly searched.

You can select which drives you wish to add to the catalog or manually "Add Locations" to narrow down the selection range to speed the update process. The Add Location button also allows you to specify network drives to catalog. Only the selected targets are overwritten with new data when the update process is performed.

Unselected targets remain as they were. The "Clear Library" button erases the entire library so you can start from scratch.

► Using the Librarian

Catalog your Disks

1. Select **Update** from the File menu. A popup dialog box appears asking you to select the disks you wish to catalog.



Update Updates the Library with the selected items, leaving non-checked targets intact.

Clear Library Erases Library database.

Add Location Allows you to manually select targets to speed update time or select network drives to catalog.

2. Select any disk drives that contain the banks and presets that were included when you installed the Proteus VX application. Using the **Add Location** button, you can select network drives to add to the Library catalog. The Add Location button also allows you to select specific folders or locations for cataloging.
3. Click the **Update** button to begin cataloging. The display will read: "Updating". This process may take a few minutes depending on how many files need to be cataloged.

■ **Cool Tip:** Categorize multiple Presets:

1. Go to the Tree
2. Click the Presets folder.
3. Select multiple presets.
4. Right-click and choose category.
5. Select category.

Find your Files

4. Select the Library tab at the bottom of the Tree. All Proteus VX Banks and Presets can now be accessed here. This can take a few seconds, especially with large banks.
5. Click on the **Presets** folder to view all the presets on your hard disks.
6. Select a Category of presets using the **Filter by Category** option.
7. Browse through the Bank, and Preset folders to find the sounds you want.
8. **Right-click on a Preset** to Audition the Preset from disk. You must play the keyboard while Auditioning to hear presets.

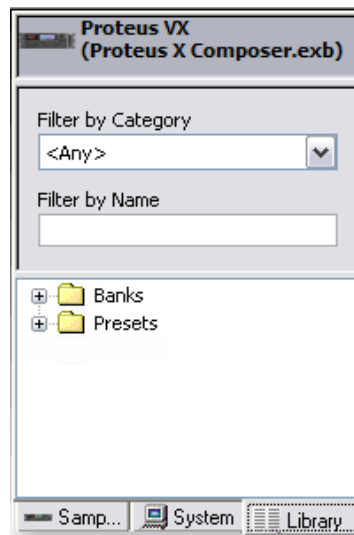

Tip: You can add Category tags to your own presets by Right-clicking on them.

Load your Files

9. To add a file to the bank, **Left-click and Drag** the desired object in the Library over the Proteus VX icon at the top of the tree and release the mouse button. The file is added to the bank.
10. **Or...** Select the object you want from the Library and Right-click. Then select **Merge** to merge the object into the current bank.

3 - Multisetup / Global Controls

The Multisetup

The Multisetup is the top level of the Proteus VX hierarchy and is the place where you choose and assign presets to each of the MIDI channels.

A multisetup assigns a preset, volume, pan position and output routing to each of the 16 MIDI channels. Multisetups can be saved and recalled for use with a particular song or sequence so that all the MIDI channels play the proper preset.

▼ The MIDI Controller settings and Filter Override are not stored with the Multisetup. These settings are stored with each Preset.

► To Select the Current Multisetup:

1. Click on the Proteus VX icon at the top of the Tree. The current multisetup appears.
2. The Single Mode view is shown below. This view is convenient for performing live or when you're only playing one preset at a time.

Single Channel View

The screenshot shows the Proteus VX Single Channel View interface. The interface is divided into several sections:

- Left Panel (Presets):** A list of presets including Dynamic Grand, Yo My Dynos, Orchestral, Grusty, A Tu Ste, Rock'n B, WideSuitcase, Zimpler, AnalogPlanet, Kit 1, And Voice, MetalScience, Silk OBXsaws, Stolen7Away, Movie Brass, Dyna-heim, Jumping, New Age Oohs, Sugar Freak, Clavinetti, Acoustic 1, BreathyTBone, Real Flute, Allin a Pizz, Walky Talk, Filmscore, L.V.'s Worm, Bag O Tricks, Malgoul EP, and Breather.
- Top Panel (Controls):** Includes Preset Select, Multisetup View Tabs, Select All or by Category, Select Category, Channel Select, Bank & Preset Display, MIDI Mode Select, and Aux FX Display Tabs.
- Center Panel (Main Display):** Shows the current preset 'P0000 Dynamic Grand' and 'Keyboard 1'. It includes Volume (127) and Pan (0) controls, and an Output selector set to 'Analog OUT'.
- Right Panel (AUX EFFECT):** Shows the 'Reverb' effect settings, including Dry/Wet, Decay (0.27), Diffusion (0.48), Room Size (0.48), Early Reflections (70.00%), Pre-Delay (5.00 msec), HF Damping (0.33), LF Damping (0.00), Stereo Mode, and Figure Eight.
- Bottom Panel (MIDI CONTROLLERS & MASTER SETTINGS):** Features MIDI controllers (CTRL A-M) and Master Settings including Transpose (+0), Tempo (120.00 BPM), Master Volume, Master Tune & Transpose, and a Limiter (50% RELEASE).
- Bottom Status Bar:** Displays RAM Used (32 MB), CPU & Disk Usage Meters, Samples Playing (0), Current Channel (Ch. 1), Filter Override, and Limiter.

There are two views in the Multisetup page. The **Multisetup View** buttons change the current view.

- **Single**.....Displays the preset for the currently selected MIDI channel.
- **Channels 1-16**..Displays the preset, volume and pan for MIDI channels 1-16.

Changing Presets (from Single View)

Single View is the default view when you first run Proteus VX. This view is convenient for performing live or when you're only playing one preset at a time. All the main parameters for the selected MIDI channel are displayed in Single View and a convenient Category mode allows you to quickly select presets in a certain category. A close-up of the current channel settings is shown below.

◆ Note that Single View only changes the display and does not affect the currently selected MIDI mode (i.e. Omni, Poly or Multi).

Single View Close-up



◆ The Bank/Program Display shows the Bank and Program number you would use to select the preset from a sequencer.

► To Select Presets by Number

1. Click on the **Preset Increment/Decrement** buttons to move up or down the presets by number.
2. Highlight the **Preset Number** field and type in the desired preset number.

■ You can also use the up/down arrow keys on your computer keyboard to inc/dec presets when the preset number field has the cursor.

► To Select Presets by Category

1. Click on the **Select Category** button. The pop-up dialog box at right appears.
2. Select the desired preset category, then press **OK**.
3. Choose **Select By Category** from the Single view screen above.
4. Use the **Increment** or **Decrement** buttons to select presets. Note that only presets of the selected category are selected.

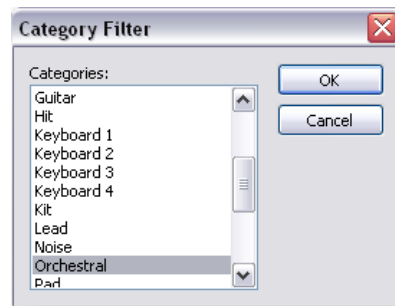

► **Changing the Current MIDI Channel**

The Current MIDI Channel is simply the MIDI channel you are currently working with. To change the current MIDI channel, simply **increment** or **decrement** the channel number using the buttons, or click on the **channel number** and type in the desired number.

16 Channel View

Press the 1-16 Multisetup View button to view 16 channels at once. This mode is useful for sequencing or when playing multiple MIDI channels.

Channel 1-16 View

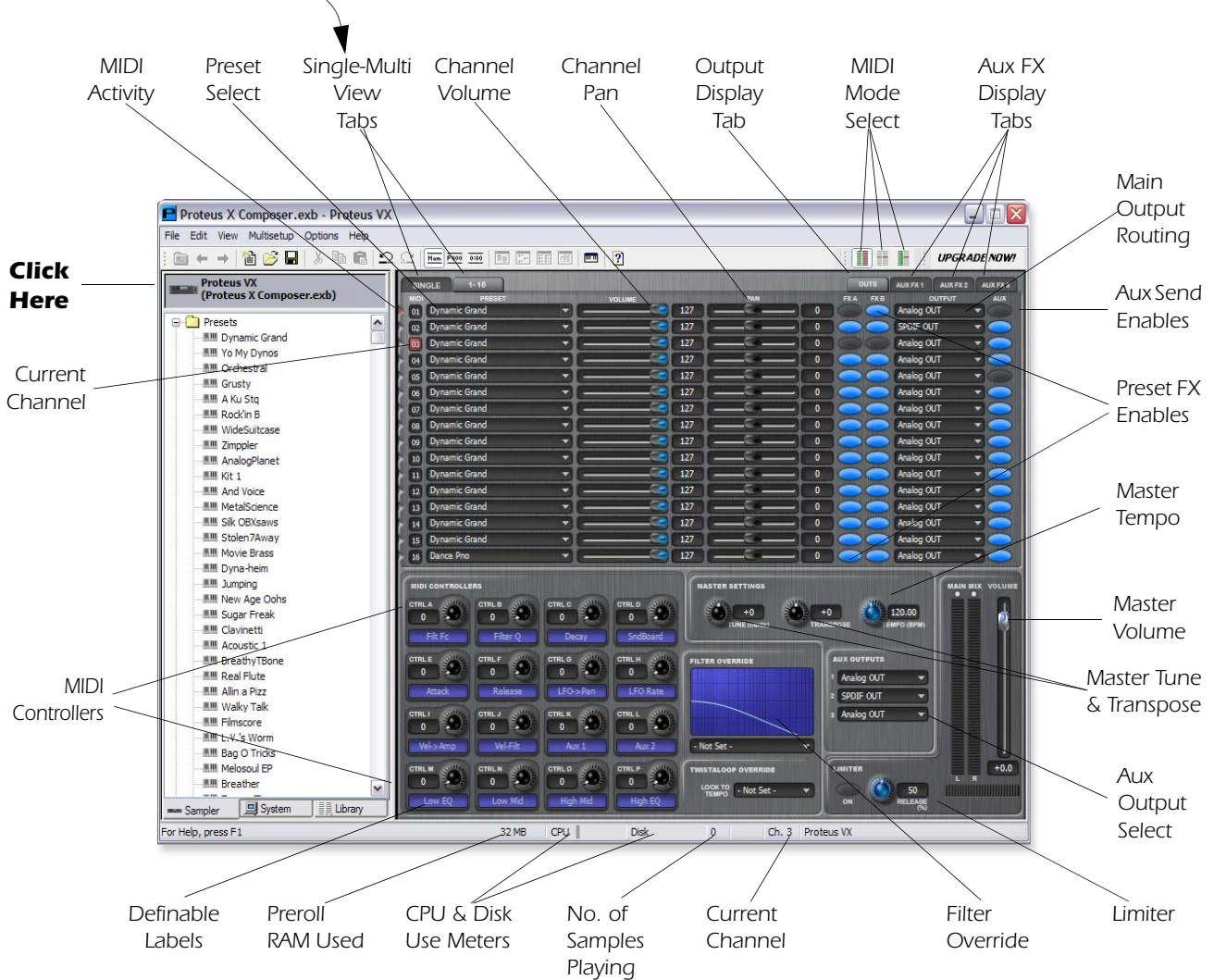

Saving your Multisetup

The current Multisetup is automatically saved when you save your Project in the recording application (Cubase, Sonar, etc.).

- Simply set up the Multisetup the way you want it, or select one from the Tree or List View, then **Save your project**. The Multisetup will be saved along with your song.
- You can also save multisetups with the bank of sounds. [See page 48.](#)

The Current MIDI Channel

Change the current channel by clicking anywhere on the desired horizontal channel strip. The yellow indicator displays the currently selected channel number. The MIDI Controllers change to show the settings of the currently selected MIDI channel.

► To Select a Preset:

1. Click on the **Preset Select** button for the desired MIDI channel. The Select Preset dialog box appears.
2. Click on the presets in the list to audition them. Presets can be viewed by large icon, small icon, by list, or by detailed list. Presets can also be sorted by name, ID, bank/program number, or category when in Detail View mode.
3. To choose a preset, **select** it and **press OK**, or **double-click on the preset** in the list.

► To Select a Preset from the Tree or List View:

1. Set the Current Channel by clicking anywhere on a horizontal channel strip in the Multisetup window. The channel number turns yellow, indicating that this is the current channel.
2. Choose the preset you want in the tree or list view and **Right-Click** on its preset icon.
3. Choose **Select on Current Channel**. The preset is now selected for that channel.
4. You can also select a preset for the current channel by simply clicking the preset's keyboard icon from the tree or list view.

MIDI Channel

Each channel only responds to MIDI data on its particular channel. Use the small keyboard at the bottom of the window to audition presets on the currently selected channel. Select the current channel by clicking anywhere on the desired channel strip. The yellow indicator displays the currently selected channel number.

Preset Assignment

Assign presets to MIDI channels by clicking on the selector button to the right of the preset field. A pop-up dialog box appears with the list of presets in the bank. Select a preset, then click OK to select.

Channel Volume

This control sets the relative volume of the MIDI channel. This is equivalent to MIDI controller #7 (channel volume) and changes made over MIDI will be shown here.

Channel Pan

This control sets the stereo position of the MIDI channel. This is equivalent to MIDI controller #10 (channel pan) and changes made over MIDI will be shown here.

Output Assignment

This control selects the **Main Output** assignment for the MIDI channel. 100% of the stereo output signal is sent to the selected output bus.



The number of outputs available in this field depends on the number of stereo channels you have allocated. By default, you'll only have Bus 1.

- Add **VST Output Buses** in the Proteus VX **Preferences** to increase the number of available outputs.

Output View Button

This button allows you to view the Aux Send On/Off, Main Output Routing, and Preset FXA/FXB Bypass buttons when not in Single Mode. (The button is disabled in Single mode.)

You may want to bypass the Preset Effects on certain channels in order to free up CPU power or to hear the presets dry.

Aux FX View Buttons

The buttons above the TV display select which of the three possible Aux Effect is currently displayed. Note: The Output View button is disabled in Single mode.

Aux Send On/Off

These buttons enable (blue) or disable (grey) the inputs to the Aux Sends for each MIDI channel. These buttons also enable/disable the Aux Outputs for each channel. [See page 43.](#) The Main Output is unaffected by these buttons.

These buttons disable the Aux Sends whether the Aux FX are being used or not. Please refer to the diagram on [page 62](#) to see the exact location of this switch in the signal path.

◆ The Output View button is only available when the 1-16 view is selected. In Single mode you can only control the current channel.

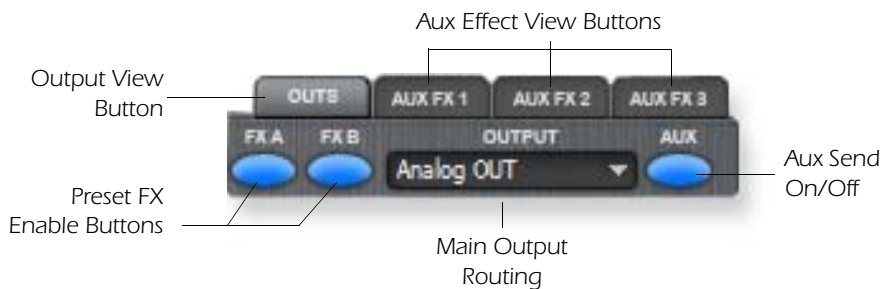

Preset FX Enables

These two rows of buttons marked FXA and FXB, enable or disable the preset effects for each MIDI channel. These work differently than the Aux Send On/Off buttons in that they *bypass* the effects instead of turning them on or off. These buttons are useful to bypass any preset effects which may have been programmed in the preset.

Please refer to [Chapter "5 - Effects" on page 59](#) for detailed information about the output and effects routing.

Select Effect

Click on the Effect Select icon  at the top right corner of the Effects TV screen. A list of available effects drops down. See ["Adding an Aux Effect in the Multisetup" on page 60](#) for complete details on how to add aux effects.

TwistaLoop Override

This three-way switch determines if the beat looping features are locked to Master Tempo. The three modes are as follows:



- **On:** Beats on the channel are locked to the Global Master Tempo. This control overrides the "Sync To Master Clock" setting in the preset.
- **Off:** Beats on the channel are NOT locked to the Global Master Tempo. This control overrides the "Sync To Master Clock" setting in the preset.
- **Not Set:** . . The "Sync To Master Clock" button in the Preset Globals page determines whether or not the Beats are locked to the Global Master Tempo.

Global Controls



Master Volume Control & VU Meter

This is the master volume control for the Proteus VX. This slider controls the output volume of all MIDI channels. The range of this control can be adjusted using the Headroom/Boost control in the Preferences dialog box. [See page 20.](#)

The VU meter indicates the overall output level of the Proteus VX Main Outputs. It serves as a handy indicator to show clipping or to troubleshoot audio output problems.

Tempo Control

This control and associated display sets the master tempo when the Proteus is chosen as the tempo source. Proteus VX contains a global master clock which is used for Tempo-based Envelopes, the Twistalooop features, Tempo-based LFOs, and clock modulation.

IMPORTANT: “External Tempo Source” in the MIDI Preferences dialog must be **OFF** for this control to operate.

When “External Tempo Source” in the preferences dialog box is On, and an external MIDI device or application is generating MIDI clock, the Proteus VX tempo will lock to the MIDI clock tempo.

Master Tune

Master Tune adjusts the overall tuning of all presets so you can tune Proteus VX to other instruments. The master tuning range is ± 1 semitone in one cent steps (1/100th of a semitone). A master tune setting of 0¢ indicates that the Proteus VX is precisely tuned to concert pitch (A=440 Hz).

Master Transpose

The master transpose parameter transposes the key of all presets in semitone intervals. The transpose range is ± 12 semitones (1 octave).

Limiters

When playing the Proteus VX you may sometimes hear digital clipping. This clipping occurs in the digital hardware and is not caused by the Proteus VX, which uses high resolution floating point processing and has tremendous internal headroom.

To avoid the clipping, you could always lower the volume controls, but there’s a better way. The Limiter monitors the signal ahead of the output stage and automatically turns down the volume before clipping can occur.

► To Use the Limiter

1. Press the Enable button, illuminating the button.
2. Set the Release knob to about 30% to start. Release controls how fast the limiter turns the volume back up after reducing it to avoid the clipping peaks.
3. Increase the release time if you hear obvious volume changes (pumping). Reduce the release time for percussive playing.

Aux Outputs

These three output assignments assign the Aux Sends to buses going to the Host application. The Aux Output Assignment section of the Multisetup allows you to assign each of the three Aux Sends to a separate Bus to the Host Application if you so desire.

◆ See Chapter [“5 - Effects” on page 59](#) for complete descriptions of the effects routing.

Important: You must select the number of available buses in the Proteus VX Preferences menu before they become available.

Proteus VX Aux Bus Routing

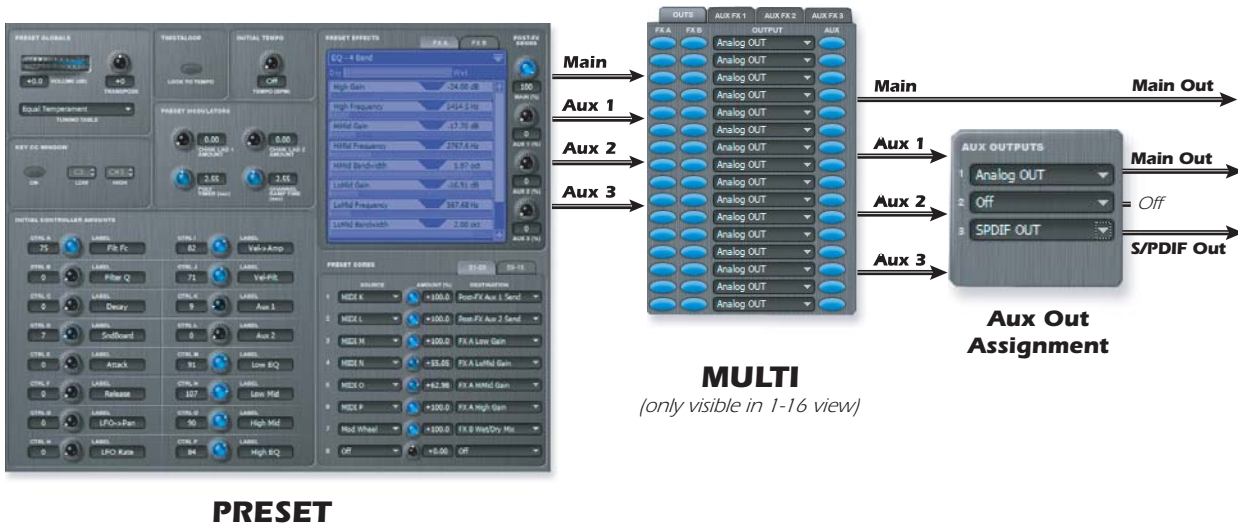

MIDI real-time Controllers & Scribble Strips

Filter Override

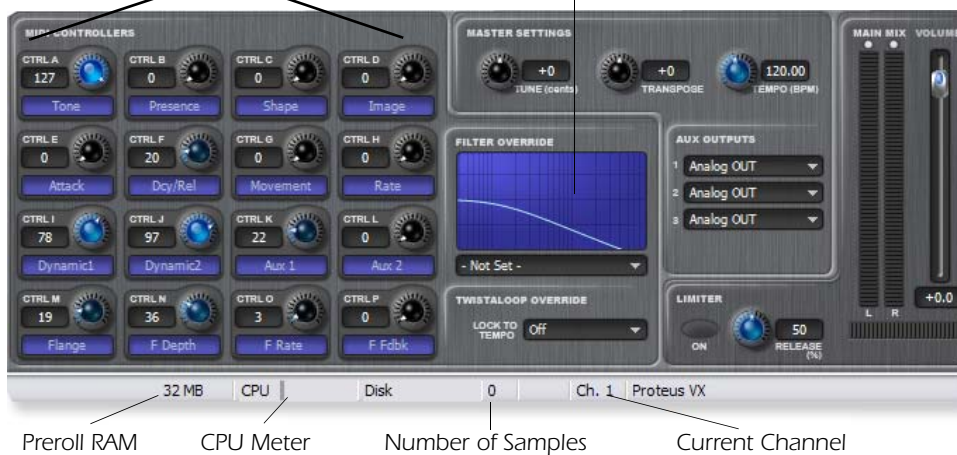

Filter Override

The filter type of the first voice in the preset (on the currently selected channel) is shown in this display. If you change the filter type in this field, ALL the voices in the preset will change to the filter type you select. When the display reads, - **Not Set** - the filters programmed in each voice will be used. The filters may be set differently for each voice.

You can choose from 55 different filter types or choose “No Filter”, which bypasses the filter section.

The frequency response curve of the filter is accurately shown in the display. Frequency is shown on the horizontal axis, with amplitude on the vertical axis.

You will notice an increase in voice count when the filters are bypassed as the filters steal cycles from your computer’s CPU. 12th order filters use more CPU and therefore decrease the maximum voice count.

Filter Descriptions

Filter Name	Order	Type	Description
2-pole Lowpass	02	LPF	Typical OB type low-pass filter with a shallow 12 dB/octave slope.
4-pole Lowpass	04	LPF	4-pole low-pass filter, the standard filter on classic analog synths. 24 dB/octave rolloff.
6-pole Lowpass	06	LPF	6-pole low-pass filter which has a steeper slope than a 4-pole low-pass filter. 36 dB/octave rolloff!
2-pole Highpass	02	HPF	2-pole high-pass filter. 12 dB/octave slope.
4-pole Highpass	04	HPF	Classic 4-pole high-pass filter. Cutoff sweep progressively cuts 4th Order High-pass.
2-pole Bandpass	02	BPF	Band-pass filter with 6 dB/octave rolloff on either side of the passband and Q control.
4-pole Bandpass	04	BPF	Band-pass filter with 12 dB/octave rolloff on either side of the passband and Q control.
Contrary Band pass	06	BPF	A novel band-pass filter where the frequency peaks and dips midway in the frequency range.
SweptEQ 1 octave	06	EQ+	Parametric filter with 24 dB of boost or cut and a one octave bandwidth.
Swept EQ 2->1 octave	06	EQ+	Parametric filter with 24 dB of boost or cut. The bandwidth of the filter is two octaves wide at the low end of the audio spectrum, gradually changing to one octave wide at the upper end.
Swept EQ 3->1 octave	06	EQ+	Parametric filter with 24 dB of boost or cut. The bandwidth of the filter is three octaves wide at the low end of the audio spectrum, gradually changing to one octave wide at the upper end.
Phaser 1	06	PHA	Recreates a comb filter effect typical of phase shifters. Frequency moves position of notches. Q varies the depth of the notches.

Filter Types

- BPF** Band-pass filter
- EQ+** EQ boost filter
- EQ-** EQ cut filter
- FLG** Flanger filter
- HPF** High-pass filter
- LPF** Low-pass filter
- PHA** Phaser filter
- PROG** Programmable
- REZ** Highly Resonant
- SFX** Special Effect
- VOW** Vowel / formant
- WOW** Wah-Wah pedal

Filter Name	Order	Type	Description
Phaser 2	06	PHA	Comb filter with slightly different notch frequency moving the frequency of notches. Q varies the depth of the notches.
FlangerLite	06	FLG	Contains three notches. Frequency moves frequency and spacing of notches. Q increases flanging depth.
Vocal Aah-Ay-Eeh	06	VOW	Vowel formant filter which sweeps from "Ah" sound, through "Ay" sound to "Ee" sound at maximum frequency setting. Q varies the apparent size of the mouth cavity.
Vocal Ooh-Aah	06	VOW	Vowel formant filter which sweeps from "Oo" sound, through "Oh" sound to "Ah" sound at maximum frequency setting. Q varies the apparent size of mouth cavity.
Dual EQ Morph	06	PROG	As programmed in the Voice
Dual EQ + Lowpass Morph	06	PROG	As programmed in the Voice
Dual EQ Morph + Expression	06	PROG	As programmed in the Voice
Peak/Shelf Morph	06	PROG	As programmed in the Voice
Morph Designer	2 - 12	PROG	As programmed in the Voice
Ace of Bass	12	EQ+	Bass-boost to bass-cut morph
MegaSweepz	12	LPF	"Loud" LPF with a hard Q. Tweeters beware!
EarlyRizer	12	LPF	Classic analog sweeping with hot Q and Low-end.
Millennium	12	LPF	Aggressive low-pass filter. Q gives you a variety of spiky tonal peaks.
MeatyGizmo	12	REZ	Filter inverts at mid-Q.
KlubKlassik	12	LPF	Responsive low-pass filter sweep with a wide spectrum of Q sounds
BassBox-303	12	LPF	Pumped up lows with TB-like squelchy Q factor.
FuzziFace	12	DST	Nasty clipped distortion. Q functions as mid-frequency tone control.
DeadRinger	12	REZ	Permanent "Ringy" Q response. Many Q variations.
TB-OrNot-TB	12	EQ+	Great Bassline "Processor."
Ooh-To-Eee	12	VOW	Oooh to Eeee formant morph.
BolandBass	12	EQ+	Constant bass boost with mid-tone Q control.
MultiQVox	12	VOW	Multi-Formant, Map Q To velocity.
TalkingHedz	12	VOW	"Oui" morphing filter. Q adds peaks.
ZoomPeaks	12	REZ	High resonance nasal filter.
DJAlkaline	12	EQ+	Band accentuating filter, Q shifts "ring" frequency.

Filter Name	Order	Type	Description
BassTracer	12	EQ+	Low Q boosts bass. Try sawtooth or square waveform with Q set to 115.
RogueHertz	12	EQ+	Bass with mid-range boost and smooth Q. Sweep cutoff with Q at 127.
RazorBlades	12	EQ-	Cuts a series of frequency bands. Q selects different bands.
RadioCraze	12	EQ-	Band limited for a cheap radio-like EQ
Eeh-To-Aah	12	VOW	"E" to "Ah" formant movement. Q accentuates "peakiness."
UbuOrator	12	VOW	Aah-Uuh vowel with no Q. Raise Q for throaty vocals.
DeepBouche	12	VOW	French vowels! "Ou-Est" vowel at low Q.
FreakShifta	12	PHA	Phasey movement. Try major 6 interval and maximum Q.
CruzPusher	12	PHA	Accentuates harmonics at high Q. Try it with a sawtooth LFO.
AngelzHairz	12	FLG	Smooth sweep flanger. Good with vox waves. e.g. 1094, Q =60
DreamWeava	12	FLG	Directional Flanger. Poles shift down at low Q and up at high Q.
AcidRavage	12	REZ	Great analog Q response. Wide tonal range. Try it with a sawtooth LFO.
BassOMatic	12	REZ	Low boost for basslines. Q goes to distortion at the maximum level.
LucifersQ	12	REZ	Violent mid Q filter! Take care with Q values 40-90.
ToothComb	12	REZ	Highly resonant harmonic peaks shift in unison. Try mid Q.
EarBender	12	WAH	Midway between wah & vowel. Strong mid-boost. Nasty at high Q settings.
KlangKling	12	SFX	Ringing Flange filter. Q "tunes" the ring frequency.

MIDI Controllers & Scribble Strips

Sixteen real-time MIDI Controllers are available to control the preset on the currently selected channel. These controllers are connected to MIDI sources as assigned in the Preferences dialog box ([page 22](#)) and changes made over MIDI will be reflected here.

The scribble strip names and the initial settings of the controller knobs are user programmable in the Preset Globals window. See [page 52](#).

Preroll RAM Used

This display shows how much of your computer's RAM is being used by pre-roll sound data (samples). See [page 18](#).

CPU Meter

This display shows how much of your computer's CPU power is being used by the Proteus VX.

Number of Samples Playing

This display shows you how many samples are currently being played. The maximum number of samples that can be played depends on a variety of factors such as: HD speed, RAM memory speed and CPU speed. See ["Audio Setup" on page 19](#) for more information about performance.

Current Channel

This displays the currently selected MIDI channel. Change the current channel by clicking anywhere on the desired channel strip.

Working with Multisetups

A Multisetup is a “snapshot” of the current Proteus VX settings. Multisetups store the preset, volume, pan position, and output bus routings for 16 MIDI channels along with the Global Tempo and the three Aux Send destinations.

Saving FX & Multisetups

It is important to realize what data is stored in a multisetup when saving banks. In addition to Volume, Pan, and Preset choices for each channel, the FX Aux 1, Aux 2, and Aux 3 are stored with the multisetup. The send level for each preset to each Aux bus is stored in the preset data. **Remember to save the bank whenever you have made changes that you want to keep.**

VSTi Multisetups

A multisetup for your VSTi is stored in your Cubase project and will be loaded when the project is opened. This multisetup overrides whatever default multisetup may have been saved if the bank was opened in Proteus VX standalone mode. If you wish to store extra multisetups you may do by using the Multisetup menu on the toolbar.

► To Save the Current Multisetup

1. Set up all the multisetup parameters the way you want them.
2. Select **Save** from the Multisetup window on the toolbar.
3. Choose a **name and number** for the multisetup. Changing the number allows you to place the Multisetup anywhere you want in the list.
4. Press **OK** to save the Multisetup.
5. **Save the Bank**, otherwise nothing will be saved.

► To Restore a Multisetup

1. Open the multisetup folder in the Tree. Any multisetups contained in the bank will be listed below the folder.
2. **Left-click** on the desired multisetup icon in the Tree or and **drag it** over the **Proteus VX icon** above the Tree. This multisetup will be restored.
3. Alternate Method - **Right-click** over the Multisetup icon in the Tree and choose **Load**.

► To Export the Multisetup as a New Bank

This feature lets you save only the presets and samples you need as a new bank.

1. Set up all the multisetup parameters the way you want them.
2. Select **Export** from the Multisetup window on the toolbar. The popup “Save As” dialog box appears prompting you for the save location.
3. Choose the location for your new bank and click **Save** to save the bank, or click **Cancel** to cancel the operation.

► To Rename a Multisetup

1. **Open** the multisetup folder in the Tree. Any multisetups contained in the bank will be listed below the folder.
2. **Right-click** on the desired multisetup icon in the Tree (or list view), then select **Rename** from the pop-up menu.
3. Type in a new name for the multisetup.

► **To Delete a Multisetup**

1. Open the multisetup folder in the Tree. Any multisetups contained in the bank will be listed below the folder.
2. **Right-click** on the desired multisetup icon in the Tree (or list view), then select **Delete** from the pop-up menu.
3. The Multisetup will be deleted.

► **To Duplicate a Multisetup**

1. Open the multisetup folder in the Tree. Any multisetups contained in the bank will be listed below the folder.
2. **Right-click** on the desired multisetup icon in the tree, then select **Duplicate** from the pop-up menu.
3. The Multisetup will be duplicated renamed "Copy of...XX" and placed in the first empty Multisetup location.

► **To Rearrange the Order of Multisetups**

1. Click once on the multisetup folder in the tree. The list of multisetups appears.
2. Select **Details View** from the view options in the toolbar and change the ID number.
3. If you try to save a Multisetup with a number that is already used, a popup dialog box will appear asking you if you want to use the next available ID number or enter a new ID.

4 - Preset Editor

The Preset Editor allows you to edit the tuning, keyboard tuning table, initial controller amounts, preset level effects and the preset patchcords.

All the Preset Editor parameters are saved when you save the bank.

► To Select a Preset for Editing:

1. Choose the preset you want in the tree and Left-Click on its preset icon.
2. The Preset Editor page appears

► Alternate Selection Method:

1. Simply double-click on the preset name in the Multisetup View (either in Single or Multi view).

► To Edit a Preset:

1. Adjust the **Initial Controller Amounts** and note their effect on the sound. These are the main synthesizer control parameters and can produce dramatic changes in the sound.

Controllers K & L are normally used to control the global effects amounts.

Controllers M-P are usually connected to various controls on the Preset FX.

2. Next try changing the **Preset FX** and the parameters associated with each effect.
3. The **Preset Cords** can also be edited. These cords are quite useful for controlling the Preset FX via MIDI controllers. The available FX parameters depend on which Preset FX you have selected.
4. The **Volume**, **Transpose** and the **Tuning Table** can be edited and saved. Try out some of the different tuning tables.

- The **Poly Timer** and **Channel Ramp** are NOT used in any of the Proteus VX Composer presets and so these controls have no effect on the sound.
- The **Channel Lags** are used on several of the organ presets. Look at the Preset Cord routings to find out which ones.

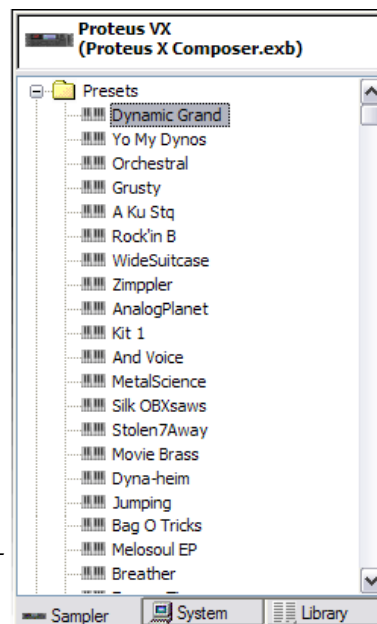

▼ Adding Preset Effects uses CPU cycles. If a preset is used by multiple MIDI channels and you add Preset FX, the CPU penalty is multiplied for each channel that uses the preset.

Preset Globals

These parameters affect the entire preset and are saved with the bank.



Transpose & Volume

Transpose works by shifting the keyboard position. The actual samples are not returned. In other words, if you have the same sound on each key, such as a piano, the piano will change key when you transpose. On the other hand, if you have a different drum assigned to each key, changing transpose will shift the position of the drums on the keyboard.

The volume control allows you to adjust the volume for the entire preset. This control is variable from -96 dB (off) to +10 dB.

Initial Controllers A-P

These set the initial value of MIDI controllers A-P for the preset. As soon as a MIDI controller is moved, it jumps immediately from this initial setting to the new setting of the control. The controllers A-P are assigned to MIDI continuous controller numbers in the Preferences dialog box.

Controllers A-P can be adjusted via MIDI or by turning the controller knob in the Multisetup.

The Label fields to the left of the initial controller knobs are user definable. These labels or "Scribble Strips" also appear in the Multisetup screen to show the function of the real-time controller knobs.

See ["MIDI Channels & Real-time Controls" on page 117](#) for additional information about Controllers A-P.

- Changing the initial controller settings is an easy way to customize a preset. Simply change the knobs and save the bank.

Capture MIDI Controllers

You can capture the state of all your MIDI input device's MIDI controllers, and place the settings in the Initial Controllers section of the Preset. Essentially, this allows you to capture the Multisetup's MIDI controller state, and store it in the preset.

► To Capture MIDI Controllers

1. Make any desired changes to any MIDI controllers on your MIDI input device, or in the Multisetup window.
2. Go to the Preset Globals window for the preset you want to apply your current MIDI state.
3. From the **Preset** menu, select **Capture MIDI Controllers**.
4. Notice that the initial controllers now reflect the state of your MIDI controllers. To keep these settings, you can save the Preset.

TwistaLoop Lock To Tempo

This control locks all analyzed beats in the preset to the global master tempo. When this function is on, all beats in the preset will lock to the master tempo unless "TwistaLoop Override" ([page 41](#)) is turned off.

This button works in combination with "TwistaLoop Override." When TwistaLoop Override is "Not Set," this button determines whether beats sync to the master tempo for the preset. When TwistaLoop Override is set to On or Off for the MIDI channel, this button has no effect. These two controls allow you to set the state of "Sync to Master Clock" by MIDI channel (TwistaLoop Override) or by Preset (this button).



Initial Tempo

This feature allows the master tempo to be programmed from presets that use tempo-based envelopes, LFOs or TwistaLoop.

The Initial Tempo works in combination with the "Preset Tempo Channel" option in the Preferences menu, which allows one specific MIDI channel to control the master tempo.

When the Initial Tempo is set to a tempo on the defined Preset Tempo Channel, the master tempo will follow this tempo setting when the preset is selected.



► To Set the Master Tempo from a Preset:

1. Turn **Preset Tempo Channel** on and set it to the desired MIDI control channel. (Options, Preferences, MIDI) *"External Tempo Source" must be turned off.*
2. Set the **Initial Tempo** (Preset Globals) to the desired tempo.
3. Turn on **TwistaLoop - Lock To Tempo** (Preset Globals) if you are using TwistaLoop.
4. Select the preset on the assigned preset tempo channel.

Tuning Tables

In addition to the standard equally divided octave tuning, Proteus VX contains fifteen factory-programmed tuning tables. The Keyboard Tuning parameter selects which tuning is used by the current preset.

The factory keyboard tuning tables are described in the following table.

Tuning Tables	Description
Equal Temperament	Standard Western tuning 12 equally spaced notes per octave.
Just C	Just intonation. Based on small interval ratios. Sweet and pure, non-beating intervals.
Vallotti	Valotti & Young non-equal temperament. Similar to 12 tone equal temperament. Each key has a different character for a given scale.
19-Tone	19 tone equal temperament. 19 notes per octave. Difficult to play, but works well with a sequencer.
Gamelan	5 tone Slendro and 7 tone Pelog. (Javanese.) Pelog are white keys, Slendro are black keys. Exotic tunings of Gamelan flavor.
Just C2	Allows you to play the following chords in the key of C: C, E, F, G, A, B, C#m, D#m, Em, F#m, G#m, Am, Bm
Just C-minor	Allows you to play the following chords in the key of C: C, E, F, G, A, B, Em, Am, Bm, C#m, D#m, G#m
Just C3	Allows you to play the following chords in the key of C: C, D, F, Bb, C#m, Dm, Em, F#m, G#m, Am
Werkmeister III	A "well" temperament developed in the 17th century. Although you can play in all keys, each key sounds slightly different.
Kirnberger	Another well temperament developed by Johann Philipp Kirnberger where no pitch is more than 12 cents off from equal temperament.
Scarlatti	A variant of Meantone tuning which was used from the 15th to 18th centuries.
Repeating Octave	Middle C octave is repeated up and down the keyboard. Link with a preset in equal temperament to form unusual inversions up and down the keyboard.
al-Farabi 12	A twelve-note reduction of an Arabic/Middle Eastern tuning system. The following scales are useful: Diatonic: C Eb G G# A A# B c Zalzal: C Eb Gb G# A A# B c Persian: C Eb F G# A A# B c
22-Tone	22 tone equal temperament. Good for minor harmonies.
24-Tone	24 tone equal temperament. These notes are quarter steps apart.
36-Tone	26 tone equal temperament. Difficult to play, but even better for minor harmonies.

The Just C Tuning Tables

Well Tempered and Just were standard keyboard tunings up until the 20th-century when the current "equal tempered" scale became prevalent. In an equal tempered scale, the octave is equally divided into 12 parts. In Just or Well Tempered scales, the 12 notes are separately tuned to produce pure chords. However, in Just tunings you are limited to playing certain chords and if you play the wrong chord it may sound terrible!

Tuning tables can be changed as you play using a program change (create several presets with the same sound and different tuning tables) or using a continuous controller (link 2 presets and crossfade between them using a controller).

The Just C2, Just C min, Just C3 Tuning Tables

Fully explaining the mysteries of just intonation is beyond the scope of this manual, but the subject is covered exhaustively in Hermann Helmholtz's [On the Sensations of Tone](#), available at most libraries and bookstores.

The four just intonation tables are called Just C2, Just C3, and Just C Minor. Try playing in the key of C/Cm using each table. You'll quickly discover both the wonders and the frustrations of just intonation! In Just C, for example, you'll find that the chords C, Em, F, G, and Am sound beautiful. If you hold one of these chords, you'll hear no "beating". After playing for a few minutes, switch back to Equal Temperament for a rude awakening!

At this point you might wonder why anyone would use Equal Temperament to begin with. For the answer to that question, play a D, Dmi, or Bb chord! The intervallic ratios that make the C & G chords sound so pure make the D chord sound horribly out of tune. That's why we had to include Just C3. In this tuning, D, Dmi and Bb sound in tune, but the G chord will sound wrong.

Each of the 4 tables allows you to play a different group of common chords in just intonation. Sadly, there is no single 12 note tuning that will allow all of the common chords to be in tune, and of course that's why they invented the equal temperament tuning system that we use today.

Just C

Play these chords: C, E, F, G, A, Cm, C#m, Em, F#m, Gm, Am

Just C2

Play these chords: C, E, F, G, A, B, C#m, D#m, Em, G#m, Am, Bm

Just C minor

Play these chords: C, D^b, D, E^b, G, A^b, Cm, Em, Fm, Gm

Just C3

Play these chords: C, D, F, B^b, C#m, Dm, Em, F#m, G#m, Am

Preset Modulators

The Preset Modulators are special class of modulation sources in that they originate at the Preset Level, but their output is used in the Voice PatchCords. These are the preset modulation sources.

Note: The **Poly Ramp** and **Channel Ramp** are advanced programming functions which are not used in any of the Proteus VX Composer presets and therefore will have no effect if you adjust them. The **Channel Lags** are used on several of the organ presets. Look for the Preset Cord routing to find out which ones.

Preset Modulator	Typical Uses
Preset FX Controls	Control Preset FX parameters such as delay time, reverb decay, etc.
Post-FX Aux Sends	Used to control effects amounts.
Channel Lags 1 & 2	"Leslie" speaker effects. Switch slowly increases/decreases LFO speed.
Poly Ramp (Timer)	Controlling key-up layer volume based on the time a key is held.
Channel Ramp	Ramps on First Note only. Used for "Hammond" style organ percussion.

Templates

For each different module in the Preset Globals window, you can save a library of your favorite settings. These Templates make it easy to create your own customized voices and presets. Templates are saved as an XML file within the Proteus VX application directory so they're always available for use

Channel Lag 1 & 2 Rate

Like the Layer Lag processors, the Channel Lag slows down rapid changes in the input signal. The output “lags” behind the input at a pre-programmed rate.

Unlike the layer level lag processors, the *Channel Lags 1 & 2* take effect as soon as the preset is selected. In contrast, the Voice level lag processors begin acting only after a keyboard key has been depressed. The Channel Lag also has a *Lag Amount* input which controls the lag time. Positive lag amounts increase the lag time. A MIDI controller is commonly used to control lag amount.

The Channel Lags could be used to slowly increase or decrease the speed of an LFO which in turn controls some other effect, perhaps left/right panning, pitch, or the filter. When a MIDI footswitch is used as the input, the lag acts to slow down the instantaneous change of the switch. The slowly changing output value can then be routed using a patchcord to crossfade between voices or change the speed of an LFO.

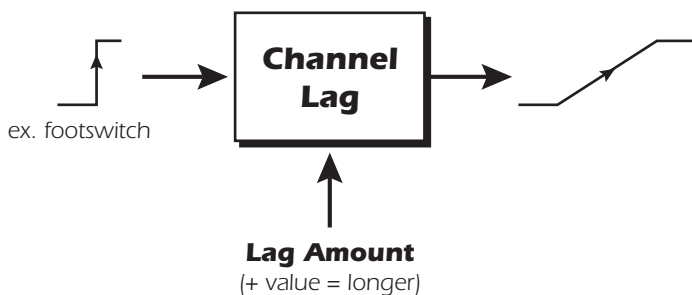

Poly Key Timer

This processor starts a timer which begins counting down whenever a key is pressed and stops when the key is released. The value of this timer can be used on any voices assigned to the key after the key release. The Poly Key Timer is a special modulation source controlled by the key and not the voice.

Poly Key Timer can be used to control the volume of a Release Layer in order to reduce its volume the longer a key is held. This control is commonly used on grand piano presets to lower the pedal damper volume the longer the keys are held.

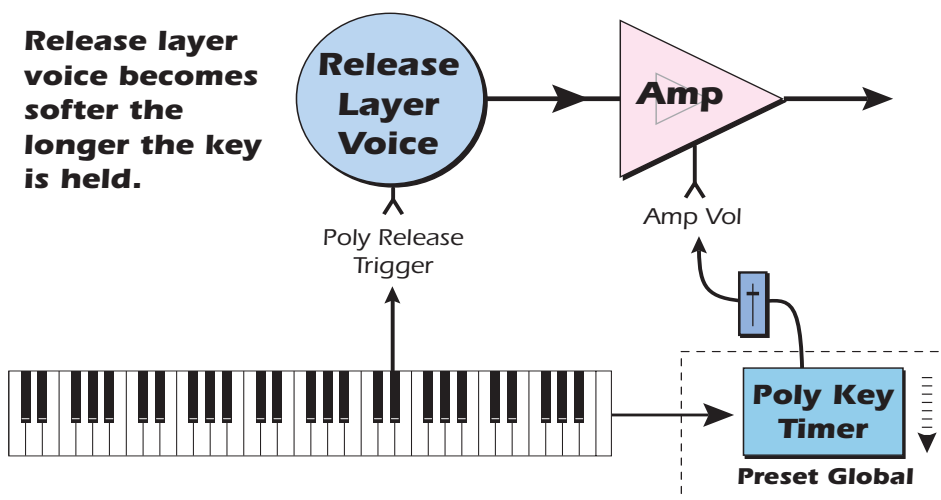

Note-On - Poly Key Timer begins counting down.

Note-Off - Poly Key Timer stops counting and outputs value.

Channel Ramp

This processor generates a single negative going slope whenever the **first** key is depressed on the MIDI channel. This preset level processor was originally designed to simulate the percussion key click on Hammond organs, but you may find other uses.

The Channel Ramp instantly resets when all notes have been released and the next *first key* on the MIDI channel is pressed. The value of the ramp rate sets the increment. Large values produce fast ramps and small values produce slow ramps.

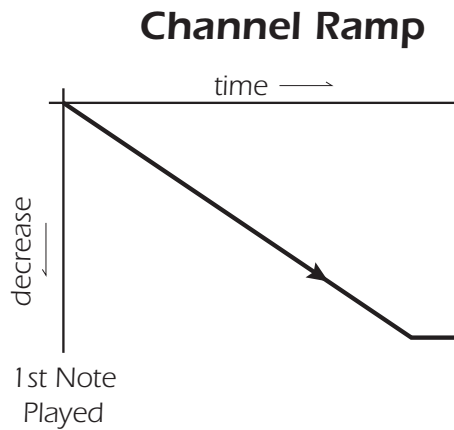

To use the Channel Ramp as a first-note decay envelope, patch the Channel Ramp out to Amp Volume and set the Amp Envelope for a fast attack and 100% sustain and short release.

Preset PatchCords

Preset PatchCords give you real-time control of the Preset Modulators. There are 8 Preset PatchCords per preset with a source, a destination and an amount control. The amount can be set from -100 to +100.

Modulation Sources	Modulation Destinations
Off	Off
Pitch Wheel	Channel Lag 1 In
Mod Wheel (Modulation Wheel)	Channel Lag 1 Amount
Pressure (Channel Pressure)	Channel Lag 2 In
Pedal	Channel Lag 2 Amount
MIDI Volume (Controller 7)	Channel Ramp Rate
MIDI Pan (Controller 10)	Post-FX Main Send
Expression (Controller 11)	Post-FX Aux 1 Send
MIDI A-P	Post-FX Aux 2 Send
Footswitch 1	Post-FX Aux 3 Send
Flip-Flop Footswitch 1 (Fswitch 1 FF)	FX A Mod 1
Footswitch 2	FX A Mod 2
Flip-Flop Footswitch 2 (Fswitch 2 FF)	FX A Mod 3
Thumbswitch	FX A Mod 4
Flip-Flop Thumbswitch (Tswitch FF)	FX B Mod 1
DC Offset	FX B Mod 2
Channel Lag 1 & 2	FX B Mod 3
Channel Ramp	FX B Mod 4

5 - Effects

Overview

In addition to the hardware-based effects of PatchMix DSP, Proteus VX offers software effects processors and a powerful effects routing scheme. The E-MU engineers have created a complete collection of top quality effects using 32-bit floating point precision for pristine sound quality. In addition, the effects algorithms have been designed for low CPU usage.

The Proteus VX effect routing architecture is extremely flexible. Effects can be included as part of the preset or multisetup or both. Preset FX and Aux FX both use the same effects algorithms.

- **Multisetup (Aux) Effects** are designed to be used for your main effects such as reverb or delay. Aux effects can be applied to any or all of the 16 MIDI channels.
- **Preset Effects** are used when you want an effect to be included as part of a certain preset. For example, you might want to add chorus to a string pad or distortion to a guitar sound.

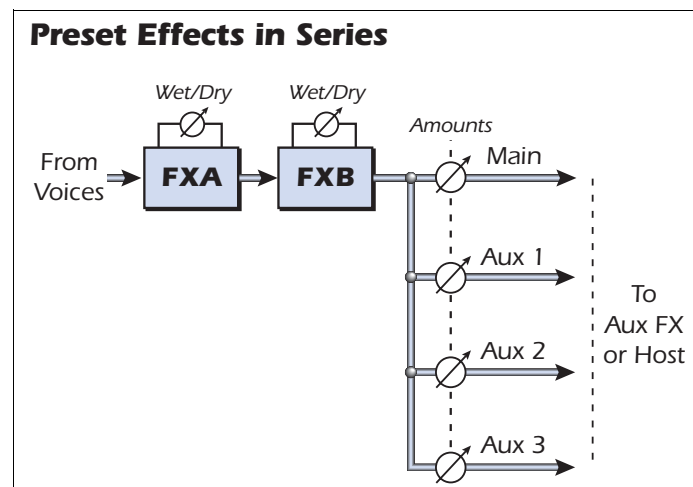
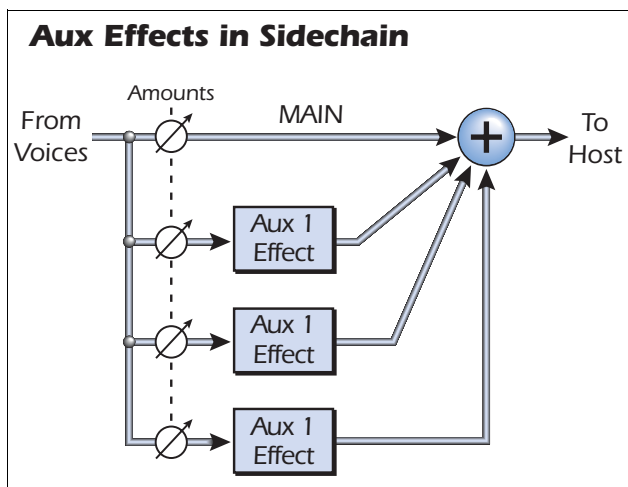

Each effect has a number of user-adjustable parameters and a wet/dry mix control. See [page 22](#) to learn how to use controllers to modulate various effects parameters in real-time.

Programming Effects

Adding an Aux Effect in the Multisetup

Some banks (Proteus X Composer, for example) are already programmed to use Proteus VX soft effects. These instructions explain how to add Aux Effects to a Proteus VX bank which does not already have soft effects programmed.

The Aux Effects are designed to be used as sidechain effects applied on all presets in the bank. See the diagram on [page 62](#) for a complete description of the effects routing.

► How to Add an Aux Effect

1. Select the Multisetup Page by clicking the Proteus VX icon at the top of the tree.
2. Locate the Aux Outputs section in the lower right part of the window and make sure all the Aux Outputs are set to Bus 1 as shown below. (This is done so all the outputs go to the same place.)

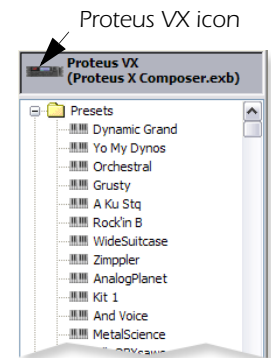

3. Click on the Aux 1 button at the top right of the screen if it's not already selected. The Aux 1 effect appears in the TV screen.
4. Click on the Effect Select Icon  at the top right corner of the Effects TV screen. A list of available effects drops down.

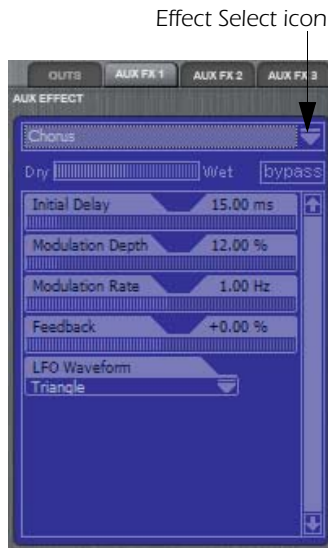

5. Select one of the Effects from the list.
6. Turn up the FXA knob in the MIDI controllers section to hear the effect. (FXA is located on Controller N.)
7. Change the effect parameters to suit your own taste, or change the entire effect for that matter. Keep in mind that the changes you make will affect ALL the presets in the bank.
8. Save the bank if you want to keep your changes.

► How to Temporarily Disable the Aux Effects

You might want to turn off the Aux effects to free up CPU or just to hear the dry mix.

1. Select the **Multisetup Page** by clicking the Proteus VX icon at the top of the tree.
2. Click on the **01-16 Button** to select Multi-view mode.
3. Click on the **OUTS** button near the top right part of the screen. The screen shown at the right appears.
4. The row of buttons marked **AUX** disable the Aux outputs for each channel.
5. **Turn the buttons off (grey)** for the channels on which you don't want effects.

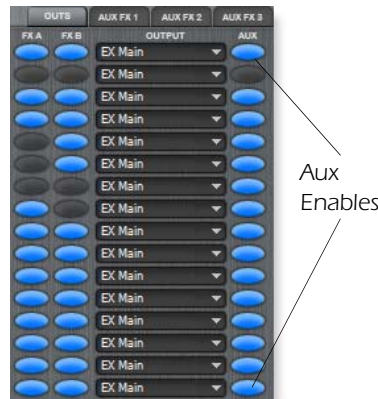



◆ The Aux buttons turn all three Aux buses On or Off.

Adding an Effect to a Preset

Suppose you have a nice string sound, but you want to make it really thick and lush. The obvious solution is to add a chorus. Since you only want the chorus to affect the string sound, you'll use a preset effect.

► How to Add a Preset Effect

1. Select the preset you want in the tree by clicking on the keyboard  icon. The Preset Global page appears.
2. Click on the **Effect Select Icon**  at the top right corner of the Effects TV screen. A list of available effects drops down.
3. Select **Chorus** (or whatever effect you wish) from the list. The Effect name is now listed above the TV screen and the effect parameters are shown in the TV screen.
4. **Play the keyboard.** You should now hear the selected effect as part of your sound. If you don't hear effects, make sure the FXA & FXB enable buttons are on for the MIDI channel you are using. [See page 62.](#)
5. Adjust the **Wet/Dry mix** to control the effect amount.
6. Adjust the effect parameters until you find the sound you want or select a Template.
7. **Save the bank** if you want to keep your changes.

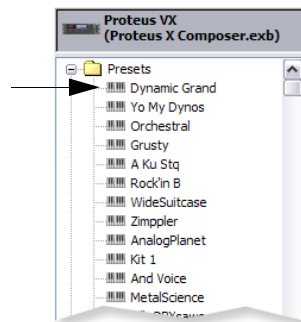

▼ **Caution:** If a preset with effects is used on more than one MIDI channel, the CPU penalty multiplies each time the preset is used.

► **How to Temporarily Disable a Preset Effect**

1. Select the **Multisetup Page** by clicking the Proteus VX icon at the top of the tree.
2. Click on the **01-16 Button** to select Multi-view mode.
3. Click on the **OUTS** button on the top left of the screen. The screen shown at the right appears:
4. The two rows of buttons marked **FXA** and **FXB** enable or disable the preset effects for each channel.
5. **Turn the buttons off (grey)** for the channels you are using if you don't want to use the effects.

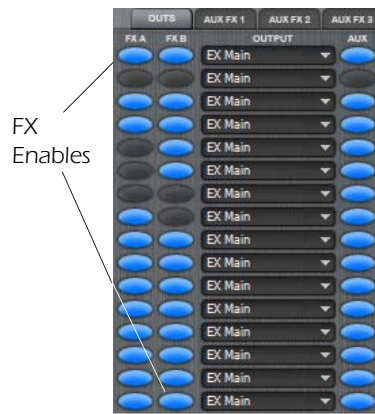

Block Diagram of the Effects Routing

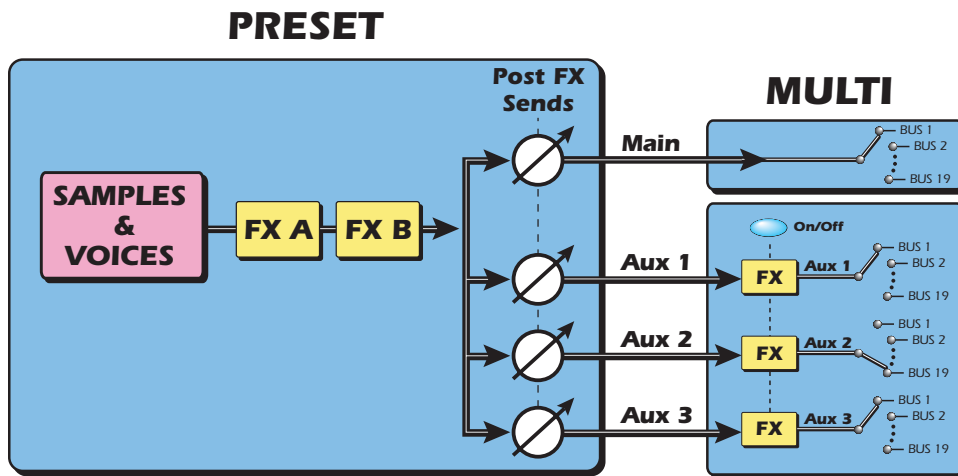

Two effects can be assigned per Preset. Three effects can be assigned per Multisetup.

FX Routing

Make sure that you are thoroughly familiar with the architecture of Proteus VX, before delving into the effects section and it will make a lot more sense. Study the effect routing diagrams below and the preceding page. The effects architecture of the Proteus VX is very flexible and allows for a variety of different signal routing schemes.

Block Diagram of the Effects Screens

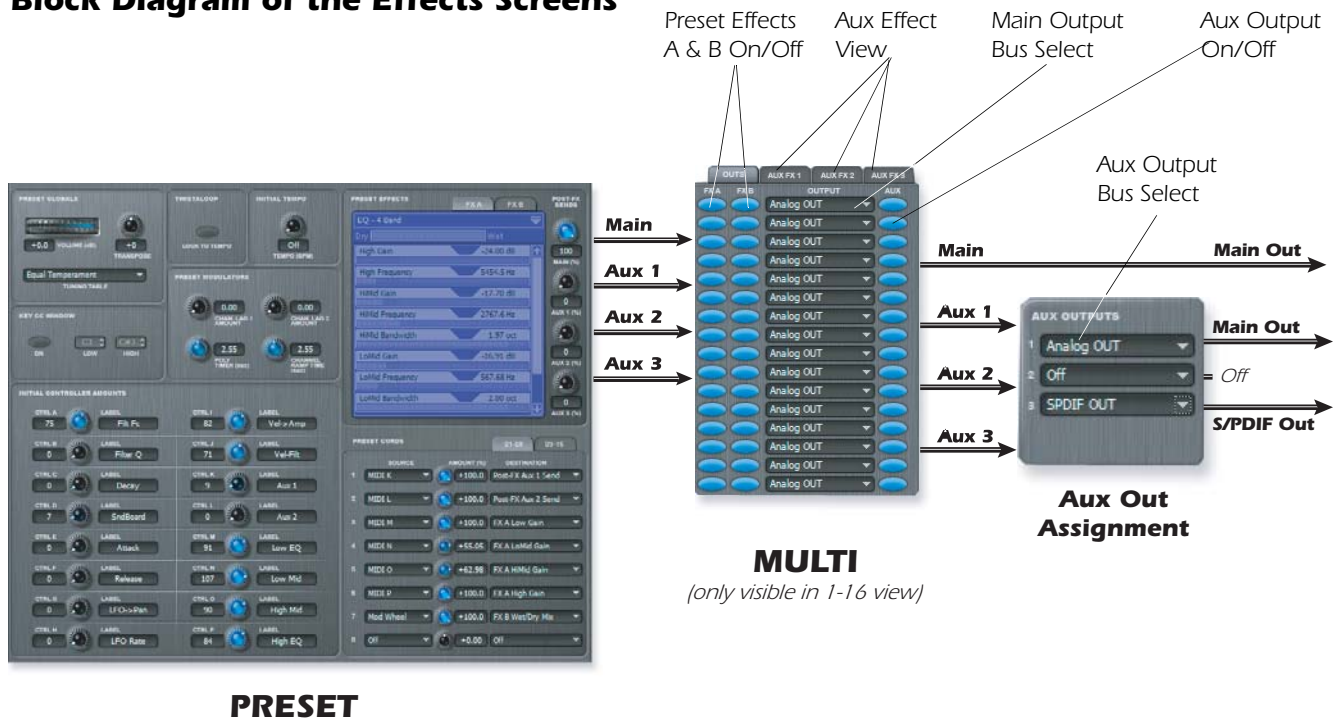

This diagram shows the effects routing using the actual Proteus VX screens in the Preset and Multisetup. The Main output and the Aux 1 outputs are both routed to the Main Output and will be combined in the Host application.

Preset - Main Output	Adjusts the amount of Preset Effect signal that will be sent to the Main Output.
Preset - Aux Outputs 1-3	Adjusts the amount of Preset Effect signal that will be sent to the Aux 1-3 buses.
Multi - Effects A & B On/Off	These buttons enable or disable the Preset A & B effects for each MIDI channel.
Multi - Aux Effect View	These buttons let you see the Main output screen or the Aux 1-3 effect screens.
Multi - Main Output Bus	This field allows you to select the channel pair for the Main Output. (Bus outputs appear in the list only after they have been created in Proteus VX Preferences.)
Multi - Aux Output On/Off	This button turns the Aux outputs on or off for each MIDI channel. In the factory presets, this button effectively enables or disables the global effects.
Multi - Aux Output Bus	This field allows you to select the channel pair for Aux Outputs 1-3. (VSTi Bus outputs appear in the list only after they have been created in Proteus VX Preferences.)

You can place effects in two places:

- **Multisetup** -----Effects placed in the Multisetup (Aux 1, Aux 2 or Aux 3) can be used by all Presets in the Bank.
- **Preset** ----- Effects placed in the Preset (FXA or FXB) are used by one specific Preset.

▼ If a Preset containing an effect is used by more than one MIDI channel, more CPU resources are used.

Effects Overhead

Each effect you select, whether it is located in a Preset or in the Multisetup, uses a percentage of your computer's CPU. Extensive use of effects in every preset can easily bog down your computer. Effects begin running (and using CPU) as soon as they are selected.

Typical Effects Usage

Because the software effects use precious CPU resources, you will generally use Aux effects in the Multisetup for your main effects, since these can be shared by all presets in the bank. You can still use Preset Effects as needed, keeping in mind that the more software effects you use, the fewer CPU resources will be available for polyphony, recording and other tasks.

VSTi Bus Outputs

Bus outputs (Bus 1-19) appear in the list only after they have been created in the Proteus VX Preferences dialog.

Main Output Window

The Main Output window is accessed by clicking the **Outs** button. (This option is not available in “Single” mode.) This one window allows you to set the Host Application Bus routing of the Main Output, enable the Preset Effects, and enable the Aux Outputs for each MIDI channel. This window is extremely handy for turning all your effects on or off.

The **Preset Effect On/Off** buttons are used to temporarily disable the selected A or B effect while passing the signal. These controls allow you to hear each preset with or without effects or to turn off all Preset Effects in order to gauge the CPU load incurred by the Preset Effects.

The **Aux Output On/Off** buttons work differently than the Preset Effect On/Off buttons and *completely* turn off the three Aux Sends for the selected channel. When using the factory presets, the Aux Output buttons are used to enable or disable the Aux Effects (because all outputs are connected to Bus 1. If you were using the Aux buses to send signals to other Buses, the Aux button could be used to turn these outputs on or off.

Main Output Window

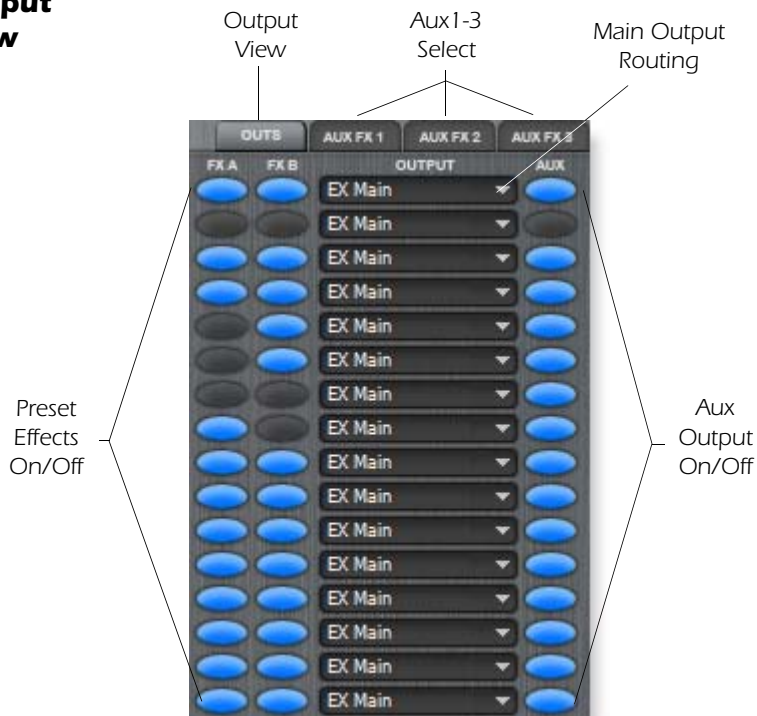

Output View	Selects the Main Output Window. (Note: This button is disabled in “Single” mode.)
Aux 1-3 Select	Select between Aux 1, Aux 2, or Aux 3 FX in the TV view.
Preset Effects On/Off	Turns the Preset A or B effects On or Off for each MIDI channel and passes the signal through.
Main Output Routing	Selects the Bus number for the Main Output. See tip ->
Aux Output On/Off	Turns the Aux Outputs On or Off for the selected channel. This turns all three Aux Outputs Off, rather than bypassing the effects. (Functions as an FX Bypass when the Proteus X Composer bank is used. See page 66.)

■ The number of VSTi buses must be defined in the Proteus VX **Preferences** before they appear in this list.

Proteus X Composer FX Template

This is the effects architecture we have chosen to use for the Proteus VX Composer bank. Preset effects and global effects can be used simultaneously and you can use Cubase LE or PatchMix DSP hardware effects by simply changing the Aux Output routing.

The main effects are located in the **Multisetup** so that they can be shared by all presets. This is the standard sidechain effects routing scheme found on all mixing boards. **Aux 1 = Reverb** and **Aux 2 = BPM Delay**. MIDI controller K controls Reverb amount and MIDI controller L controls Delay amount through the Preset PatchCords.

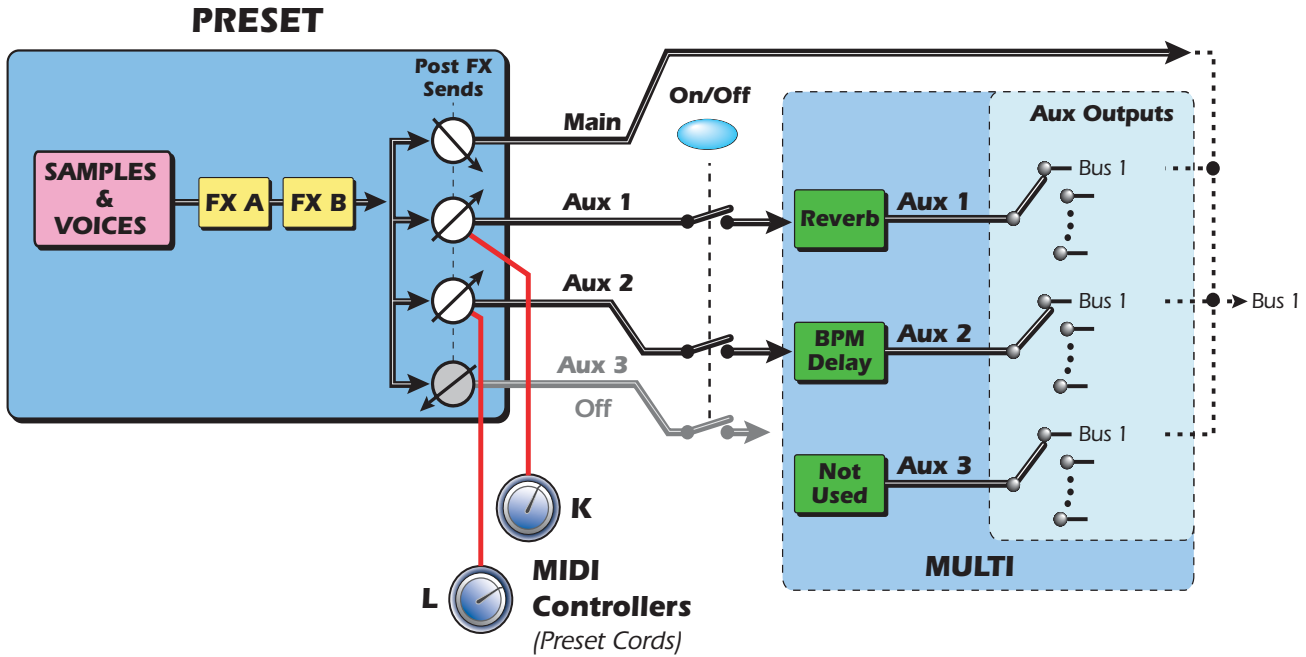

MIDI Controllers M, N, O, and P control various parameters of the Preset FX. You can change the destinations of these controls using the Preset PatchCords. See [“Preset FX Modulation Parameters” on page 69.](#)



Controllers K & L
 Control Aux FX Amounts
Aux 1 = Reverb
Aux 2 = Delay

Controllers M-P
 Control Preset Effect Parameters
 (These are custom programmed for each preset.)

Aux FX Screen

All effects have a wet/dry mix parameter to control the ratio of effected-to-plain signal, which is stored with the FX preset. The effect parameters vary with the type of effect.

Generally, when using the Aux Effects, the wet/dry mix in the effect should be set to 100% wet since the Aux Send amount controls how much effect will be applied.

Aux Effects

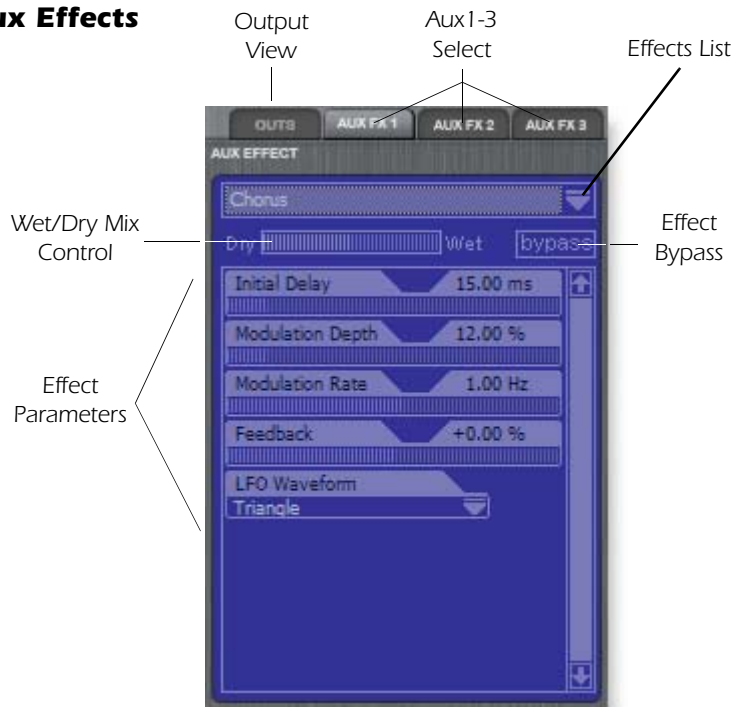

Effects List	Click on the Effects List icon ▼ to show the list of effects.
Aux 1-3 Select	Select between Aux 1, Aux 2, or Aux3 FX in the TV view.
Output View	Selects the Main Output Window. See Main Output Window . (Note: This button is disabled in "Single" mode.)
Wet/Dry Mix Control	Adjusts the ratio of effected signal to un-effected signal.
Effect Bypass	When this button is selected (Red), the effect is completely bypassed, allowing you to hear only the uneffected signal.
Effect Parameters	Each effect has its own set of user adjustable controls.

Preset FX Screen

All effects have a wet/dry mix parameter to control the ratio of effect-to-plain signal, which is stored with the FX preset. Each effect has its own set of control parameters. Turn up the Wet/Dry mix to hear more effect while you adjust the parameters, then turn the amount down to the desired effect amount.

Preset Effects



Effects List	Click on the Effects List icon ▼ to show the list of effects.
FXA / FXB Select	Select between FXA or FXB in the TV view.
Wet/Dry Mix Control	Adjusts the ratio of effected signal to un-effected signal.
Post FX Send Amounts	Adjusts the amount of preset effect signal that will be sent to the Main and Aux Outputs.
Effect Parameters	Each effect has its own set of controls.

► To Get to the Preset FX Screen

1. Select the preset you want in the tree by clicking on the keyboard icon. The Preset Global page appears.
2. Click on the Effect Select Icon ▼ at the top right corner of the Effects TV screen. A list of available effects drops down.

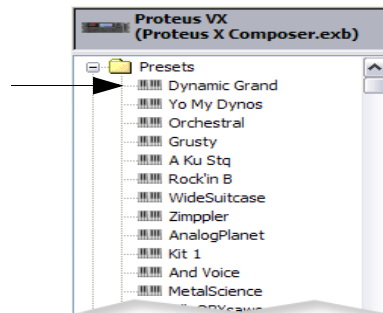

► To Swap FXA and FXB

Effects can sound very different depending on their order in the chain. Here is a simple way to swap FXA and FXB.

1. Choose **Swap Effects** from the Preset pull-down menu.
2. The two effects will exchange positions.

Preset FX Modulation Parameters

Certain parameters in each Preset Effect can be controlled from the Preset Cords. Some effects (such as BPM delay) allow four controllable parameters, while other effects (such as Early Reflections) have only one controllable parameter. If an effect uses less than four parameters, the idle cords are listed as **(unused)**. See below.

The Preset Cord value ADDS to the setting made in the Preset FX screen. For example, if the Wet/Dry Mix were set to 0% and you patched a MIDI Controller to Wet/Dry Mix with an amount of +100, the MIDI Controller would have a full range of control over Wet/Dry Mix. To invert the control, simply set the initial Wet/Dry Mix to 100% and set the Cord amount to -100.

► How to Connect MIDI Controllers to FX Parameters

1. Select the preset you want in the tree by clicking on the keyboard  icon. The Preset Global page appears.
2. Assign FXA or FXB in the Preset FX screen.
3. Select the **Destination** field from the Preset Cords section. A list of all possible Preset Cord destinations appears.
4. The effect modulation parameters are at the bottom of the list. Select the parameter you wish to control.
5. Select the **Modulation Source** you wish to use.

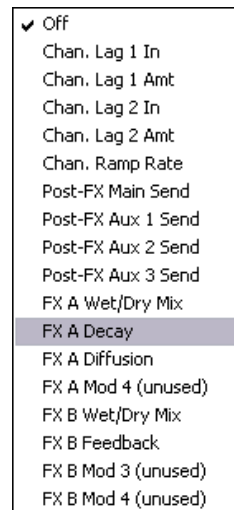

6. Set the **Cord Amount**.
7. In the screen above MIDI Controller K is controlling the Reverb Decay Time.

See [MIDI Channels & Real-time Controls](#) to learn how MIDI controllers work in the Proteus VX.

See [page 22](#) to learn how to assign MIDI controller numbers to the Proteus's A-P reference letters.

Creating, Deleting & Reordering Templates

You can save a library of your favorite effects as *Templates*. Templates are saved with the Proteus VX application so they're always available for use.

► To Create an Effect Template

1. Set the controls as desired for a particular effect.
2. **Right-click** with the mouse anywhere inside the TV screen border. A pop-up menu appears.
3. Select **Save Effects Template** or press "S" while the popup dialog box is visible. The following popup dialog box appears.

OR...

1. Select **Effects Templates** or press "E" from the Multisetup, Preset or Voice menus. A pop-up list of Templates appears.
2. Select **Save Effects Template** or press "S" while the popup dialog box is visible. The following popup dialog box appears.

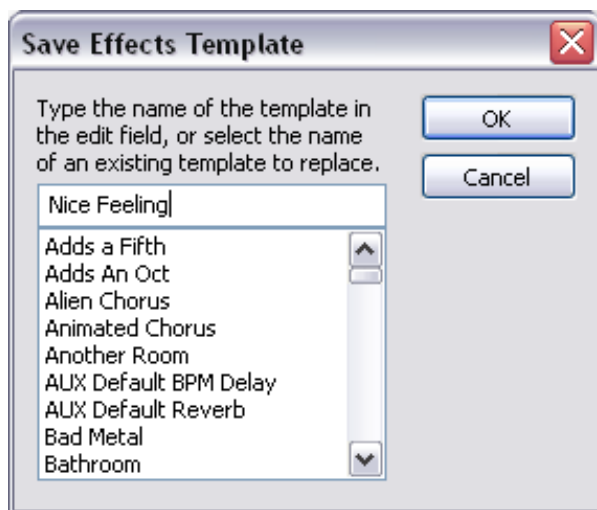

3. Type in a name for your Template and click OK. The Template is saved with the editor program, ready to use when you open any bank.

► To Recall a Template

1. **Right-click** with the mouse anywhere inside the module border. A pop-up menu of Templates appears.
2. Select the desired Template from the list. The Template will be selected.

OR...

1. Select **Effects Templates** or press "E" from the Multisetup, Preset or Voice menus. A pop-up list of Templates appears.
2. **Select the Template** you want and click OK.

► To Rename or Delete a Template

1. **Right-click** with the mouse anywhere inside the module border.
2. Select **Organize Templates**. The following menu appears.

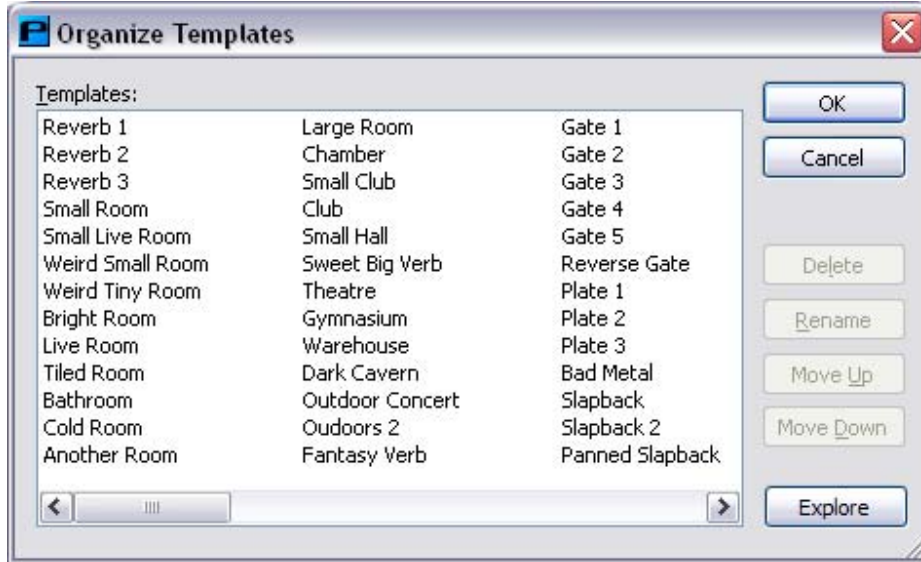

3. Click **Delete** to permanently remove the Template.
4. Click **Rename**, then type in the new name to rename the Template.
5. Click **OK** to close the dialog box.

► **To Change the Order of the Templates**

1. **Right-click** with the mouse anywhere inside the module border.
2. Select **Organize Templates**. The menu shown above appears.
3. Click **Move Up** to move the Template one space up in the list.
4. Click **Move Down** to move the Template one space down in the list.
5. Click **OK** to close the dialog box.

► **To Explore Templates Folders**

1. From the Organize Templates dialog box, click **Explore**.
2. Explore the templates on your computer.
3. Proteus VX stores your templates in the following folder:

Program Files\Creative Professional\Emulator X Family\Templates\

When you click Explore, you are taken to this directory. From here, you can copy or restore existing templates for backup purposes. You can also modify the .xml files with an XML editor.

Effects Listing

Reverb	Delay (mono)	Phaser
Early Reflections Reverb	Early Reflections	Pitch Shifter (mono)
Reverb Lite (mono)	EQ - 1 Band Parametric	Ring Modulator
Chorus	EQ - 4 Band	SP12-ulator
Chorus / Delay (mono)	Flanger	Tremulator BPM
Compressor	Flanger (BPM)	Tube
Delay	Growl	Twin (mono)
Delay (BPM)	Limiter	

Effects Descriptions

Background: Reverb

This information applies to all the reverb algorithms.

Reverberation is a simulation of a natural space such as a room or hall. **Pre-delay** is the time before the reflections from the closest walls are heard. This parameter gives our ears important clues about the size of a room. As you might imagine, large halls have a longer pre-delay than small rooms.

Decay Time defines the time it takes for the reflected sound from the room to decay or die away. The diagram below shows a generalized reverberation envelope.

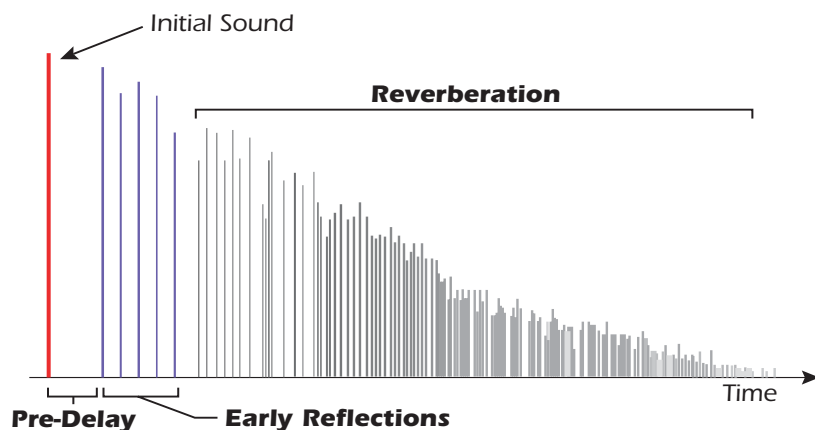

After a short pre-delay period, the echoes from the closest walls or ceiling are heard. The pattern of these first echoes, or **Early Reflections**, vary greatly depending on the type of room. Some time after the early reflection cluster ends, the actual **Reverberation**

(a dense cloud of complex wall reflections) begins and decays according to the time set by the Decay parameter.

Diffusion is the amount of scattering and density of the reverberation cloud. Rooms with many complex surfaces have more diffusion than bare rooms.

High frequency energy tends to fade away first as a sound is dissipated in a room. The **High Frequency Damping** parameter adjusts the time it takes for the high frequency energy to die away and thus changes the characteristics of the room. Rooms with smooth, hard surfaces are more reflective and have less high frequency damping. Rooms filled with sound absorbing materials, such as curtains or people, have more high frequency damping.

Reverb

The Reverb is a medium load reverb, designed to simulate various types of rooms, halls and plates.

Parameter	Description
Decay	Sets the decay time of the entire effect.
Diffusion	Sets the amount of scattering of the reverb cloud. Note that high diffusion settings will increase the overall decay time.
Room Size	Changes the spacing of the reverb stages to simulate rooms of various shapes and sizes.
Early Reflections	Sets the volume of the initial wall reflections.
Pre-Delay	Sets the amount of time before any reflected sound is heard. Range: 1 millisecond to 200 milliseconds
High Freq. Damping	Sets the rate at which high frequencies die away.
Low Freq. Damping	Sets the rate at which low frequencies die away.
Stereo Mode	<p>Independent - In this mode, the left and right sides function as completely separate reverb units.</p> <p>Figure Eight - This mode incorporates criss-cross feedback in which the left channel feeds the right and vice-versa.</p> <p>Matrix - This mode utilizes multiple feedback paths to create a spacious, natural sound.</p>

◆ When using the Figure Eight or Matrix modes, pan position will be less focused and the stereo image will be somewhat blurred.

Modulation Parameters

- Wet/Dry Mix
- Decay
- Diffusion

Early Reflections Reverb

The Early Reflections algorithm is the most resource-intensive reverb model and has the most adjustable parameters. This reverb is designed to simulate various halls, rooms and reverberation plates. See also [“Background: Reverb” on page 72.](#)

Parameter	Description
Pre-Delay	Sets the amount of time before any reflected sound is heard.
Early Reflection Mode	Selects the pattern of the early reflections. Select between: Hall 1, Hall 2, Hall 3, Room, Spiral, Multitap, 6 tap, 12 tap, 12 tap rising, or up & down.
Early Reflection Room Size	Scales the spacing of the early reflections to simulate rooms of different sizes.
Early Reflection L/R Spacing	Scales the spacing of left side reflections versus the right side, to create a more interesting stereo image.
Early Reflection / Tail Balance	Allows you to balance the relative volumes of the early reflections and the reverberation cloud. 0% to 100%
HF Damping	High Frequency Damping cuts the High Frequency content to simulate soft, absorbent surfaces such as draperies, wood or people.

Parameter	Description
LF Damping	Low Frequency Damping cuts the Low Frequency content to simulate hard, reflective surfaces such as tiles or stone.
Tail Decay	Sets the decay time of the reverberation cloud. (RT60)
Tail Diffusion	Sets the amount of scattering of the reverb cloud. At low settings, discrete echoes are heard. At high settings a diffuse wash of sound is heard. High diffusion settings will increase the overall decay time.
Tail Room Size	Changes the spread of the reverberation cloud echoes, simulating rooms of various sizes and shapes.
Tail Stereo Mode	Independent - In this mode, the left and right sides function as completely separate reverb units. Figure Eight - This mode incorporates criss-cross feedback in which the left channel feeds the right and vice-versa. Matrix - This mode utilizes multiple feedback paths to create a spacious, natural sound.

◆ When using the Figure Eight or Matrix modes, pan position will be less focused and the stereo image will be somewhat blurred.

Modulation Parameters

- Wet/Dry Mix
- Decay
- Diffusion

Reverb Lite (mono)

The Reverb Lite is a monophonic, slimmed down version of the Big Reverb. This effect only uses about 3/4 of the DSP resources of the Big Reverb, (and is smaller than even the Chorus effect) making it the perfect choice when you’re running low on CPU horsepower. See also [“Background: Reverb” on page 72.](#)

Parameter	Description
Pre-Delay	Sets the amount of time before any reflected sound is heard.
Decay	Sets the overall decay time of the reverberation effect.
Diffusion	Sets the density of the echoes and scattering of the reverb cloud. At low settings discrete echoes will be heard, At high settings a dense wash of sound is produced. Note: High diffusion settings will increase the overall decay time.
Room Size	Changes the spacing between the reverb stages to simulate rooms of various shapes and sizes.
HF Damping	High Frequency Damping sets the rate at which low frequencies die away. A setting of zero results in no damping.
Pan	This parameter sets the position of the reverberant sound in the stereo field, in order to change the apparent source position.

Modulation Parameters

- Wet/Dry Mix
- Decay
- Pan

Chorus

Background: Chorus

An audio delay in the range of 15-20 milliseconds is too short to be an echo, but is perceived by the ear as a distinctly separate sound. If we now vary the delay time in this range, an effect called chorus is created, which gives the illusion of multiple sound sources. A slight amount of feedback serves to increase the effect. Inverted feedback percentages add negative feedback which can change the tone of the chorus. A very slow LFO rate is usually best for a realistic effect, but a faster LFO rate can also be useful with minimal LFO depth (.2).

This effect is a true-stereo chorus with independent delay lines for the left and right channels. The left and right modulation waveforms are always 180° out of phase, so that left channel delay is increasing while the right channel delay is decreasing and vice-versa. This creates a richer and more animated chorus sound.

Parameter	Description
Initial Delay	Sets the length of the delay. Range: 10ms to 50ms.
Modulation Depth	Sets how much the LFO affects the delay time. Increases the animation and amount of the chorus effect. Range: 0% to 100%
Modulation Rate	Sets the frequency of the low frequency oscillator. Range: .01Hz to 15Hz
Feedback	Sets the polarity and amount of delayed signal that will be recirculated through the delay lines. Range: -99% to +99%
LFO Waveform	Selectable between Sine or Triangle wave.

Modulation Parameters

- Wet/Dry Mix
- Rate (LFO)
- Feedback

Chorus / Delay

This effect is a combination Chorus and Delay because the signal can be delayed up to a full second (1000ms). Slightly modulating the delay time in the 15-20ms range produces the familiar chorus effect. [See “Background: Chorus” on page 75.](#)

When a longer delay is modulated, a kind of gliding pitch shift effect is produced. Vibrato effects can be easily created by adjusting the modulation rate and modulation depth parameters. When feedback is introduced to a long modulated delay, the sound tends to get scrambled up in unpredictable ways which might be just the thing to create that “swarming bees” effect you’ve been looking for.

Setting the feedback percentage in the negative range, inverts the feedback signal. Negative feedback has the effect of deepening the cancellation notches which are created when using short delays with feedback.

- Very short delay times combined with a high feedback amount can be used to create monotone robotic-sounding effects.

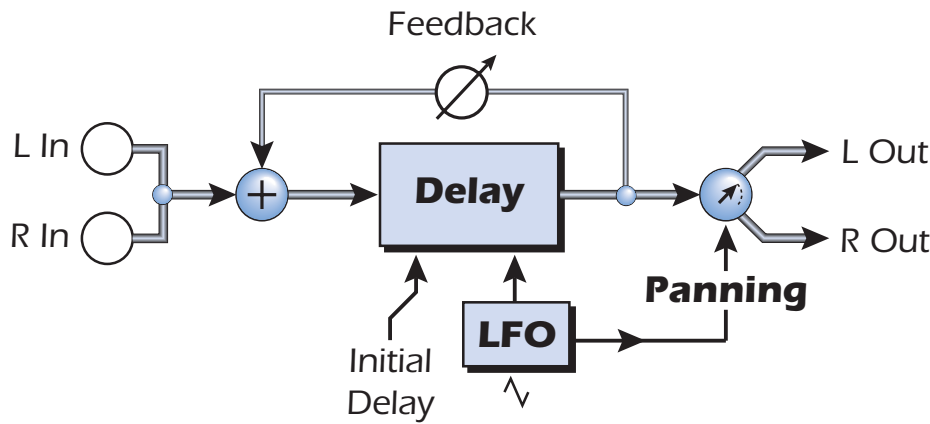

Parameter	Description
Initial Delay	Sets the length of the delay line. Range: 10ms to 1000ms.
Modulation Depth	Sets how much the LFO affects the delay time. Increases the amount of chorus effect and pitch shift animation. Range: 0% to 100%
Modulation Rate	Sets the frequency of the low frequency oscillator. Range: .01Hz to 15Hz
Feedback	Sets the polarity and amount of delayed signal that will be recirculated through the delay line. Range: -99% to +99%
Pan	This parameter moves the delayed sound left or right. This moves the apparent sound source left or right. Range: -99% to +99%
LFO -> Pan	Sets the amount of panning that will occur at the Modulation Rate. Range: -99% to +99%

Modulation Parameters

- Wet/Dry Mix
- Rate (LFO)
- Feedback
- Pan

Compressor

In its simplest form, an audio compressor is just an automatic gain control. When the volume gets too loud, the compressor automatically turns it down. Compressors are useful in musical applications because they smooth out dynamic volume changes and provide a louder average signal level.

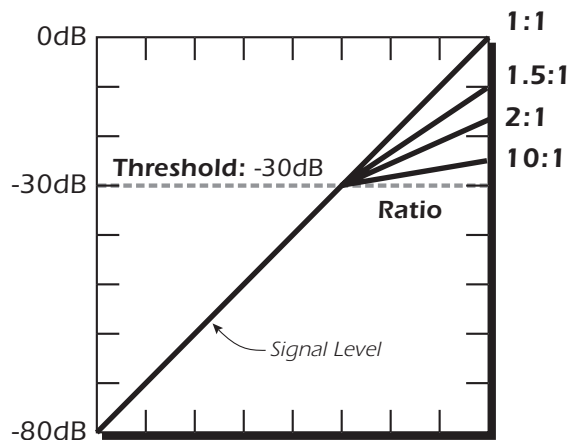

Since the compressor turns down the gain of the signal, you might wonder how can it make the signal level stronger. An Output Gain control allows you to boost the output gain of the compressor in order to make up for the gain reduction. The overall level is higher and only turned down when the signal level gets too loud. The level at which the volume gets turned down is called the *Threshold*, which just happens to be the most important control on the compressor.

Basic Controls

The three main controls of a compressor are the Ratio control, the Threshold control and the Output Gain control.

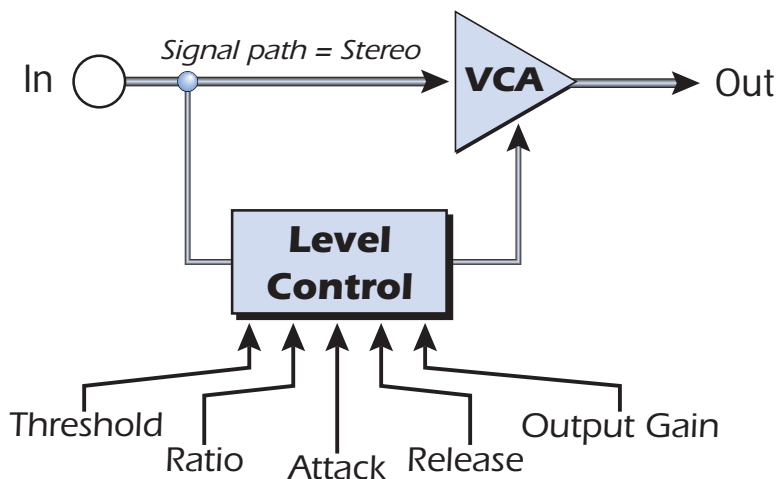

If the signal falls below the *Threshold*, no processing will take place. Signals exceeding the *Threshold* will have gain reduction applied as set by the ratio control. This important control allows you to dial in the range of amplitudes you want to tame. For example, if you're trying to trim off just the loudest peaks, set the threshold high so that compression only occurs during these peaks. **One of the biggest mistakes in**

using a compressor is having the threshold set too low. This adds noise as the compressor will always be reducing the volume.

The *Ratio* control determines how strongly the compressor will affect the signal. The higher the ratio, the more reduction will be applied. If the ratio is high enough, (10:1) the signal will effectively be prevented from getting any louder. In this situation, the compressor will be acting as a *Limiter*, placing an upper limit on the signal level. In general, ratios from 2:1 to 6:1 are considered compression and higher ratios above 10:1 are considered limiting.

The *Output Gain* control amplifies the signal after it has been compressed to bring it back up in volume. If you don't increase the gain, the compressed signal will be much lower in volume.

Two other important controls are *Attack* and *Release*. *Attack* controls how quickly the gain is turned down after the signal exceeds the threshold. *Release* controls how fast the gain is returned to its normal setting after the signal has fallen below the threshold again. An attack setting of about 10 milliseconds will delay the onset of compression long enough to preserve the attack transients in guitar, bass or drums while allowing the sustain portion of the sound to be compressed. Longer release times are generally used to reduce the so called "pumping" effect as the compressor turns on and off. Don't make the release time too long, however, or the compressor won't have time to recover for the next pluck or hit. In general, the attack and release controls are used to smooth out the action of the compressor, but they can also be used to create special effects.

Parameter	Description
Threshold	Threshold sets the "trigger" level for compression. Signal levels above the threshold will be brought down in volume. Range: -50dB to +6dB
Ratio	Sets the ratio of input signal level to output signal level, or "how much" compression will be applied. Range: 0.20:1 to 10:1
Output Gain	Amplifies the signal after it has been compressed to bring up the volume. Range: -24dB to +12dB
Attack Time	Controls how quickly the gain is turned down after the signal exceeds the threshold. Range: 1 ms to 200 ms.
Release Time	Controls how fast the gain is returned to its normal setting after the signal has fallen below the threshold. Range: 0.2 second to 1.0 second

Modulation Parameters

- None

Delay

Background: Delay

A delay line makes a copy of the incoming audio, holds it in memory, then plays it back after a predetermined time.

Long delays produce echoes, short delays can be used for doubling or slapback effects. Very short delays can be used to produce resonant flanging and comb filter effects or create monotone robotic-sounding effects (Hint: use feedback). Stereo signals are summed together before entering a mono delay.

A feedback path recirculates the delayed audio back around through the delay line. When creating echo effects, the **feedback controls how many echoes** will be produced. With short delay settings, the feedback control acts as a *resonance* control, increasing the amount of comb filtering produced by the delay line. [See "Flanger" on page 85.](#)

A Tone control in the feedback path cuts some of the high frequency energy each time the audio goes through the delay line. This simulates the natural absorption of high frequencies in a room and can also be used to simulate tape-based echo units.

The Wet/Dry mix controls how loud the echoes are in relation to the original signal.

This Delay is a true stereo delay line with completely independent left and right channels right channels. This delay line features four different modes, which affect how the signals are routed and cross coupled.

Discrete stereo

Use this mode when you want to preserve the stereo image of the delayed signals. You can also create panning effects by setting one delay long and the other short.

Delay Mode:

Discrete stereo

The left and right channels are kept totally separate.

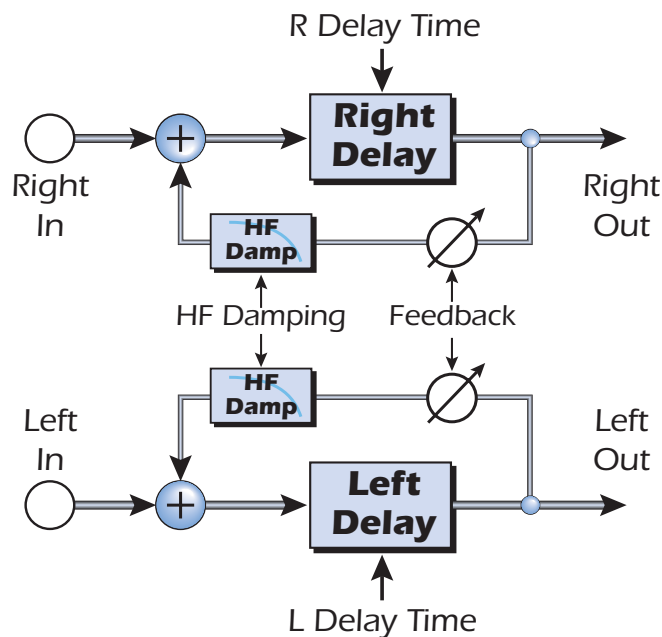

Ping Pong, stereo

This mode cross-couples the output of the left and right delay into the input of the opposite channel. This mode works best with true stereo program material or with completely different sounds on either channel.

Delay Mode:

Ping Pong, stereo

The output of the left and right channels are fed into the opposite channel.

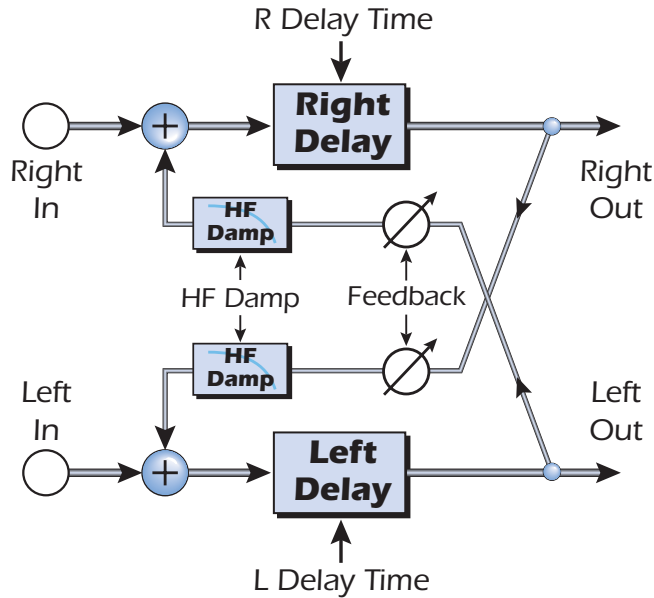

Ping Pong, mono L->R

This mode creates echoes which bounce back and forth from left to right using either a mono or stereo source. This is the classic ping-pong echo effect.

Delay Mode:

Ping Pong, mono L->R

The input is summed to mono, then fed into the left channel. The output of the left channel is cross-coupled into the right channel. The right channel output is cross-coupled into the left channel input.

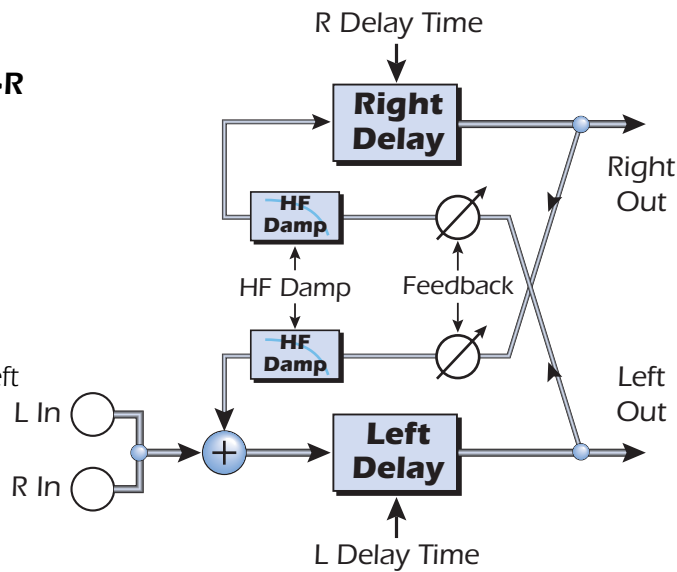

Parameter	Description
Left Delay Time	Sets the length of the delay for the left channel in milliseconds. Range: .01 millisecond to 2000 milliseconds (.01ms. minimum increment between settings)
Right Delay Time	Sets the length of the delay for the right channel in milliseconds. Range: .01 millisecond to 2000 milliseconds (.01ms. minimum increment between settings)
Mode	Changes the signal routing of the delay. The four modes are: Discrete stereo - signal paths remain completely separate. Ping Pong, stereo - The feedback paths feed the opposite channel. Ping Pong, mono L->R - The effected signal is summed to mono, then fed down the left channel whose feedback path feeds the right channel. The right channel feedback path feeds the left channel. Ping Pong, mono R->L - This is the same as the previous algorithm except that the L-R channels are reversed.
Feedback	Sets the amount of delayed signal that will be recirculated through both delay lines. Range: 0% to 100%
HF Damping	High Frequency Damping cuts the high frequency content in the feedback paths. This causes the echoes to decay naturally away.

Modulation Parameters

- Wet/Dry Mix
- Feedback

Delay (BPM)

The BPM Delay is similar to the Stereo Delay except that the delay time is synchronized to the master (MIDI) clock in note divisions. This allows you to easily set up synchronized echoes to your beats. Because the left and right channels are completely independent, you can set up different synchro-sonic patterns on each side. The four modes are the same as the stereo delay.

Delay Mode:

Discrete stereo

The left and right channels are kept totally separate.

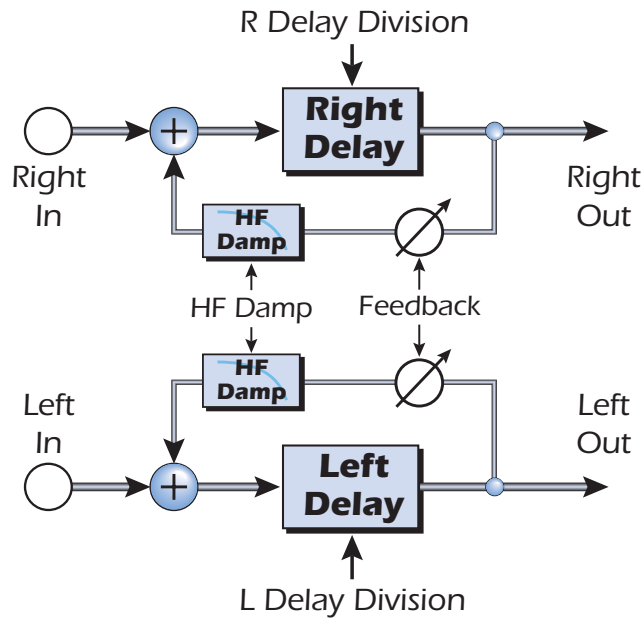

◆ See [page 79](#) for full descriptions and diagrams.

Parameter	Description
Left Delay Division	Sets the length of the delay for the left channel in milliseconds. Range: 4/1 note to 1/64 dotted-note
Right Delay Division	Sets the length of the delay for the right channel in milliseconds. Range: 4/1 note to 1/64 dotted-note
Mode	Changes the signal routing of the delay. The four modes are: Discrete stereo - signal paths remain completely separate. Ping Pong, stereo - The feedback paths feed the opposite channel. Ping Pong, mono L->R - The effected signal is summed to mono, then fed down the left channel whose feedback path feeds the right channel. The right channel feedback path feeds the left channel. Ping Pong, mono R->L - This is the same as the previous algorithm except that the L-R channels are reversed.
Feedback	Sets the amount of delayed signal that will be recirculated through both delay lines. Range: 0% to 100%
HF Damping	High Frequency Damping cuts the high frequency content in the feedback paths. This causes the echoes to decay naturally away

Modulation Parameters

- Wet/Dry Mix
- Left Delay Division (Changes the division by a power of 2, up or down.)
- Right Delay Division (Changes the division by a power of 2, up or down.)
- Feedback

Early Reflections

Early reflections are the initial echoes that you hear when listening to sound in an indoor space. The echoes are staggered because they are reflected off surfaces which are at various distances from your ear. Normally this effect would be part of a reverb algorithm, but we decided to include it as a separate effect because it creates useful and interesting sounds.

Parameter	Description
E.R. Mode	Selects the pattern of the early reflections. Select between: Hall 1, Hall 2, Hall 3, Room, Spiral, Multitap, 6 tap, 12 tap, 12 tap rising, up & down.
Room Size	Changes the spacing of the early reflections characteristics of various room sizes and shapes.
L/R Offset	Scales the spacing of left side reflections versus the right side, to create a more interesting stereo image. Range: -50% to +50%

Modulation Parameters

- Wet/Dry Mix

1-Band Para EQ

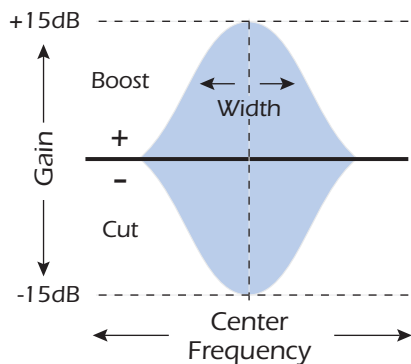

This single band parametric equalizer is useful when you just want to boost or cut a single range of frequencies. For example, if you just want to brighten up the lead vocal a bit, you might choose this EQ. This EQ offers up to +15dB boost and -24dB of cut.

Parameter	Description
Gain	Sets the amount of cut (-) or boost (+) of the selected frequency band. Range: -24dB to +15dB
Center Frequency	Sets the range of frequencies to be cut or boosted with the Gain control. Range: 40Hz to 16kHz
Bandwidth	Sets the width of the frequency range for the Center Frequency band that will be cut or boosted by the Gain control. Range: .01 octave to 2 octaves

Modulation Parameters

- Gain
- Frequency
- Bandwidth

■ **Tip** - EQ becomes a powerful performance tool when the modulation parameters are patched to MIDI Controllers.

4-Band EQ

This 4-band equalizer provides two shelving filters at the high and low ends of the frequency range and two fully parametric bands in the center. Up to +15 dB of boost and -24dB of cut is provided for each band.

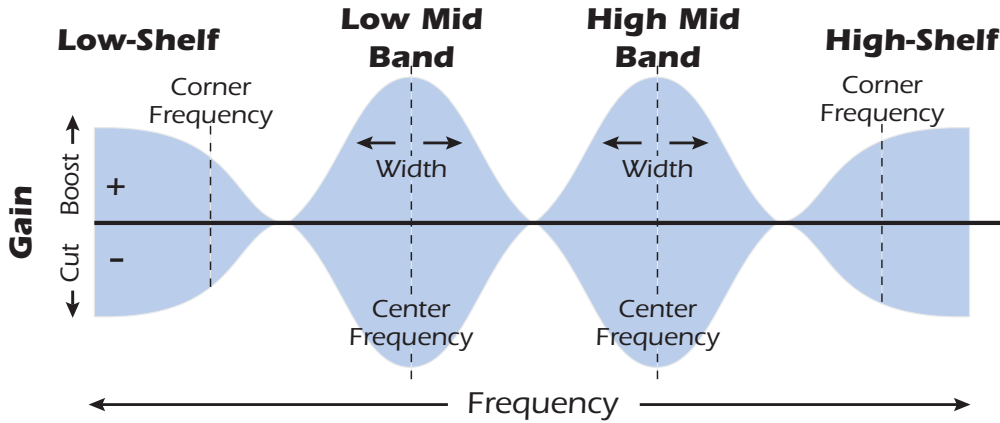

◆ **Note:** The Wet/Dry Mix control on an equalizer should normally be set to 100% wet or unpredictable results may occur.

Parameter	Description
High Gain	Sets the amount of cut (-) or boost (+) of the high frequency shelf. Range: -24dB to +15dB
High Frequency	Sets the corner frequency where the signal begins getting cut or boosted with the High Gain control. Range: 4kHz to 16kHz
High Mid Gain	Sets the amount of cut (-) or boost (+) of the High Mid Frequency band. Range: -24dB to +15dB
High Mid Frequency	Sets the range of frequencies to be cut or boosted with the High Mid Gain control. Range: 1kHz to 8kHz
High Mid Bandwidth	Sets the width of the frequency range for the High Mid Center Frequency band that will be cut or boosted by the High Mid Gain control. Range: .01 octave to 2 octaves
Low Mid Gain	Sets the amount of cut (-) or boost (+) of the Mid 1 Frequency band. Range: -24dB to +15dB
Low Mid Center Freq.	Sets the range of frequencies to be cut or boosted with the Mid 1 Gain control. Range: 200Hz to 3kHz
Low Mid Bandwidth	Sets the width of the frequency range for the Low Mid Center Frequency band that will be cut or boosted by the Low Mid Gain control. Range: .01 octave to 2 octaves
Low Gain	Sets the amount of cut (-) or boost (+) of the low frequency shelf. Range: -24dB to +15dB
Low Frequency	Sets the corner frequency where the signal begins getting cut or boosted with the Low Gain control. Range: 40Hz to 800Hz

■ **Tip:** When using a MIDI controller to change the EQ gain, a value of 77 = 0dB.

Modulation Parameters

- High Gain
- High Mid Gain
- Low Mid Gain
- Low Gain

Flanger

A flanger is a very short delay line whose output is mixed back together with the original sound. Mixing the original and delayed signals results in multiple frequency cancellations known as a comb filter. Since the flanger is a type of filter, it works best with harmonically rich sounds.

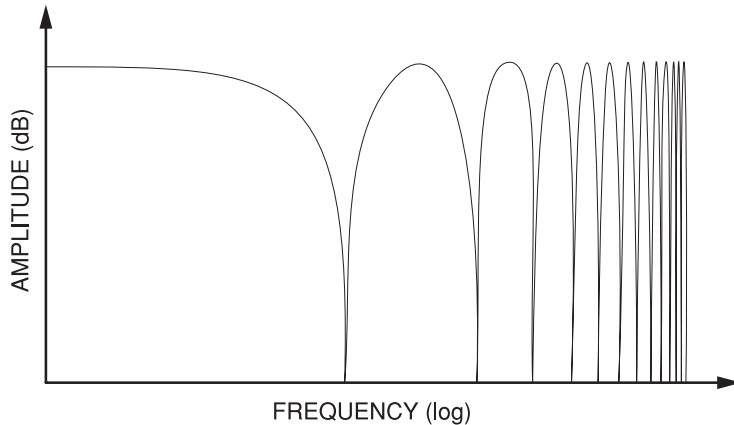

A low frequency oscillator is included to slowly change the delay time. This creates a rich, sweeping effect as the notches move up and down across the frequency range. The amount of feedback deepens the notches, intensifying the effect. You can invert the feedback signal by choosing a negative feedback value. Inverting the feedback signal creates peaks in the notch filter and deepens the effect.

■ In order to hear a rich flanging effect, the original signal must be mixed in with the flanged signal. This can be accomplished using the Wet/Dry Mix control or with the Main Send (when using Aux effects).

Parameter	Description
Initial Delay	Sets the initial delay of the flanger in .01 millisecond increments. This parameter allows you to “tune” the flanger to a specific frequency range. Range: .01 ms to 4ms
Depth	Sets how much the LFO affects the delay time. Increases the animation and amount of the flanging effect. Range 05 to 100%
Rate	Sets the speed of the low frequency oscillator which modulates the delay time of the flanger. Range: .01 Hz to 20Hz
Feedback	Controls how much signal is recirculated through the delay line and increases resonance. Negative values can produce intense flanging with some signals. Range 0% to 100%
Through Zero	On - Adds a short delay to the original signal to simulate the classic “through-zero” flanger sound, which was originally created using two tape recorders. On (out of phase) - Inverts the phase (180°) and adds a delay to the original signal producing additional phase cancellation. If the feedback control is set to zero, complete cancellation occurs when the flanger goes through zero

Modulation Parameters

- Wet/Dry Mix
- Depth (Mod)
- Rate (Mod)
- Feedback

Growl

This is a new kind of self-modulation effect created especially for the Proteus VX. Growl excels at turning simple sounds into musically complex and interesting ones. Depending on the input wave and control settings, Growl can impart a horn-like quality, a warm tube distortion, or a harsh rasp.

Growl is easy to use. Just turn up the depth control and wet/dry mix, then adjust the Initial control until you find the right amount of "growl". Then, back off the other controls and a fine tune all the other controls to taste. It's Grrreat!

Parameter	Description
Initial	This control "Tunes" the effect to a specific frequency range. Range: .01ms to 15ms
Depth	Sets how much self modulation is applied. Range 0% to 100%
Color	Controls the tonal color of the effect. Range: -99% to +99%
Pre-Filter	Anti-aliasing filter. Turn this filter up if you hear aliasing at high-frequencies.

Modulation Parameters

- Wet/Dry Mix
- Depth
- Color

Limiters

The Limiter sets a “maximum level” on the audio. Beyond this *Threshold*, any increase in gain is effectively prevented or limited, hence the name. A limiter works like a compressor with a very high ratio setting.

The limiter is particularly useful for taming the highly resonant peaks that can be produced by the Z-plane filters. Set a fast attack time to suppress transients and use the Release control to reduce “pumping” effects.

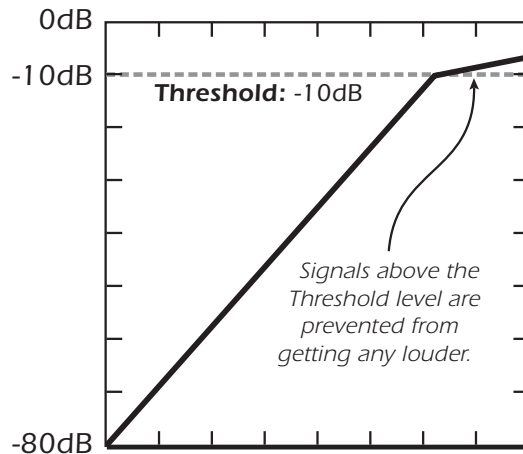

The *Output Gain* control amplifies the signal after it has been limited to bring it back up in volume. If you don’t increase the gain, the signal may be lower in volume.

Two other controls are *Attack* and *Release*. Attack controls how quickly the gain is turned down after the signal exceeds the threshold. Release controls how fast the gain is returned to its normal setting after the signal has fallen below the threshold again. Longer release times are generally used to reduce the so called “pumping” effect as the compressor turns on and off. Don’t make the release time too long, however, or the compressor won’t have time to recover for the next pluck or hit. In general, the attack and release controls are used to smooth out the action of the limiter, but they can also be used to create special effects.

Parameter	Description
Threshold	Threshold sets the “trigger” level for limiting. Signal levels above the threshold will be brought down in volume. Range: -50dB to +20dB
Output Gain	Amplifies the signal after it has been compressed to bring up the volume. Range: -24dB to +12dB
Attack Time	Controls how quickly the gain is turned down after the signal exceeds the threshold. Range: 1 ms to 200 ms.
Release Time	Controls how fast the gain is returned to its normal setting after the signal has fallen below the threshold. Range: 0.2 second to 1 second

Modulation Parameters

- None

Phaser

A Phaser (or phase shifter) produces a fixed number of peaks and notches in the audio spectrum which can be swept up and down in frequency with a low frequency oscillator (LFO). This creates a swirly, ethereal sound with harmonically rich sound sources of a type of pitch shift with simpler sounds. The phase shifter was invented in the 1970's and the characteristic sound of this device evokes emotions of that musical era.

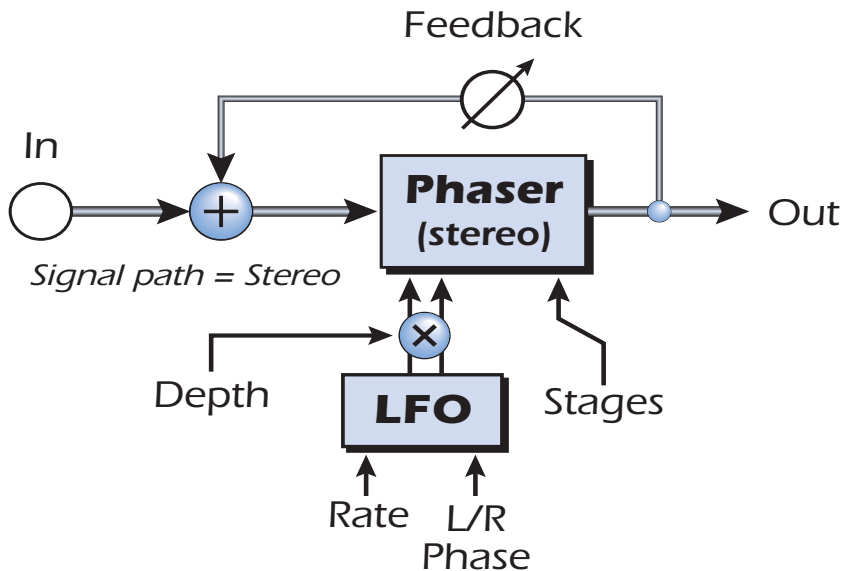

Parameter	Description
Depth	Controls how much the Center Frequency is swept by the LFO. Range: 0% to 100%
Rate	Controls the sweep rate of the Low Frequency Oscillator. Range: .01Hz to 20Hz
Feedback	Increases the depth of the notches and height of the peaks. Inverted values invert the feedback polarity. Range: -100% to +100%.
Stages	Selects between: 3, 6, 9, or 12 phase shift stages and thus the number of peaks and notches in the frequency response.
LFO L/R Phase	Offsets the LFO between the left and right phaser channels. (0°, 90°, or 180°). This adds animation to the sound.

Modulation Parameters

- Wet/Dry Mix
- Depth (Modulation)
- Rate (Modulation)
- Feedback

Pitch Shifter (mono)

The pitch shifter (also known as a “harmonizer”) shifts the pitch of the input up or down while preserving the time between events. (Unlike speeding up or slowing down a tape recorder or pitch shifting across the Proteus VX keyboard.) The range of the pitch shifter is -36 semitones down to +24 semitones up in .01 semitone increments.

Small amounts of pitch shifting makes an effective type of chorus. Semitone shifts work especially well on the human voice for harmonization and for special effects. With the Feedback control turned up, the pitch shifted (and slightly delayed) signal will be recirculated through the pitch shifter and re-shifted further up or down.

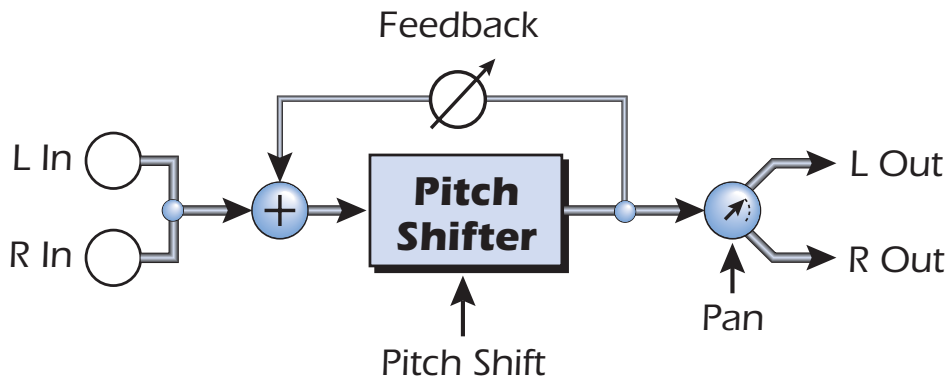

Parameter	Description
Pitch Shift	This control selects the pitch shift interval. Range: -36 semitones to +24 semitones
Feedback	Controls how much signal is recirculated through the pitch shifter. Range 0% to 100%
Pan	This parameter moves the pitch shifted sound left or right. This moves the apparent sound source left or right.

Modulation Parameters

- Wet/Dry Mix
- Pitch
- Feedback
- Pan

Ring Modulator

A ring modulator takes two signals and multiplies them together to produce an output signal containing only the sum and difference frequencies of the two input waves. The original frequencies are not output. If complex waveforms are used, every harmonic of each signal multiplies every other according to its amplitude. Because ring modulation is a linear process, these new sum and difference frequencies are displaced from their normal exponential harmonic relationship. As a result, ring modulators tend to create clangorous, bell-like timbres.

In this ring modulator, each side of the stereo input source is multiplied by an internal sine wave oscillator. The internal oscillator can remain at a fixed pitch or it can be modulated by an envelope follower.

The envelope follower sweeps the pitch of the modulating oscillator up or down based on the amplitude of the input signal. Try adjusting the Proteus VX attack and decay controls (amp) to hear the effect of the envelope follower. The envelope follower can sweep the modulating oscillator in either the positive or negative direction by setting the value positive or negative.

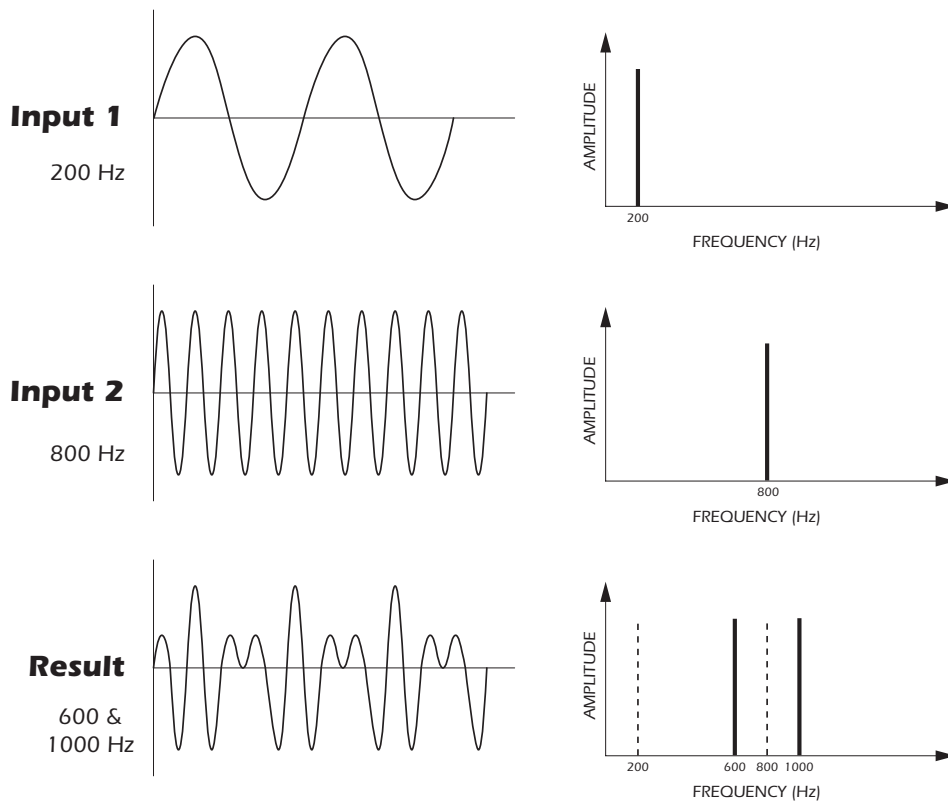

This diagram shows the result of Ring Modulating two sine waves with frequencies of 200 Hz & 800 Hz. Only the Sum and Difference frequencies of 600 Hz and 1000 Hz will be output.

Parameter	Description
Frequency	This control sets the frequency of the modulation waveform Range: 0 Hz to 5000 Hz
Envelope Follower	Controls how much the amplitude envelope sweeps the modulating oscillator. Range: -10x to +10x

Ring Modulator

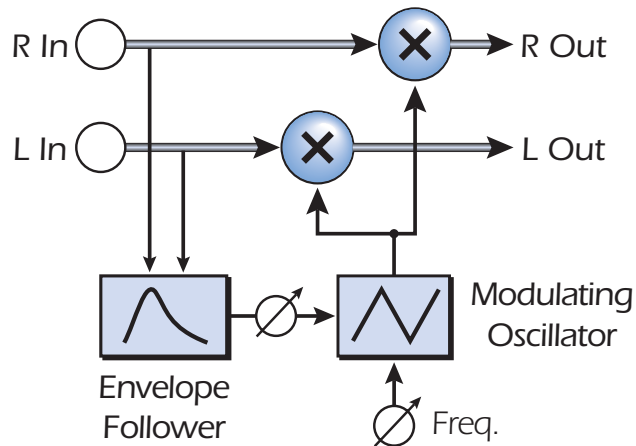

Modulation Parameters

- Wet/Dry Mix
- Frequency
- Envelope Amount

SP12-ulator

The E-MU SP-12 Sampling Drum Machine was the most advanced beat box of its day and remains a classic. The SP-12 used a gritty, “drop-sample” pitch shifting technique which contributed to its distinctive sound. The SP12-ulator effect pays homage to the venerable SP-12, and allows you to mangle sounds as your forefathers did many years ago.

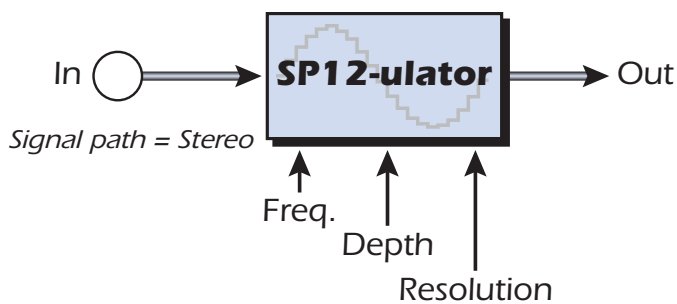

Parameter	Description
Frequency	This parameter controls the number of samples that will be “dropped.” Range: 0 - 100
Depth	This parameter controls the intensity of the resultant distortion. Range: 0% to 100%
Resolution	The SP-12 is a 12-bit drum machine. The SP12-ulator allows you to reduce the bit depth to 12-bits, or all the way down to 1-bit resolution if you must. Range: Hi-Res (32 bit), 12-bit to 1-bit

Modulation Parameters

- Wet/Dry Mix
- Frequency
- Depth

Tremulator BPM

Tremolo is amplitude modulation and is also a standard guitar amp effect. The Tremulator BPM is more like a tremolo on steroids! In addition to the standard rate and amount controls, the Tremulator lets you beat-sync the tremolo speed to the song tempo, has eight different modulation waveforms with adjustable lag, lets you autopan the stereo signal in several ways, and even includes a sweepable lowpass filter with five modes.

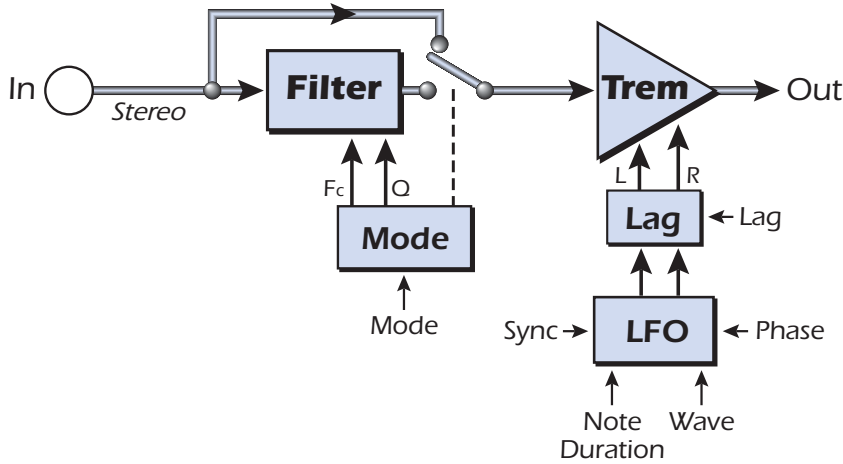

Parameter	Description
Wet/Dry	Controls the intensity (depth) of the tremolo effect. Range: 0% to 100%
LFO Note Duration	The speed of the LFO is locked to a note division of the master tempo. Range: 4/1 note to 1/64 dotted-note
LFO Waveshape	Selects between the following modulation waveforms: Sine, Triangle, Half Sine, Sawtooth Up, Sawtooth Down, Square, Pulse 25, Pulse 75
Lag	Sets the slew rate of the LFO output. This is normally used to round the corners of the square waves, but can create interesting effects with the other waveforms as well. Range: 0% to 100%
L/R Phase	Offsets the LFO phase between the left and right channels. (0°, 90°, 180°, 270°). 0° - Both the left and right channels are the same. 180° - Creates a back and forth, "ping-pong" effect. 90°/270° - Creates a rotating effect.
Mode	Six different modes are available: <ul style="list-style-type: none"> • Tremolo - Tremolo amplitude modulation only • Tremolo + Filter 1 - Tremolo & 2-pole filter sweep, no Q • Tremolo + Filter 2 - Tremolo & 2-pole filter sweep, Mid Q • Filter 3 - 2-pole filter sweep, Low Q • Filter 4 - 2-pole filter sweep, Mid Q • Filter 5 - 2-pole filter sweep, High Q Note: The initial filter frequency is set lower as the Q is increased.
Sync (LFO Phase)	Re-syncs the LFO (to the peak of the wave) whenever this button is pressed or whenever the sync modulation input goes from zero to a positive value. You could connect a footswitch.

Tremulator Waveforms

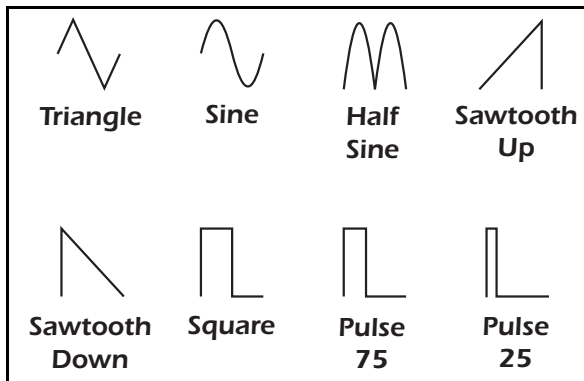

Modulation Parameters

- Wet/Dry Mix
- Rate (LFO Note Duration)
- Waveshape
- Sync

Tube

The Tube is a tube amplifier simulator based on “soft clipping”. An overdriven tube amplifier sounds good because it generates even harmonic distortion products. This digital tube gently rounds the waveform in a smooth, controlled manner much like a real vacuum tube. Set the amount of distortion using the Gain control, then adjust the tone using the Treble and Bias controls. The Compression control smooths out volume changes and the Output Level control sets the final volume of the effect.

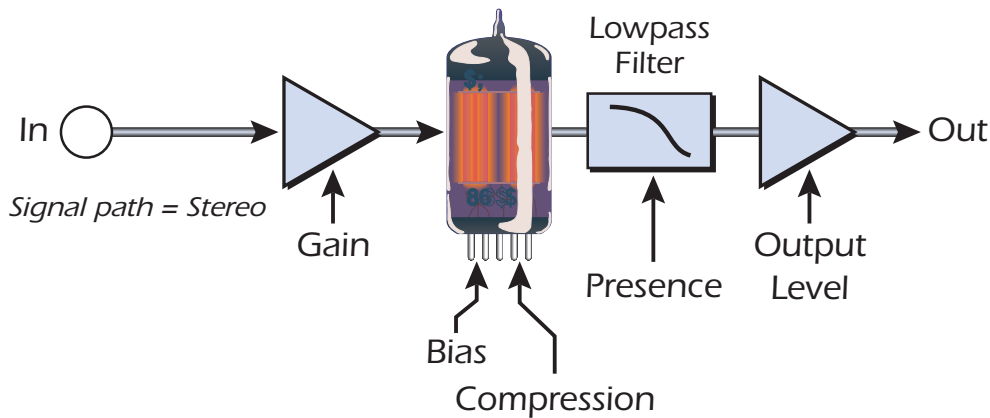

Parameter	Description
Gain	This parameter controls the overdrive amount on the “tube” and thus, the amount of distortion generated. Range: 0.25 - 50.00
Output Level	This parameter sets the output volume level and has no effect on the tone.
Presence	This control sets the lowpass filter frequency at the output of the “tube”.
Compression	Tubes have a certain amount of natural “soft” compression. This controls how much compression is applied.
Bias	Bias controls at what point in the waveform clipping begins.

Modulation Parameters

- Wet/Dry Mix
- Gain
- Output Level

Twin

The Twin utilizes two “tube” stages to simulate the overdrive response of a guitar amplifier. Separate gain controls allow you to precisely control the amount of soft clipping from each “tube” stage. A three-band tone control between the two stages and a presence control after the 2nd stage allow you to precisely contour the overdrive frequencies. Set the amount of distortion using the Volume and 2nd Stage Gain controls, then adjust the tone using the Treble, Mid and Bass controls. The Compression control smooths out the timbral changes and the Output Level control sets the final volume of the effect.

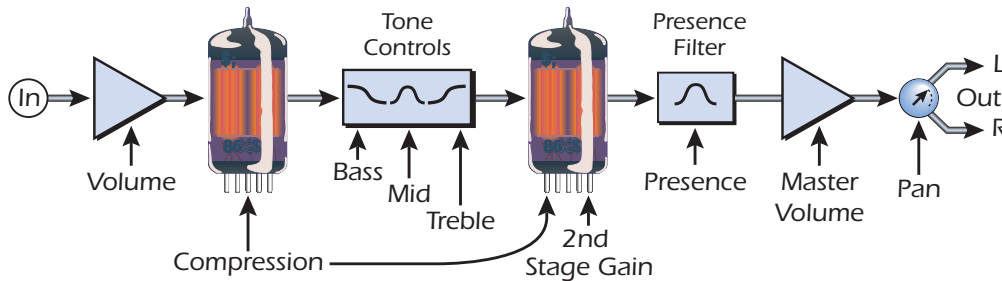

Parameter	Description
Volume	This parameter controls the overdrive amount on the 1st “tube” and thus the amount of distortion generated.
Master Volume	This parameter sets the output volume level and has no effect on the tone.
Treble	Allows you to adjust the high frequency content between the two “tubes”.
Mid	Allows you to adjust the mid frequency content between the two “tubes”.
Bass	Allows you to adjust the low frequency content between the two “tubes”.
2nd Stage Gain	This parameter controls the overdrive amount on the 2nd “tube” and thus, the amount of distortion generated.
Presence	Allows you to adjust the mid frequency content at the output of the 2nd “tube”.
Pan	Sets the left/right pan position of the processed sound. Range: -100% to +100%
Compression	Tubes have a certain amount of natural “soft” compression. This controls how much compression is applied by both tubes.

Modulation Parameters

- Wet/Dry Mix
- Gains 1 & 2
- Master Volume
- Pan

5 - Effects
Effects Descriptions

6 - Controls

This chapter describes how to operate the controls of the Proteus VX. There are certain tips and tricks to learn in becoming a power user, and a good number of them are in this chapter.

The Toolbars

The toolbars are located just beneath the menu bar at the top of the window and one more at the very bottom of the window (the status toolbar). The toolbars provide handy single-click buttons for the most common operations. By holding the mouse pointer over the tool, a label will appear revealing the purpose of each tool.

The Status Toolbar is always located at the very bottom of the window and provides context sensitive information, such as the current MIDI channel, preset name & number, as well as the number of samples currently playing.

Menu Toolbars

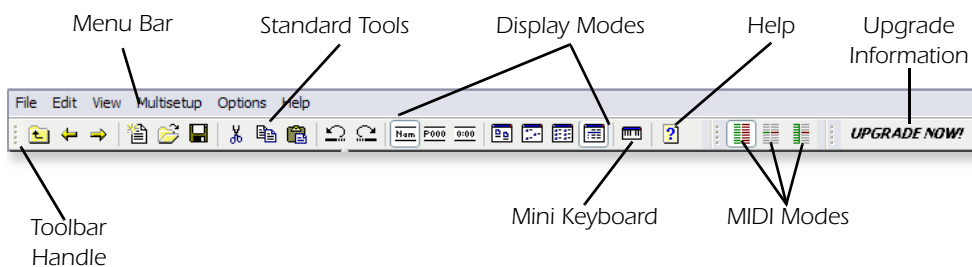

Status Toolbar

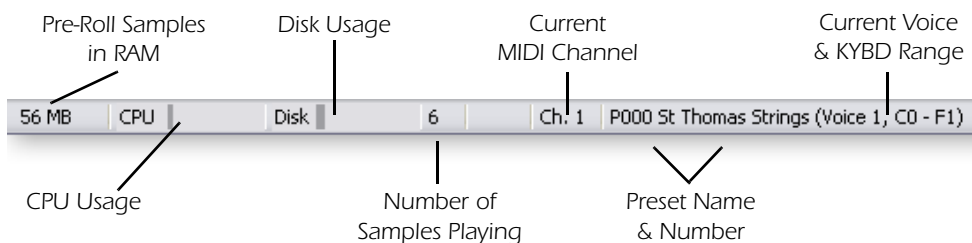

Viewing and Hiding the Toolbars

Select **Toolbars** from the **View** menu to call up the Show/Hide Toolbar menu. Check the boxes of the toolbars you wish to view. “Flat Toolbars” changes the look of the toolbars.

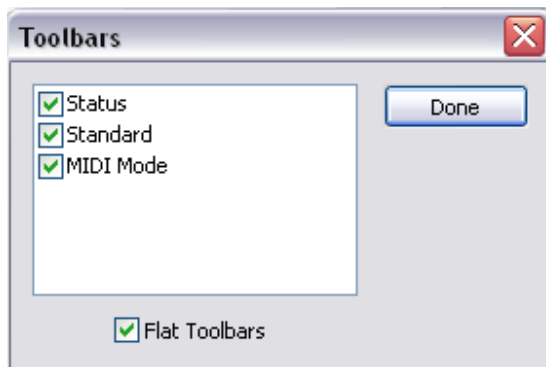

Drag & Drop

You can use simple “Drag & Drop” operations for many Proteus VX functions. For example, to copy a voice to another preset, simply left-click on the voice icon, then drag it on top of another preset and release the mouse. Page [122](#) provides a complete listing of the drag & drop functions.

Changing Settings

Entering Numeric Values

Numeric values are displayed in alphanumeric readouts with either an associated control knob or an up/down button adjoining the display.

► **Numeric values can be changed by:**

- **Turning the knob** (if there is one).
- Pressing the **Up/Down** keys when the cursor is over a field.
- **Typing** the desired value into the field.

► **Move the Cursor from the Keyboard**

- Press the **Tab** key to move the cursor to the next field.
- Press **Shift+Tab** to move the cursor to the previous field.

► **Select the Knob or Slider and then:**

- Use the **Left/Right** keys to increment or decrement the value by 1.
- Use the **Page Up & Page Down** keys increment or decrement by 10.
- Use the **Wheel** on a wheel-type mouse to increment or decrement the value.
- Press the **Home** key to turn the control all the way down.
- Press the **End** key to turn the control all the way up.
- Press the **5** key in the **numeric keypad** to center the control. (Num Lock must be off)

View Menu

The View Menu gives you a grand overview of your presets and multisetups. When the "Details" view is selected, the ID Number, Bank-Program Number, and Category is shown for each preset or multisetup. In Details View, lists can be sorted by clicking on the column header.

The View menu is extremely handy when creating new banks since it allows you to select multiple presets at a time to delete or to merge into a new bank. (*Hint: Drop them onto the Proteus VX icon.*) The View menu also makes it easy to edit the category of multiple presets.

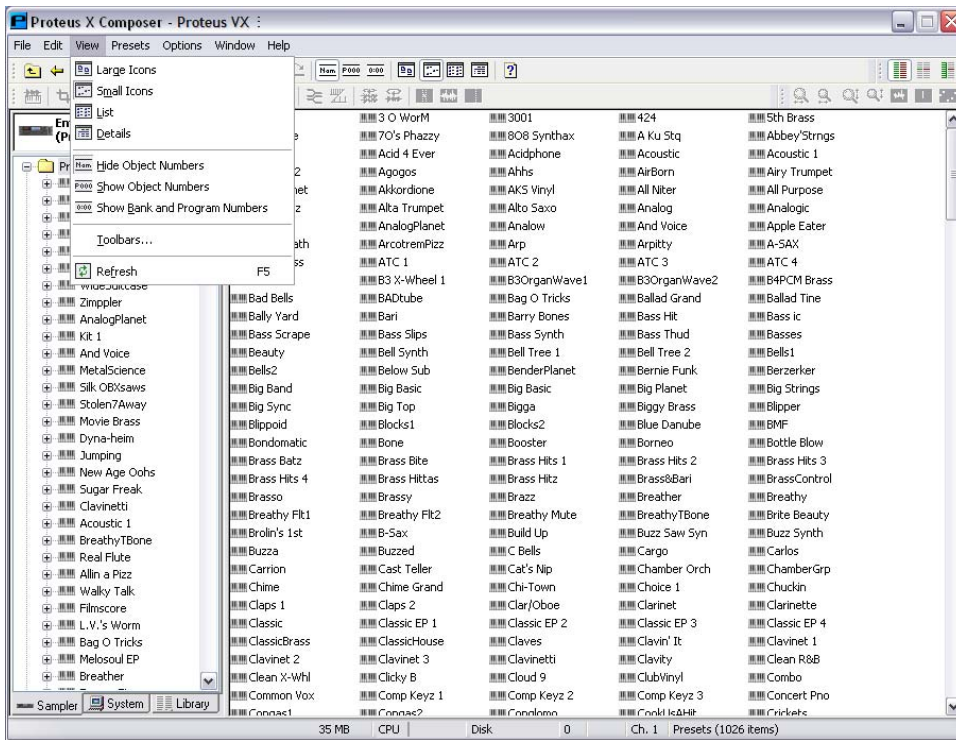
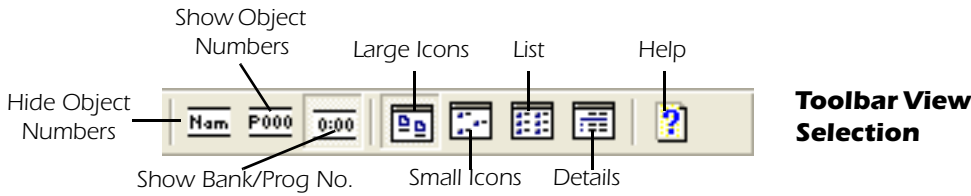

Main Display View

When in the Preset or Multisetup Tree, clicking on the preset folder shows all the presets in the bank in the large window. The **View Menu** provides several display options for presets and multisetups. The view options are listed below:

- Large Icons** Displays large icons useful for smaller banks
- Small Icons** Displays small icons (shown above) useful for large banks
- List** Displays Presets in a list view format (in numerical order)
- Details** Displays the ID Number, Bank-Program Number, and Category. Clicking on the Category button at the top of each column sorts the list by that category.

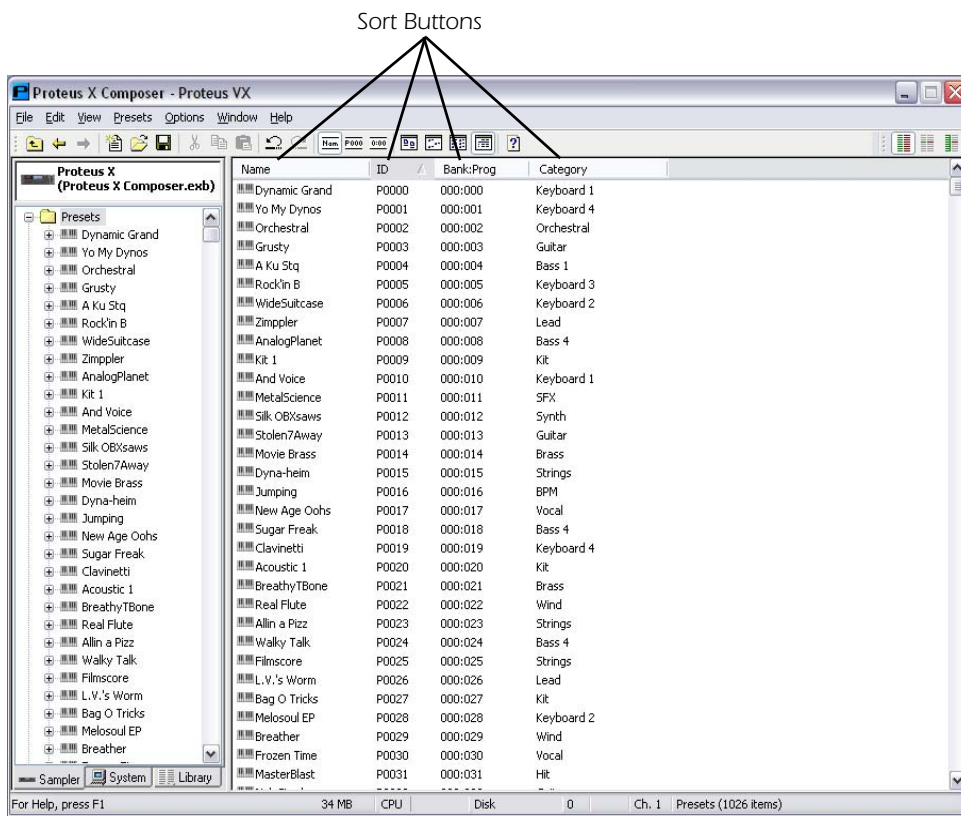

Tree View

The Preset or Multisetup Tree items can also be viewed in several ways. The **View Menu** provides several display options for the tree. The view options are listed below:

- Show/Hide Object Numbers** Displays or hides the object number for the Preset or Multisetup.
- Show Bank & Program Numbers** Presets can be displayed in the tree with Object numbers (P003) or with Bank and Program numbers (002:003).

Tree Navigation using the Keyboard

Cursor Keys

You can move quickly through the Tree using the Left-Right-Up-Down Cursor Keys.

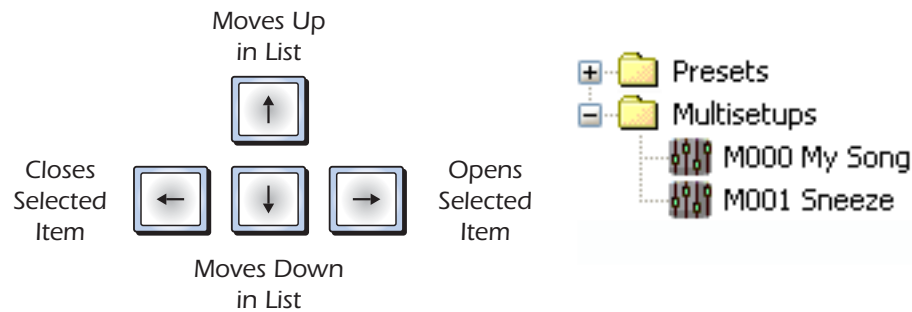

With the Presets folder selected as in the example above, pressing the right cursor will open the presets folder.

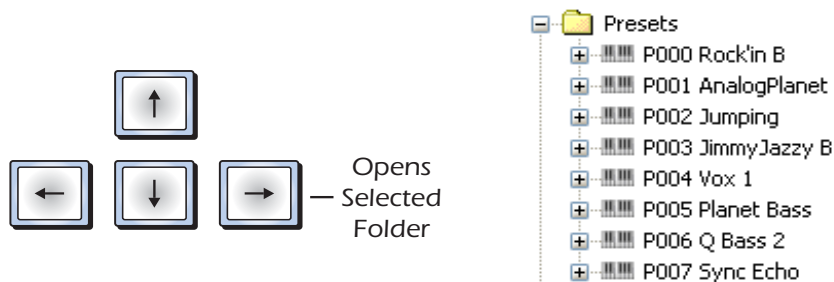

The **Left Cursor** reverses the actions. The **Up-Down Cursors** move up and down within the list. The **Enter** key opens the item.

Find Items

When the cursor is positioned in a list such as the tree, you can locate specific presets by simply typing the name. Typing the first letter of a name finds the first preset beginning with that letter. Repeatedly typing the same letter finds the next item beginning with that letter, and so on.

When "Show Object Numbers" is selected, you can type the preset number (preceded by the letter P) to locate items by number.

Refresh (F5)

Sometimes the display does not reflect the state of the synthesizer or vice-versa. Pressing F5 or selecting Refresh from the View menu manually synchronizes the display and synth.

Context Sensitive Menus

The right mouse button brings up context-sensitive menus in many areas of the Proteus VX. Simply right-click over the field or area to bring up the menu for that function. Please refer to [page 121](#) for a complete listing of context-sensitive menus.

Undo/Redo

Almost every action you do with the Proteus VX can be undone. You can undo up to 100 actions. Select Undo or Redo from the Edit menu or press Ctrl+Z (Undo) or Ctrl+Y (Redo) from the keyboard.

7 - Synthesizer Basics

Proteus VX is a “Lite” version of our Proteus X2 and Emulator X2 products, and as such it does not have all the capabilities of the full products. This chapter contains background information on various programming aspects of synthesizers in general and is also a “teaser” for the full Proteus X2 and Emulator X2 products. Proteus X2 provides full preset programming; Emulator X2 contains all features of Proteus X2 and adds intelligent sampling and a host of powerful sample editing features.

Proteus VX uses the same sampling/synthesis engine and the same sound library as its brethren and it sounds spectacular. The 16 controller knobs have been assigned to control 16 basic parameters of each preset and using these controls, you can completely reshape and transform the 1024 presets.

If you are new to synthesizers and electronic music, you may require more background information than this manual provides. There are many books dedicated to synthesizer basics and MIDI available through your local music dealer. Magazines such as Keyboard and Electronic Musician, available at most newsstands, contain current information on the subject, as well as valuable programming tips. The internet is also a rich source of information on this subject. Seek and you shall find.

Your initial involvement with the Proteus VX will most likely consist of playing the existing bank and presets. While our factory presets are very good, there are probably some things you would like to change, perhaps the LFO speed, the filter setting, or the attack time. Eventually, you might want to make your own presets.

Editing Presets

It's easy to create new presets by modifying the controller settings. This is really the best way of getting acquainted with the Proteus VX. If you don't like the results, simply reload the preset or bank and you'll be back to the original sound. The raw samples in Proteus VX cannot be changed, so they'll always be available.

► To Edit a Preset

1. In the Tree, **click on the Preset Icon** of the preset you want to edit.
2. The **Initial Controller Amounts** are saved when you save the bank. **Start here.**
3. The **Preset FX** can be edited and saved with the bank.
4. The **Preset Cords** can also be edited. These cords are quite useful for controlling the Preset FX via MIDI controllers. The available FX parameters depend on which Preset FX you have selected. The **Volume**, **Transpose** and the **Tuning Table** can be edited and saved.
 - **Note:** The **Poly Timer** and **Channel Ramp** are NOT used in any of the Proteus X Composer presets and so these controls have no effect on the sound.

▼ Adding Preset Effects uses CPU cycles. If a preset is used by multiple MIDI channels and you add Preset FX, the CPU penalty is multiplied for each channel that uses the preset.

Changes are not permanent until you SAVE a bank. Therefore, you can experiment all you want with presets without worrying about losing a sound. **Tip when Saving** - Select **Save As...** and use a different name to avoid overwriting the factory Proteus X Composer bank.

Modulation

Modulation means to dynamically change a parameter, whether it be the volume (amplitude modulation), the pitch (frequency modulation), or whatever. Turning the volume control on your home stereo rapidly back and forth would be an example of amplitude modulation. To modulate something we need a modulation source and a modulation destination. The source is your hand turning the knob, and the destination is the volume control. If we had a device that would automatically turn the volume control, we would also call that device a modulation source.

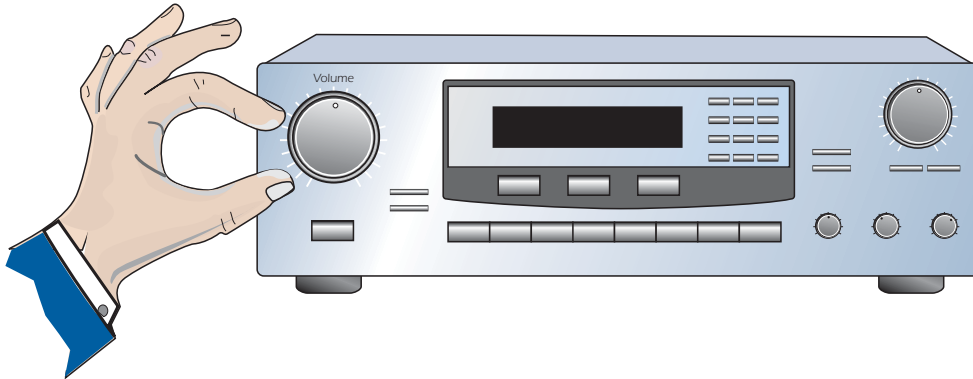

Turning the volume control back and forth on your home stereo is an example of Amplitude Modulation.

The Proteus VX is designed so that for each of the variable parameters, such as the volume, there is an initial setting which can be changed by a modulation source. Therefore in the case of volume, we have an initial volume and we can change or modulate that volume with a modulation source. Positive modulation *Adds* to the initial amount. Negative modulation *Subtracts* from the initial amount.

Modulation Sources

The main modulation sources are Envelope Generators, Performance Controllers and Low Frequency Oscillators. In the previous example, an envelope generator could be routed to automatically turn the volume control as programmed by the envelope, or, a low frequency oscillator could be routed to turn the volume control up and down in a repeating fashion. The main mod sources are listed below.

Keyboard Key

Which key is pressed.

Key Velocity

How fast the key is pressed.

Release Velocity

How fast the key is released.

Gate

High if the key is pressed, low when the key is released.

Key Glide

A smoothly changing control source based on the Glide Rate and the interval between the last two notes played.

Pitch and Mod Wheels

Keyboard pitch bend and modulation wheels.

Keyboard Pressure (mono aftertouch)

Key Pressure applied after the key is initially pressed.

Pedal

A continuously variable pedal controller connected to your MIDI keyboard.

Miscellaneous Controllers A -P

Any type of MIDI continuous controller data from your keyboard or other controller. MIDI continuous controller numbers are programmed in the Preferences dialog box (See [page 22](#)).

Low Frequency Oscillators (2 per voice)

Generate moving, repeating waves used to add interest and animation to the sound.

Envelope Generators (3 per voice)

Generate a programmable "contour" which changes over time when a key is pressed.

Function Generators (3 per voice)

A programmable, stepped modulation source which can be used as a complex LFO, a sequencer or an arpeggiator depending on how it is utilized.

Noise & Random Generators

Generate spectrums of noise and random signals to be used for modulation.

T-switch and Footswitches

Change a parameter when a MIDI switch is pressed. MIDI footswitch numbers are programmed in the Preferences dialog box (See [page 22](#)).

Modulation Cords

You use a Cord to connect a modulation Source to a Destination. (Patchcord – a holdover from the days when modules of an analog synthesizer were connected together with physical cords. Nowadays, we still need a way to connect modules together, so the cords are implemented in software.)

Modulation sources can be connected to the modulation destinations in almost any possible way. The cords themselves can even be modulated. Each cord has an amount parameter which determines "how much" modulation is applied to the destination. The modulation amount can be positive or negative and will either add or subtract from the initial value.

To use a modulation cord, you must connect a modulation Source to a modulation Destination. Think of modulation cords as if you are connecting an actual cord. You must connect both ends of the cord for the connection to be made. There are 36 general purpose cords per voice.

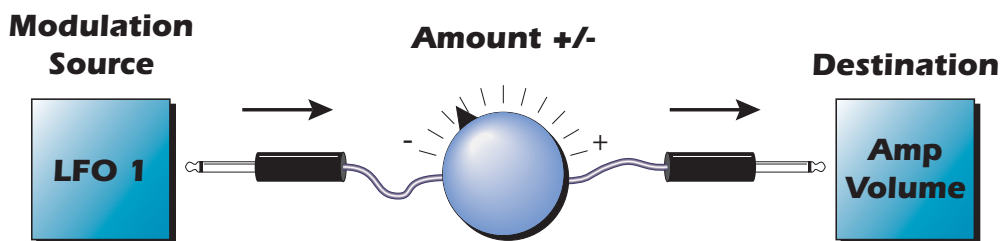

Envelope Generators

An envelope can be described as a “contour” which can be used to shape the sound in some way over time. There are three envelope generators per voice and all of them are the rate/level type.

This is how the rate/level envelopes work: When a key is pressed, envelope starts from zero and moves toward the Attack 1 Level at the Attack 1 Rate. As soon as it reaches this first stage, it immediately begins the Attack 2 phase and moves toward the Attack 2 level at the Attack 2 rate. As long as the key is still held, the envelope continues on through the Decay 1 and Decay 2 stages. If the key is still held when the envelope reaches the end of Decay 2, it simply stops there waiting for you to release the key. When you release the key, the envelope continues through its Release 1 and Release 2 stages, stopping at the end of the Release 2 stage. The rate/level envelopes give maximum flexibility to program both complex and simple envelopes.

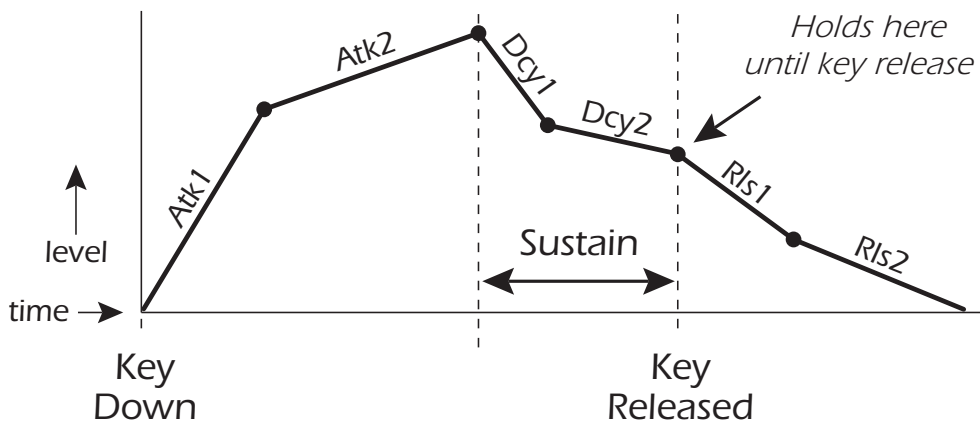

- The EOS envelope generators are just like standard ADSR's, except that they have two segments for each stage.

To create a standard ADSR curve, set the “2” levels the same as the “1” levels and set all the “2” rates to 0.

The Amplifier Envelope generator controls the volume of the voice over time and has 6 stages: Attack 1, Attack 2, Decay 1, Decay 2, Release 1 and Release 2. The Filter Envelope generator controls the filter morph and also has 6 stages. Unlike the amplifier envelope, however, the filter envelope has the ability to go negative as well as positive. There is also an Auxiliary Envelope generator which is a general purpose envelope. The auxiliary envelope is identical to the filter envelope and can go negative as well as positive. The time of each stage can be adjusted to create myriad envelope shapes, which in turn shape the sound over time.

The way the volume of a sound changes over time determines how we perceive that sound. For example, a bell struck with a hammer is instantly at full volume, then slowly dies away. A bowed violin sound fades in more slowly and dies away slowly. Using the Amplifier Envelope, you can simulate different types of instrument volume envelopes by programming them appropriately.

Retriggering

The Filter and Auxiliary envelopes can be retriggered by an LFO or any other modulation source such as clock divisor. ([See “Clock Modulation” on page 108.](#)) Patch the desired modulation source (using a positive value) to Filter Env Trigger or Aux Env Trigger. Envelopes are triggered on a positive-going edge.

Complete Mode

In Complete mode, the envelope generator continues through all six stages when a key is pressed, ignoring the status of key sustain. This feature allows you to create long evolving soundscapes with a quick tap of the key, enveloping percussive sounds such as piano and drums, or plucked strings. This mode is also useful to conserve CPU resources, since the voice will turn off as soon as the amp envelope cycle completes.

Low Frequency Oscillators (LFOs)

A Low Frequency Oscillator or LFO is simply a wave which repeats at a slow rate. The Proteus has two multi-wave LFOs for each channel. The LFO waveforms are shown in the following illustration.

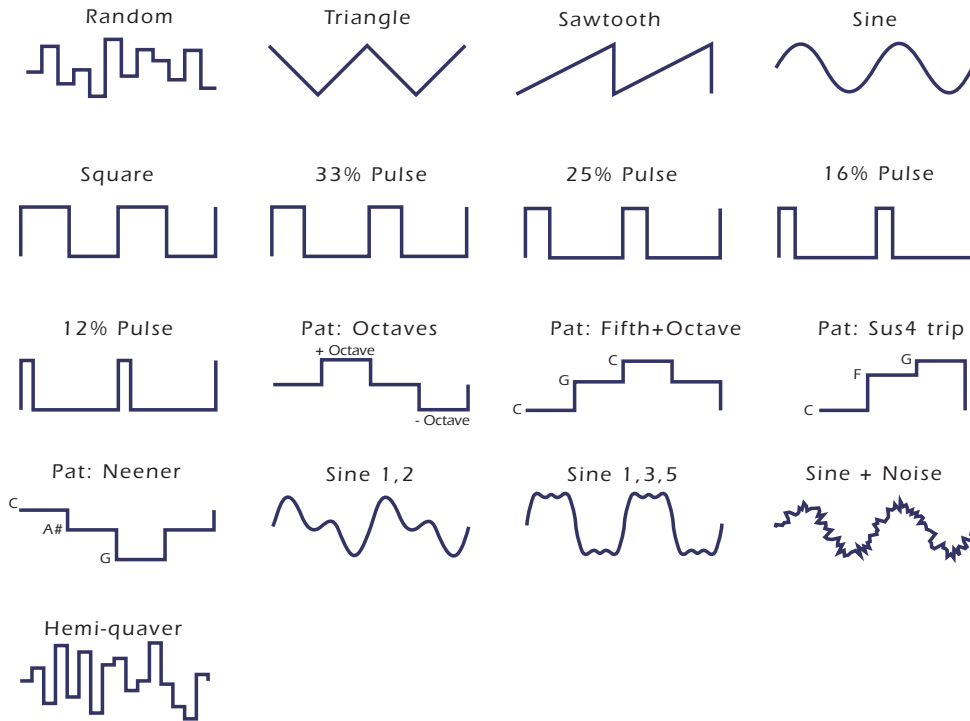

By examining the diagram of the LFO waveforms, you can see how the LFO will affect a modulation destination. Suppose we are modulating the pitch of an instrument. The sine wave looks smooth, and will smoothly change the pitch. The square wave changes abruptly, and will abruptly change the pitch from one pitch to another. The sawtooth wave smoothly decreases, then abruptly changes back up. The sound's pitch will follow the same course. Controlling the pitch of an instrument is an easy way to hear the effects of the LFO waves.

◆ Try combining the Pattern LFOs, or controlling the amount of one with another, or combining them with the clock divisors.

Like the Auxiliary Envelope, the LFOs can be routed to control any real-time functions such as Pitch, Filter, Panning, or Volume. A common use for the LFO is to control the pitch of the sound (LFO -> Pitch). This effect is called vibrato and is an important performance parameter. Many presets use this routing with the modulation wheel controlling "how much" LFO modulation is applied. Another common effect, Tremolo, is created by controlling the volume of a sound with the LFO (LFO -> Volume).

Another use for the LFOs might be to add a slight bit of animation to the sound by routing the LFO to control the filter. In this example, the LFO amount would be set low, for a subtle effect.

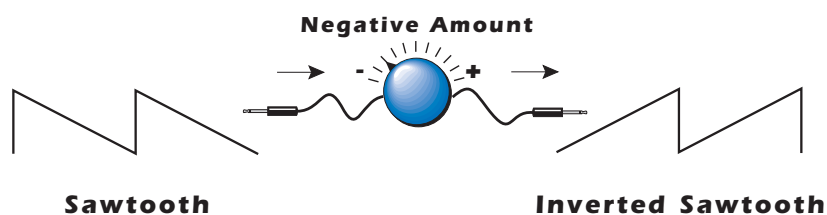

When the amount of an LFO is a negative value, the LFO shape will be inverted. For example, inverting the sawtooth wave produces a wave that smoothly increases, then instantly resets down. Since the inverted sawtooth wave is now negative, adding DC with a cord amount of +100 will make it positive again.

Random Sources

Random modulation sources can be used when you want the timbre of the sound to be “animated” in a random or non-consistent manner.

Key Random 1 & 2 generate different random values for each voice which are selected at key-on time and do not change during the note.

The **White & Pink Noise** Generators produce varying random values. Both white and pink noise sources are low frequency noise designed for control purposes. Either noise source can be filtered even more by passing it through a lag processor.

The **Crossfade Random** function generates the same random value for all voices in a preset. This source is designed to be used for randomly crossfading voices, although you may find other uses.

Clock Modulation

The clock can also be used as a modulation source. It can be used to trigger the Filter or Auxiliary envelope generators, trigger sample start, synchronize the LFOs, or used directly as a square wave modulation source. Envelopes are triggered on the positive going edge of the clock. LFOs are triggered on the negative going edge.

The Clock source is available in six divisions (double whole note, whole note, half note, quarter note, eighth note, sixteenth note). The different rates can be used separately or in conjunction to create complex “synchro-sonic” rhythm patterns.

Using MIDI clocks, the internal clock can also be synchronized with an external MIDI device such as a drum machine or sequencer.

Clocks are routed exactly like the other modulations sources using the Cords. The Cord Amount **MUST** be positive (+) for the clock to pass. By modulating the Cord Amount, the divided clocks can be routed around using real-time controllers or other modulation sources.

Syncing an LFO to the Clock

When an LFO is triggered by a clock, the LFO wave resets to zero every time the clock wave goes low. To sync an LFO to the clock, patch a clock divisor to the LFO Trigger (Trg) in the Cords screen.

If the LFO rate is close to the clock rate, **the LFO will synchronize with the clock**. If the two rates are far apart, the waveform of the LFO will be mildly or radically altered (as shown by the diagram on the following page).

The possibilities of clock modulation and retrigger are numerous. A repeating six segment curve of any shape can be created by triggering the Filter or Auxiliary Envelope generators with the clock. A few other possibilities are listed below.

- Turn different voice layers on and off using different clock divisors.
- Create a global triangle LFO by routing the Clock through a Lag Processor.
- Switch between Auxiliary and Filter Envelope retriggering using a slider or footswitch.

◆ Envelopes are triggered on the positive going edge of the clock. LFOs are triggered on the negative going edge of the clock.

◆ The tempo of the master clock is set from the Multisetup page.

- Turn different voice layers on and off using different clock divisors.
- Retrigger LFOs or Envelopes using noise or other LFOs to create random or semi random effects.
- Modulating the rate of triggered LFOs will alter the LFO waveform.
- Route multiple clocks with different divisors to the same destination (such as pitch) to create complex patterns. (Hint: Adjust the Cord Amounts.)

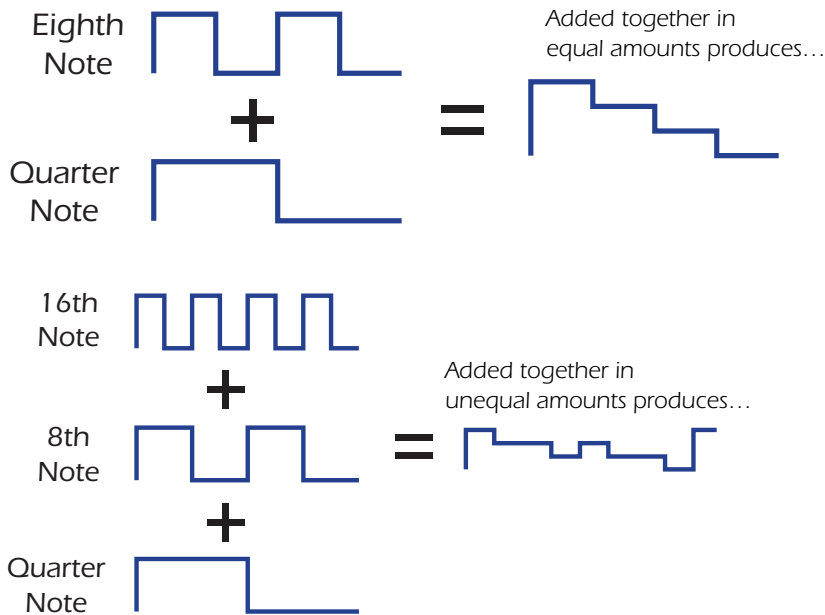

Function Generators

The function generators are multi-function modulation sources, which can be used as complex LFOs, sequencers, arpeggiators, or envelope generators. Each voice has three independent function generators. The function generator outputs a stepped (or smooth) sequence of values and a gate/trigger for each step.

Its most obvious function is as a step-sequencer/arpeggiator (when controlling pitch), or as a complex event generator for the filter or amplifier. Several key sync and direction modes allow you to create interesting variations and complex levels of control. The gate and trigger outputs can trigger envelope generators, retrigger samples or LFOs, accent certain notes, change tempo, and trigger other events.



Modulation Destinations

The Cords section of the Preset Edit page is where modulation sources are connected to destinations. Each cord has an amount control associated with it to control how much modulation is applied.

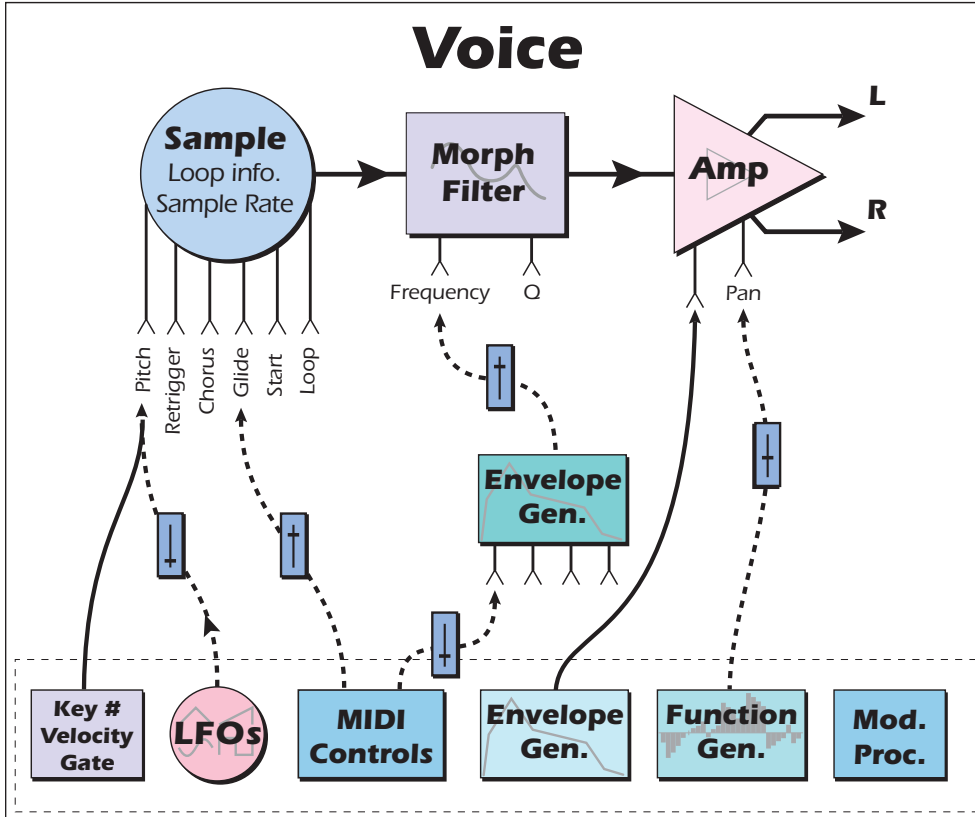

The Cords screen and the diagram above show how modulation sources are connected to destinations. The modulation sources can control any of the destinations in the voice.

Note-on modulation sources, such as key, velocity and gate output a single value at note-on time. real-time modulation sources such as LFOs, envelope generators and modulation wheels can be varied continuously.

The possible modulation routings are completely flexible as shown in the diagram above. Multiple sources can control the same destination, or a single source can control multiple destinations.

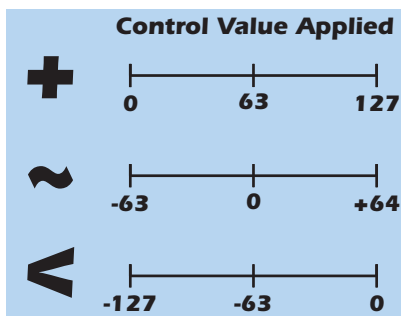

+ modulation ADDS to the initial value. (Normal)

~ centers around Zero. (Use for LFOs, Filt. Freq.)

< modulation SUBTRACTS from the initial value

Modulation Processors

Modulation processors are devices which can modify modulation sources such as LFOs and envelope generators before they are applied to a destination. The modulation processors allow you to create patches and do tricks which would not be possible otherwise. The following modulation processors are currently implemented:

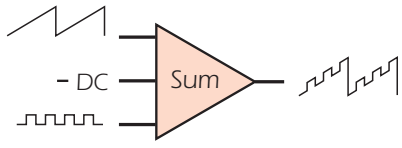
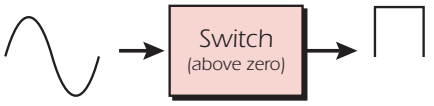
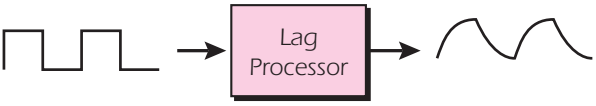
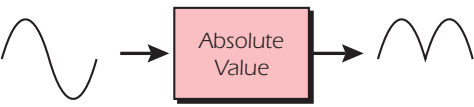
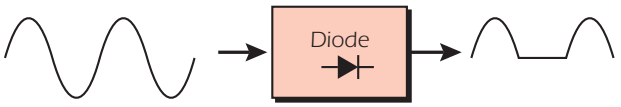
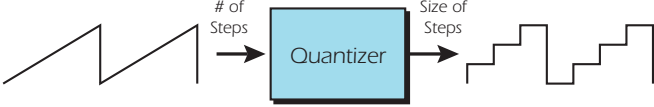
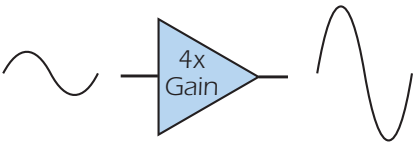
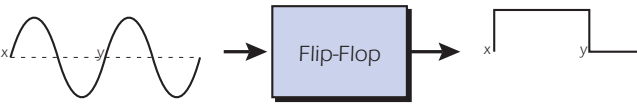
<p>Summing Amp Allows you to add several modulation sources so the output can be controlled by a single Cord Amount.</p>	
<p>Switch Outputs a full value (100) level whenever the input is greater than zero.</p>	
<p>Lag Processors Slow down rapid changes in the input signal. The output "lags" behind the input. Rate is adjustable.</p>	
<p>Absolute Value Inverts negative values and leaves positive values untouched. Outputs only positive values.</p>	
<p>Diode Blocks negative values and allows positive values to pass untouched.</p>	
<p>Quantizer With the input Cord set to 100% the output is limited to 16 discrete steps.</p>	
<p>4x Gain This processor multiplies the input value by a factor of four. Used to amplify modulation sources.</p>	
<p>Flip-Flop Alternates between full value (100) and 0 each time the input goes positive through zero.</p>	

Dynamic Filters

Following is a block diagram of the signal path.

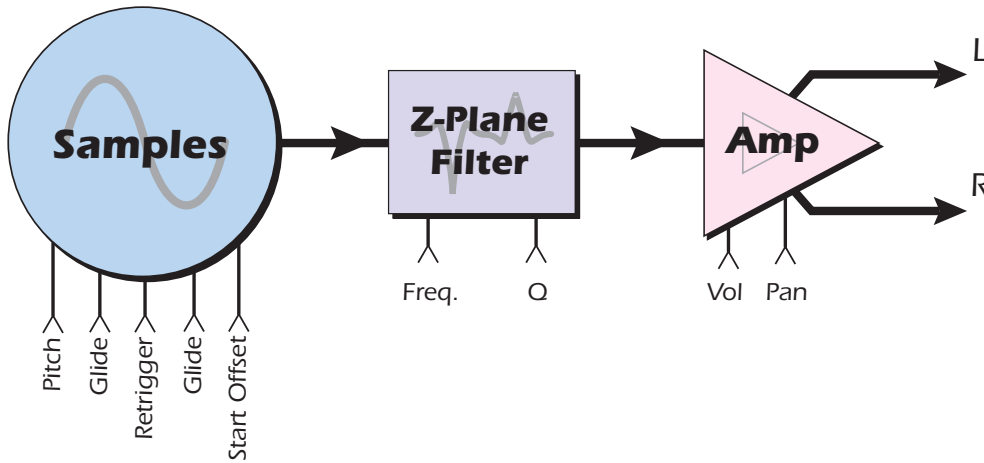

The Proteus VX utilizes advanced Z-plane filters which can dramatically alter the sound of a sample.

To understand how a filter works, we need to understand what makes a sound wave. A sine wave is the simplest form of sound wave. Any waveform except a sine wave can be analyzed as a mixture of sine waves.

One way to represent complex waveforms is to use a chart with frequency on one axis and amplitude on the other. Each vertical line of the chart represents one sine wave at a specific amplitude and frequency.

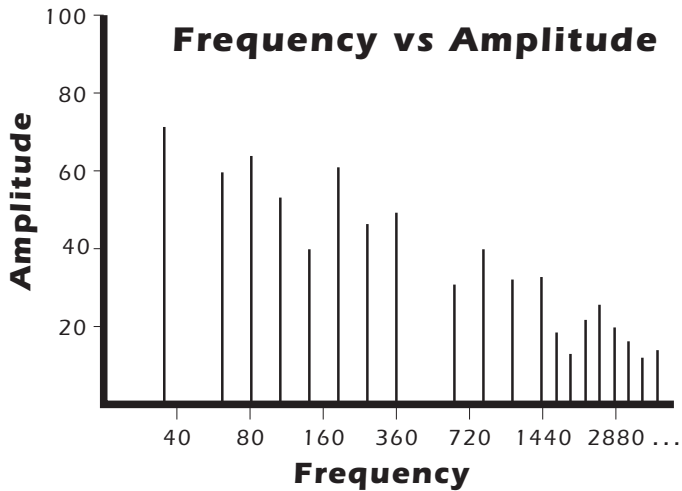

What is a Filter?

Most samples are complex waves containing many sine waves of various amplitudes and frequencies. A filter is a device which allows us to remove certain components of a sound depending on its frequency. For example, a Low Pass Filter lets the *low frequencies pass* and removes only the high frequencies.

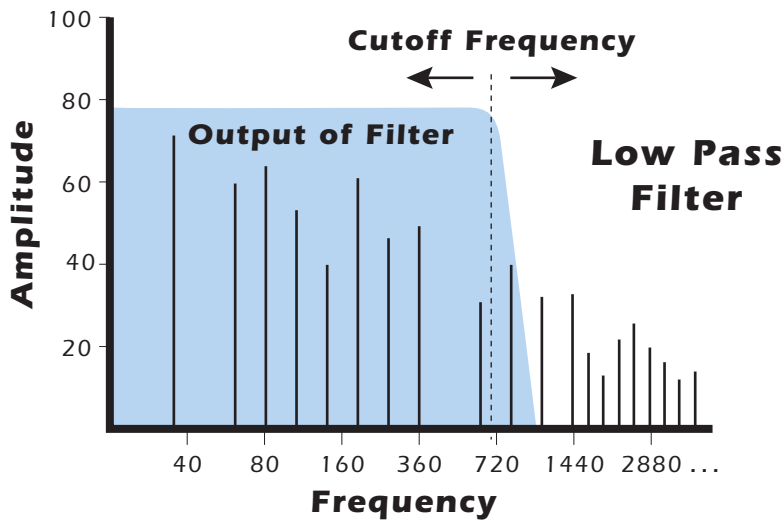

A filter that lets only the high frequencies pass is called a high-pass filter.

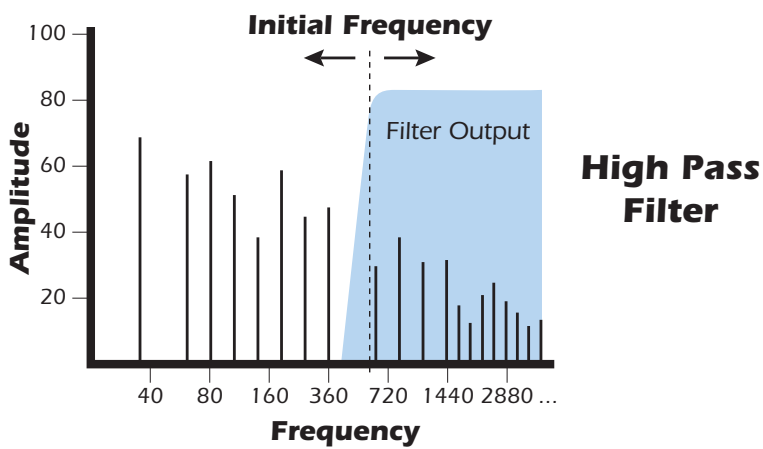

A filter that only lets a certain band of frequencies pass is called a band-pass filter.

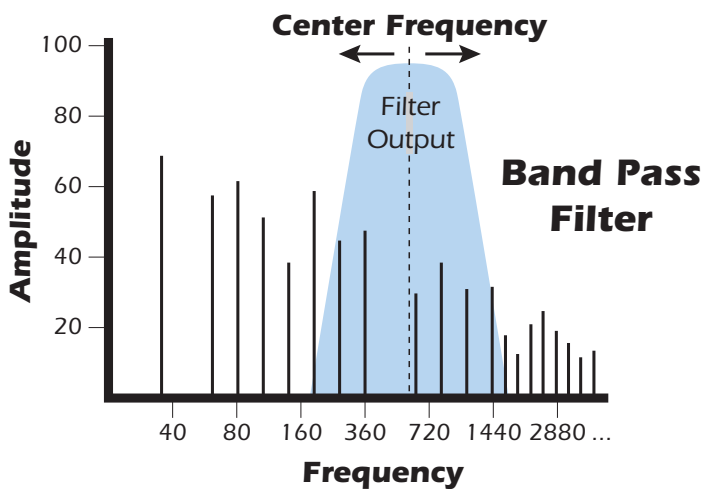

A Notch Filter is just the opposite of a bandpass filter and is used to eliminate a narrow band of frequencies.

Another control found on traditional filters is called Q or resonance. A lowpass filter with a high Q would emphasize the frequencies around the cutoff frequency. The following chart shows how different amounts of Q affect the low pass filter response. In terms of sound, frequencies around the cutoff tend to “ring” with high Q settings. If the filter is slowly swept back and forth, with a high Q, various overtones are “picked out” of the sound and amplified as the resonant peak sweeps over them. Bells and gongs are real world examples of sounds which have a high Q.

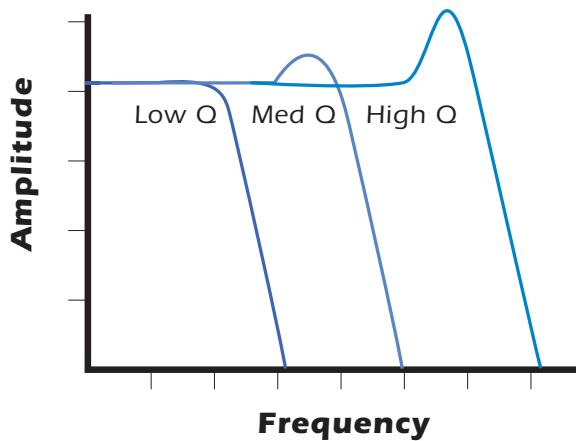

Another characteristic of a filter is the number of poles it contains. Traditional synthesizer filters were usually either 2-pole or 4-pole filters. The Proteus has a selectable 2, 4 or 6-pole low pass filter. The number of poles in a filter describes the steepness of its slope. The more poles, the steeper the filter's slope and the stronger the filtering action. The tone controls on your home stereo are probably one-pole or two-pole filters. Parametric equalizers are usually either two-pole or three-pole filters. In terms of vintage synthesizers, Moog and ARP synthesizers used 4-pole filters. Oberheim and E-mu synthesizers were famous for their 2-pole filter sound.

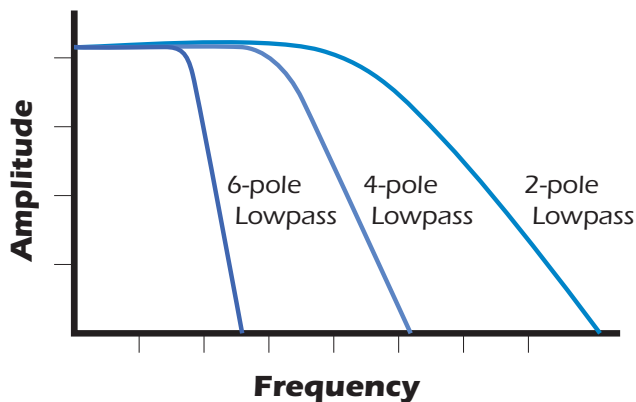

Using a filter, we now have a way to control the harmonic content of a sampled sound. As it turns out, even a simple low pass filter can simulate the response of many natural sounds.

For example, when a piano string is struck by its hammer, there are initially a lot of high frequencies present. If the same note is played softer, there will be fewer of the high frequencies generated by the string. We can simulate this effect by routing keyboard velocity to control the low pass filter. The result is expressive, natural control over the sound.

If an envelope generator is used to control the cutoff frequency of a filter, the frequency content can be varied dynamically over the course of the note. This can add animation to the sound as well as simulate the response of many natural instruments.

Parametric Filters

A more complex type of filter is called a parametric filter or Swept EQ. A parametric filter allows control over three basic parameters of the filter. The three parameters are: Frequency, Bandwidth, and Gain. The Frequency parameter allows you to select a range of frequencies to be boosted or cut, the Bandwidth parameter allows you to select the width of the range, and the Gain parameter either boosts or cuts the frequencies within the selected band by a specified amount. Frequencies not included in the selected band are left unaltered. This is different from a band pass filter which attenuates (reduces) frequencies outside the selected band.

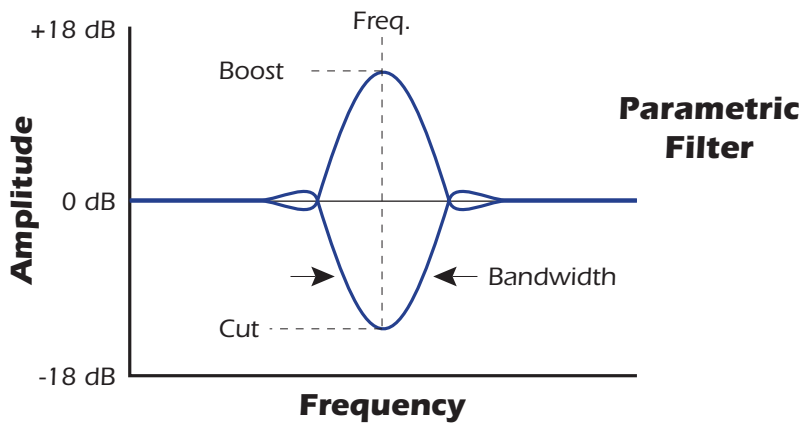

Another parameter sometimes used on a parametric filter is Shelving. Shelving simply widens the passband so that it extends to the limit of the upper or lower frequency range.

The parametric filter is quite flexible. Any range of frequencies can be either amplified or attenuated. Several parametric sections are often cascaded in order to create complex filter response curves.

If four parametric filter sections were cascaded, it would be possible to create the following complex filter response.

4 Parametric Equalizers

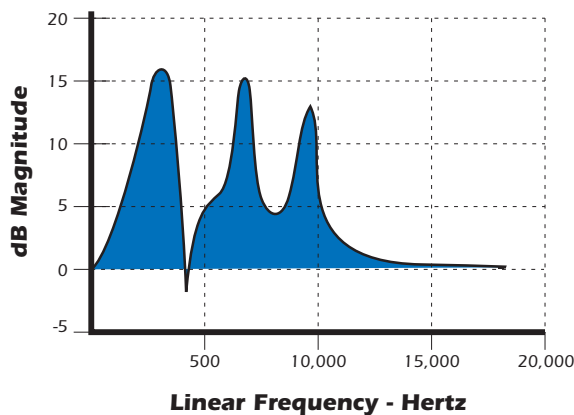

Many natural instruments have complex resonances which are based on their sound-board or tube size. The resonance shown above would be impossible to create using a normal synthesizer filter.

The Z-Plane Filter

A Z-plane filter is a filter which can change its function over time. In a Z-plane filter, we start with two complex filter types and interpolate between them using a single parameter. Refer to the diagram below.

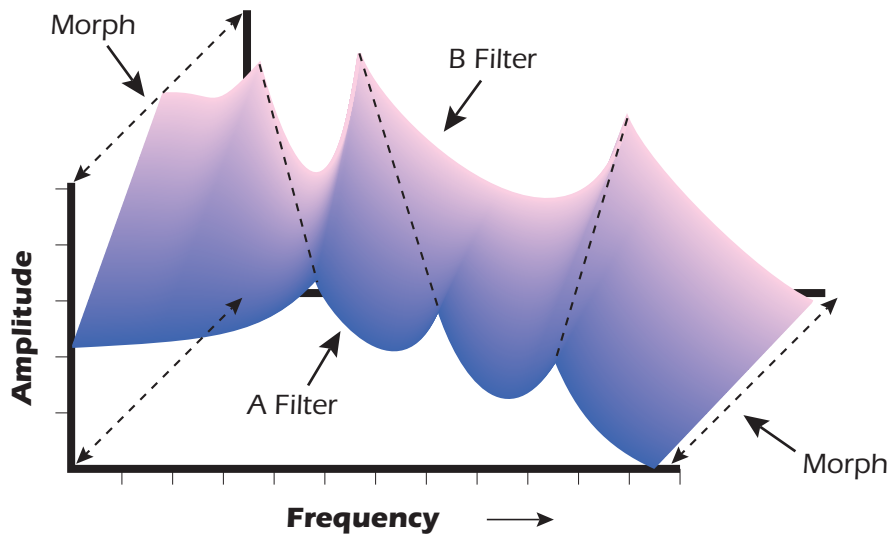

The Z-plane filter has the unique ability to change its function over time.

Filters A and B represent two different complex filters or "frames". By changing a single parameter, the Morph, many complex filter parameters can now be changed simultaneously. Following along the Morph axis you can see that the filter response smoothly interpolates between the two filters. This is the essence of the Z-plane filter. Through the use of *interpolation*, many complex parameters are condensed down into one manageable entity.

Consider, as an example, the human vocal tract, which is a type of complex filter or resonator. There are dozens of different muscles controlling the shape of the vocal tract. When speaking, however, we don't think of the muscles, we just remember how it feels to form the vowels. A vowel is really a configuration of many muscles, but we consider it a single object. In changing from one vowel to another, we don't need to consider the frequencies of the resonant peaks! You remember the shape of your mouth for each sound and interpolate between them. This is similar to what the Z-plane filter does.

This Z-plane filter sweep can be controlled by an envelope generator, an LFO, modulation wheels or pedals, keyboard velocity, key pressure, etc. In fact, any of the modulation sources can control the Z-plane filter.

MIDI Channels & Real-time Controls

The MIDI real-time controllers may seem confusing at first, but they are really very simple once you understand them. You probably already know that there are 16 MIDI channels per MIDI cable. Each MIDI channel uses three basic types of messages; note on/off, preset changes, and continuous controller messages. Your MIDI keyboard, in addition to telling Proteus VX which note was played, can also send aftertouch real-time control information, which simply means control occurring in real-time or "live." (You may be using a MIDI device other than a keyboard, but for simplicity's sake we'll presume that you are using a keyboard.) Real-time control sources include such things as controller knobs, pitch wheels or touchstrips, modulation wheels, control pedals and aftertouch. These are used to add more expression or control.

The controller knobs send out real-time controller information on separate continuous controller numbers. There is a set of 128 continuous controller numbers for each MIDI channel. Some continuous controllers, such as modulation wheel, volume, and pan have standardized numbers. For example, volume is usually sent on continuous controller #7. The controller knobs are programmed to specific MIDI controls.

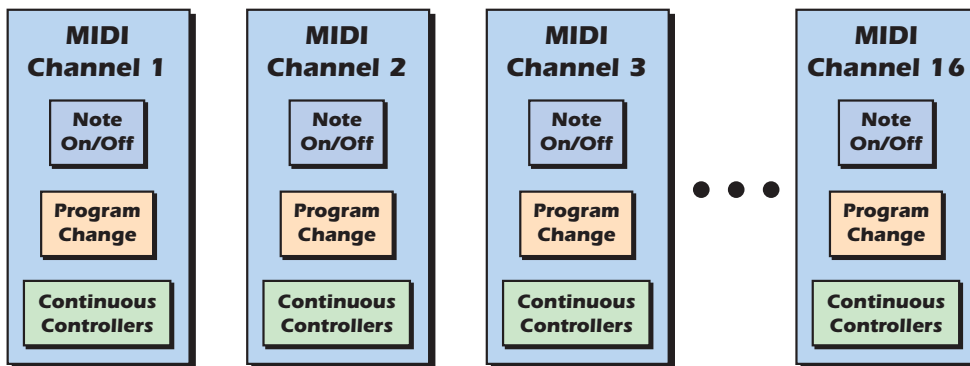

Any MIDI controller can be routed to any modulation destination. First, you have to know which controller numbers your keyboard transmits. Most modern MIDI keyboards let you select a controller number for each control on the keyboard. For example, it may let you select a number from 0-31 for the data slider. The real-time controller numbers that the keyboard transmits must match the numbers Proteus VX is receiving, otherwise nothing will happen when you move the controls.

Suppose you wanted to send the four data sliders on your master keyboard. Proteus VX can handle up to 16 MIDI controllers (A-P) of your choosing. "MIDI A-P" are simply names for the internal connections that link external MIDI continuous controllers to the Cords page. There are two parts to the connection. First, MIDI controller numbers are assigned to the letters A-P in the Controllers dialog box. Next, the letters A-P are connected to synthesizer control parameters in the PatchCord section of the Preset Edit window. The Cord Amount scales the amount of each controller by a positive or negative value.

Most factory presets have the MIDI A-P controls connected to standard synthesizer functions (labelled in the Multisetup page). By choosing any four of the 16 standard functions, the four sliders on your keyboard will work the same on every preset. The chart on the following page shows how this might work if your keyboard transmitted the slider settings on MIDI controllers 21-24.

Control	MIDI Controller #	Routing Letter	Standard Function
Slider 1	21	A	Controls Filter Frequency
Slider 2	22	B	Controls Filter Resonance
Slider 3	23	C	Controls Filter Attack
Slider 4	24	D	Controls Filter Decay

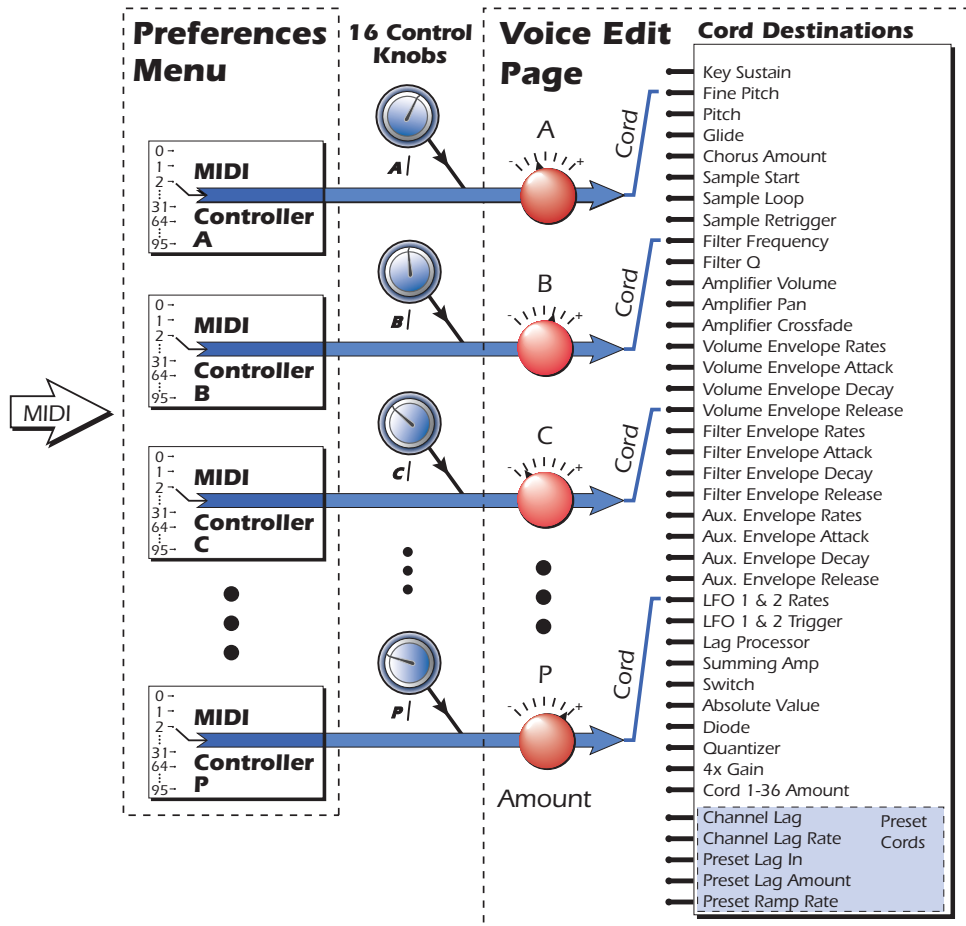

MIDI A-P are internal connections which carry MIDI continuous controller data. MIDI Continuous Controller numbers are assigned to a letter (A-P) in the Preferences menu, then assigned to the same letter to a modulation destination in the Voice Editor page. In Proteus VX the voice editing destinations are pre-programmed, but the MIDI controller inputs in the Preferences menu are user-assignable.

MIDI Program Change Commands

The Proteus VX receives MIDI Program Change commands on each of its 16 MIDI channels. MIDI program changes select Proteus VX *Presets*. The “Receive Program Changes” button must be turned on (depressed) in the Preferences dialog box in order to receive program changes or bank select commands.

MIDI Bank Select Commands

The Proteus VX accepts MIDI bank select commands using MIDI continuous controller numbers. Continuous Controller (CC) 0 is the MSB (most significant byte) and CC 32 is the LSB (least significant byte). Normally you send both the MSB and LSB controllers to implement a bank change.

Proteus VX remembers the MSB and the LSB that were last sent. For example, if you have already set the Bank MSB to 04, you need only send the LSB to change banks within the bank.

The selected bank remains selected until you change it (either via MIDI or by changing the bank from the display). Standard MIDI Program Change commands select from 128 presets within the selected bank.

Background: Bank Select Commands

When the original MIDI specification was developed, no commercially available synthesizer had more than about 100 preset locations. At that time being able to select up to 128 presets didn't seem like much of a limitation. So it was that the original MIDI specification provided for the selection of up to 128 presets.

Musicians wanted *more* presets and so the MIDI specification was later amended to include *Bank Select Commands*. It was decided that Bank Select Commands would use Continuous Controllers 0 and 32 to allow the selection of up to 16,384 banks of 128 presets (over two million presets).

Because Bank Selects are implemented using Continuous Controllers, the Bank Selections can be made *per channel*. (This is getting better and better.) For each MIDI channel, you can select any of 16,384 banks and then one of the 128 presets in the bank. Of course no synthesizer has 16,384 banks (yet), but hey, it's nice to know it's possible (for that really BIG project).

MIDI Modes

There are three MIDI modes used by the Proteus VX. Multi Mode is the default mode. Select MIDI Modes from the toolbar buttons or from the Taskbar, Options menu.

- **Omni Mode** Voice messages are received on any and all MIDI channels and played on the current channel. This mode is the lowest common denominator of MIDI. It is designed so that you always hear something. Also called “Mode 1”.
- **Poly Mode** Voice messages are received only on one MIDI channel (the current MIDI channel). Also called “Mode 3”.
- **Multi Mode** Voice messages on each MIDI channel play on the preset assigned to that channel. The Proteus VX has the ability to play a different preset on each of 16 MIDI channels.

The **Current MIDI Channel** can be identified by the yellow channel number in the Multi page. Click on any channel number to make it the current channel.

■ **Tip:** Select “Show Bank and Program Numbers” in the toolbar to view program and bank numbers in the preset list.

■ Bank and Program numbers are displayed in Single Preset mode screen.

◆ The general term for “Preset” in MIDI-speak is “Program”. Same thing.

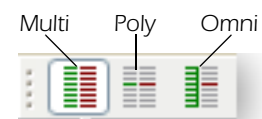

8 - Appendix

Keyboard Shortcuts

File Menu

New Ctrl + N
 Open Ctrl + O
 Merge Ctrl + M
 Save Ctrl + S

Edit Menu

Undo Ctrl + Z
 Redo Ctrl + Y
 Cut Ctrl + X
 Copy Ctrl + C
 Paste Ctrl + V
 Select All Ctrl + A

Options

All Sound Off Ctrl + Pause

Window

Close Alt + F4
 Tile Horizontally Ctrl + Shift + H
 Tile Vertically Ctrl + Shift + V

Presets

New Preset Ctrl + W

View

Refresh F5

Right Click Shortcuts

Use the right mouse button to call up a popup window with these context-sensitive shortcuts.

On Instrument (Proteus VX icon)

Open Bank Ctrl + O
 Merge Ctrl + M
 Save As
 Preferences

On Preset Icon (tree)

Open in New Window
 Rename F2
 Cut Ctrl + X
 Copy Ctrl + C
 Paste Ctrl + V
 Delete Del
 Duplicate Ctrl + U
 Category
 Export (*as new bank*)
 Select on Current Channel Ctrl + P

Numeric Field

Undo
 Cut
 Copy
 Paste
 Delete
 Select All

Toolbars

Checkboxes for Tools view: Status, Standard, Toolbars
 Dialog

Multisetup Icon (in tree)

Open in New Window
 New Ctrl + W

Toolbar Functions

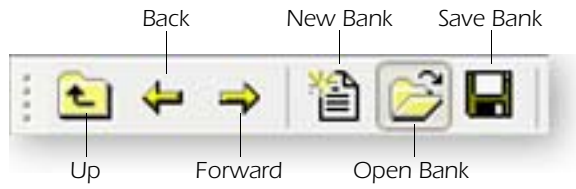

MIDI Modes

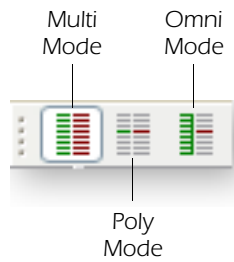

Display Items

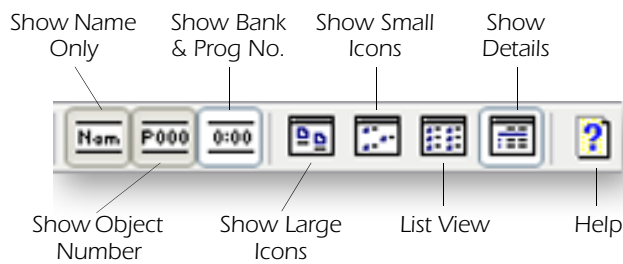

Status Bar

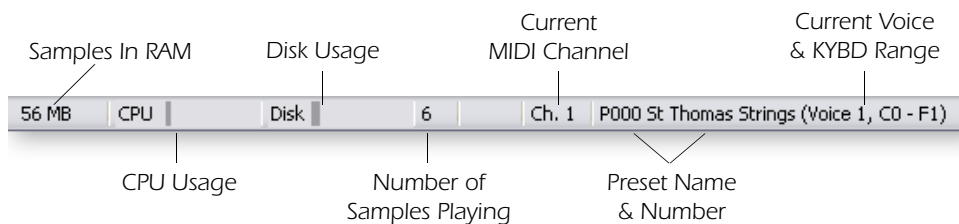

MIDI Implementation Chart

MIDI Information	Transmitted	Recognized	Remarks
MIDI Channels	No	1-16	16 MIDI Channels
Note Numbers	No	0-127	
Program Change	No	0-127	
Bank Select Response?	No	Yes	MSB + LSB
Modes: Omni (<i>Mode 1</i>)	No	No	Responds to all MIDI channels
Mono (<i>Mode 2</i>)	No	No	
Poly (<i>Mode 3</i>)	No	No	
Mode 4 (<i>Y/N</i>)	No	No	
Multi (<i>Mode 5</i>)	No	No	
Note On Velocity	No	Yes	
Note Off Velocity	No	Yes	
Channel Aftertouch	No	Yes	
Poly (Key) Aftertouch	No	No	
Pitch Bend	No	Yes	
Active Sensing	No	No	
System Reset	No	No	
Tune Request	No	No	
System Exclusive	No	No	
Sample Dump Standard	No	No	
File Dump	No	No	
MIDI Tuning	No	No	
Master Volume	No	No	
Master Balance	No	No	
Notation Information	No	No	
Turn GM1 System On	No	No	
Turn GM2 System On	No	No	
Turn GM1 System Off	No	No	
Other (<i>See Remarks</i>)	No	No	
NRPNS	No	No	
RPN 00 (<i>Pitch Bend Sensi.</i>)	No	No	
RPN 01 (<i>Chan. Fine Tune</i>)	No	No	
RPN 02 (<i>Chan Coar. Tune</i>)	No	No	
RPN 03 (<i>Tuning Prog Sel.</i>)	No	No	
RPN 04 (<i>Tuning Bank Sel.</i>)	No	No	
RPN 05 (<i>Mod Depth Rang</i>)	No	No	
MIDI Timing & Sync	No	No	
MIDI Clock	Yes	Yes	
Song Position Pointer	No	No	
Song Select	No	No	
Start	No	No	
Continue	No	No	
Stop	No	No	
MIDI Time Code	No	No	
MIDI Machine Control	No	No	
MIDI Show Control	No	No	
General MIDI Compat?	No	No	
Is GM default mode?	No	No	
DLS compatible?	No	No	
Import DLS Files?	No	No	
Export DLS Files?	No	No	
Import Std MIDI files	No	No	
Export Std MIDI files	No	No	

MIDI Implementation Chart (part 2 - Controllers)

Control #	Function	Transmitted	Recognized	Remarks
0	Bank Select MSB	No	Yes	See Note
1	Mod Wheel MSB	No	Yes	*
2	Breath Cntl MSB	No	No	*
3		No		*
4	Foot Cntl MSB	No	No	*
5	Portamento MSB	No	No	*
6	Data Entry MSB	No	No	*
7	Chan Volume MSB	No	Yes	*
8	Balance MSB	No	No	*
9				*
10	Pan MSB	No	Yes	*
11	Expression MSB	No	Yes	*
12	Effect Cntl 1 MSB	No	No	*
13	Effect Cntl 2 MSB	No	No	*
14				*
15				*
16	GenPur Ctrl 1 MSB			*
17	GenPur Ctrl 2 MSB			*
18	GenPur Ctrl 3 MSB			*
19	GenPur Ctrl 4 MSB			*
20				*
21				*
22				*
23				*
24				*
25				*
26				*
27				*
28				*
29				*
30				*
31				*
32	Bank Select LSB			*
33	Mod Wheel LSB			*
34	Breath Cntl LSB			*
35				*
36	Foot Cntrlr LSB			*
37	Portamento LSB			*
38	Data Entry LSB			*
39	Chan Volume LSB			*
40	Balance LSB			*
41				*
42	Pan LSB			*
43	Expression LSB			*
44	Effect Cntl 1 LSB			*

Control #	Function	Transmitted	Recognized	Remarks
45	Effect Cntl 2 LSB			*
46				*
47				*
48	Gen Pur Ctrl 1 LSB			*
49	Gen Pur Ctrl 2 LSB			*
50	Gen Pur Ctrl 3 LSB			*
51	Gen Pur Ctrl 4 LSB			*
52				*
53				*
54				*
55				*
56				*
57				*
58				*
59				*
60				*
61				*
62				*
63				*
64	Sustain Pedal	No	Yes	*
65	Portamento on/off	No	No	*
66	Sostenuto	No	No	*
67	Soft Pedal			*
68	Legato Footswitch			*
69	Hold 2			*
70	Variation			*
71	Timbre/Har Inten	Yes	Yes	*
72	Release Time	Yes		*
73	Attack Time	Yes		*
74	Brightness	Yes		*
75	Sound Cntrlr 6™	Yes	Yes	*
76	Sound Cntrlr 7			*
77	Sound Cntrlr 8™	Yes	Yes	*
78	Sound Cntrlr 9™	Yes	Yes	*
79	Sound Cntrlr 10	Yes	Yes	*
80	Gen Purp Cntrlr 5	Yes	Yes	*
81	Gen Purp Cntrlr 6			*
82	Gen Pur Ctrl 7™	Yes	Yes	*
83	Gen Pur Ctrl 8™	Yes	Yes	*
84	Portamento Cntrl			*
85				*
86				*
87				*
88				*
89				*
90				*

8 - Appendix
MIDI Implementation Chart

Control #	Function	Transmitted	Recognized	Remarks
91	Effects 1 Depth	Yes		*
92	Effects 2 Depth			*
93	Effects 3 Depth	Yes		*
94	Effects 4 Depth			*
95	Effects 5 Depth			*
96	Data Increment			
97	Data Decrement			
98	NRPN (LSB)			
99	NRPN (MSB)			
100	RPN (LSB)			
101	RPN (MSB)			
102				
103				
104				
105				
106				
107				
108				
109				
110				
111				
112				
113				
114				
115				
116				
117				
118				
119				
120	All Sound Off	No	Yes	See note ✱
121	Reset All Controllers	No	Yes	
122	Local Cntrl on/off	No	No	
123	All Notes Off	No	Yes	
124	Omni Mode Off	No	No	
125	Omni Mode On	No	No	
126	Poly Mode Off	No	No	
127	Poly Mode On	No	No	Poly mode is always on.
<p>NOTES: * Proteus VX can receive ANY continuous controller number from 1 to 95. Because of Proteus VX's powerful synth engine, many of the standard MIDI controllers can be user programmed to provide the desired function. A "Yes" response in this chart means that a controller is programmed by default in Proteus VX.</p> <p>✱ Value of 0 = reset all except vol & pan; value of 127 = reset all.</p> <p>Other: Pan: -64 = hard left, +63 = hard right</p>				

Received Channel Commands

Channels number (n) = 0-15. Message bytes are represented in hex. All other numbers are decimal. Running Status is supported.

Command	Message	Comments
Note Off	8n kk vv	
Note On	9n kk vv	velocity 0 = note off
Key Aftertouch	An kk vv	kk = 0-127 vv = 0-127
Program Change	Cn vv	0-127
Channel Aftertouch	Dn vv	0-127
Pitch Bend	En ll mm	l = lsb, m = msb
Real-time Controller	Bn cc vv	cc = 00-31, 64-95
Footswitch	Bn cc vv	cc = 64-79, vv \geq 64 = on
Volume	Bn 07 vv	0-127
Pan	Bn 0A vv	0=left, 127=right, 64=center
All Sound Off	Bn 78 00	turns all sound off
Reset All Controllers	Bn 79 00	ignored in omni mode
All Notes Off	Bn 7B 00	ignored in omni mode
Omni Mode Off*	Bn 7C 00	forces all notes & controls off
Omni Mode On*	Bn 7D 00	forces all notes & controls off
Mono Mode On (Poly Off)*	Bn 7E 00	forces all notes & controls off
Poly Mode On (Mono Off)*	Bn 7F 00	forces all notes & controls off
Bank Select MSB	Bn 00 bb	bb = bank MSB Go There!
Bank Select LSB	Bn 20 bb	bb = bank LSB Go There!

Special Notes:

- **From Omni Mode** Omni Off turns Poly On.
- **From Poly Mode** Omni On turns Omni On; Mono On turns Mono On.
- **From Mono Mode** Mono Off turns Poly On; Omni On turns Omni On.
- **From Multi Mode** Omni On turns Omni On; Omni Off or Mono Off turns Poly On; Mono On turns Mono On.
All other changes have no effect

Proteus X Composer Bank - MIDI Controller Functions



Controller Functions

- Tone Filter Cutoff
- Presence..... Filter Resonance (Q)
- Shape Amplifier Envelope Decay
- Image Varies According to Preset
(2nd Layer Volume, Sample Start, Chorus, Glide Rate)
- Attack Amplifier Envelope Attack Time
- Dcy/Rel Amplifier Decay & Release Time
- Movement LFO to Panning Amount
- Rate..... LFO 2 Frequency
- Dynamic 1 Velocity Control of Volume
- Dynamic 2 Velocity Control of Filter Frequency (Cutoff)
- Aux 1..... Aux 1 Effects Send Amount
- Aux 2..... Aux 2 Effects Send Amount
- Controller M..... Preset Effect Wet/Dry Mix
- Controller N Preset Effect Parameter (varies according to preset)
- Controller O Preset Effect Parameter (varies according to preset)
- Controller P Preset Effect Parameter (varies according to preset)

Index

Numerics

19-Tone Tuning 54
 1-Band Para EQ 83
 22-Tone Tuning 54
 24-Tone Tuning 54
 2nd Stage Gain 95
 36-Tone Tuning 54
 4-Band EQ 84
 4x Gain 111

A

Absolute Value 111
 Add Input Busses, to Cubase LE 13
 Add Track, Cubase LE 13
 Aftershow
 modulation source 105
 mono 105
 al-Farabi 12, tuning 54
 Alternate Tunings 54
 Amount, patchcord 117
 ASIO Buffer Latency 12
 Audio Setup 19
 Audition
 preset or sample from library 35
 presets 30, 32
 Aux FX 59
 adding 60
 bus routing diagram 43
 enable/disable 61
 select 67
 view buttons 41
 Aux Output 43
 enable/disable 65
 on/off 65
 select 65
 Aux Sends 1-3
 on/off 41

B

Band-Pass Filter 44, 113
 Bank
 & preset display 37
 create new from current multisetup 48
 create new using librarian 35
 structure 33
 Bank Select, MIDI 119

Bias 94
 Bit Depth 12
 setting in Cubase LE 12
 Buffer Latency Setting
 Cubase LE 12
 Buffer Size 19
 Bypass Effects 67

C

Catalog Disks 34
 Category
 preset 29, 38
 tags, adding to samples/presets 35
 Channel Lag Processors 57
 Channel Ramp Processor 58
 Chorus
 effect 75
 Clear Clip Indicators After 10 Seconds 23
 Clear Library 34
 Clipping
 headroom 20
 preventing 42
 Clipping, Proteus VX 15
 Clock
 divisors 109
 master 42
 modulation 108
 Comb Filter 44, 85
 Complete, envelope generator mode 106
 Compression, tube effect 94
 Compressor, effect 77
 Conserving Polyphony
 using envelope complete mode 106
 Context Sensitive Menus 101, 121
 Continuous Controller 117
 Control Panel, E-MU 12
 Controller Knobs
 controlling Proteus VX with 25
 function decoder 128
 Controller Knobs, MIDI keyboard 15
 Controllers
 #7 21
 initial values 52
 MIDI 117
 MIDI #7 117
 MIDI real-time 117
 MIDI setup 22
 modify the sound using 31
 modulate FX using 69
 modulation source 105
 sensitivity 21
 Cords 110
 modulation 105
 preset 58
 CPU Cap 19
 CPU Meter 47

Crossfade Random 108
 Cubase LE
 project window 11
 running Proteus VX in 13
 setting up 11
 Current Channel Indicator 47
 Current MIDI Channel, definition 119
 Current Preset, changing 31
 Curve, velocity 21

D

Damping, high frequency 72
 Decay Time, reverb 72
 Delay, MIDI 25
 Destinations, Modulation 110
 Devices Menu, Cubase LE 11
 Diffusion, reverb 72
 Diode, modulation processor 111
 Distortion
 tube effect 94
 twin effect 95
 Divisors, clock 109
 Drag & Drop 98
 Dynamic 1 & 2 128
 Dynamic Range Adjust 20

E

Early Reflections
 description 72
 effect 83
 Early Reflections Reverb, effect 73
 Echo, creating 79
 Editing Presets 103
 Effect Types
 1-band para EQ 83
 4-band para EQ 84
 chorus 75
 compressor 77
 early reflections 83
 early reflections reverb 73
 flanger 85
 growl 86
 limiter 87
 phase shifter 88
 pitch shifter 89
 reverb 73
 reverb lite 74
 ring modulator 90
 SP12-ulator 91
 tremulator bpm 92
 tube 94
 twin 95
 Effects
 block diagram 62, 63
 bypass 67
 creating robot voice 79

 descriptions 72
 enable/disable 65
 list of 72
 mono delays 79
 post FX sends 68
 preset, adding 61
 selecting preset 41
 typical usage 64
 Envelope Follower, ring modulator 90
 Envelope Generators 105
 description 106
 retriggering 106
 Envelope, reverberation 72
 Equal Temperment Tuning 54
 Expand Tree Items When Selected 23
 Export 48
 multisetup as new bank 48
 External MIDI Clock 21, 42
 External Tempo Source 21, 42

F

Figure Eight, reverb pattern 73, 74
 Filter
 about 112
 bandpass 44, 113
 comb 44
 descriptions 44
 FX
 1-band para eq 83
 4-band eq 84
 global type 44
 highpass 113
 notch 114
 parametric 115
 poles 114
 swept EQ 115
 types 44
 Z-plane 116
 Filter by Category, library 35
 Find, files using the librarian 35
 First Key, modulation 58
 Flanger 85
 Flip-Flop 111
 Footswitch 105
 Function Generator 105, 109
 FX Edit Screen 70
 FX Insert Chains 70

G

Gamelan Tuning 54
 Gate, modulation source 104
 General MIDI Files, playing 25
 Generator
 envelope 105, 106
 noise 105
 Glide, modulation source 104

Global Controls 42
Growl, effect 86

H

Headroom/Boost Control 20
High Frequency Damping, stereo reverb 72
High-Pass Filter 113

I

Image 128
Implementation Chart, MIDI 123, 124
Independent, reverb pattern 73, 74
Initial Controllers A-P 52
Inputs, adding to Cubase LE 13
Installation, software 10
Inverting, modulation sources 108

J

Just C Tuning 54
 description 55
Just Intonation 55

K

Key
 glide, modulation source 104
 velocity, modulation source 104
Key Timer, poly 57
Keyboard
 key, modulation source 104
 pressure modulation source 105
 tuning 54
Kirnberger Tuning 54
Knob Tracking 23

L

Lag Amount, preset lag 57
Lag Processors
 preset 57
 voice 111
Large Icons 100
LFO 105
 flanger 85
 sync 108
 waveforms 107
Librarian 34
Limiter 42
 effect type 87
List View 100
Load Emulator 4 bank 27
Load Last Bank at Startup 23
Low Frequency Oscillator 105, 107

M

Main Output Routing 65
Master Clock 42
Master Transpose 42
Master Tune 42
Master Volume Control 42
Matrix, reverb pattern 73, 74
Merge, library object into the bank 35
Meters, main output 42
MIDI
 bank select commands 119
 cc#7 curve 21
 channel in multisetup 40
 channel, current 29, 31, 39, 40
 continuous controller 117
 continuous controller setup 22
 controller #7 21
 controllers
 function chart 128
 global page 46
 initial settings 52
 controlling effects with 69
 implementation chart 123, 124
 modes, definition 119
 multi mode 119
 omni mode 119
 poly mode 119
 preferences 20
 program change enable/disable 21
 program changes 119
 real-time controllers 117
 selecting input ports 21
 velocity curve 21
MIDI Connection
 Cubase LE 13
MIDI Response 21
MIDI Track
 recording in Cubase LE 15
Mini Keyboard 15
Mod Wheel, modulation source 104
Mode
 mono 127
 multi 127
 omni 127
 poly 127
Modulation
 cords 105
 description 104
 destinations 109
 of effects 69
 processors 111
 source, random 108
 sources 104
Mono Aftertouch 105
Mono Mode 127
Morphing Filters 116

Movement 128
 Multi Mode 119, 127
 Multisetup
 basic operations 48
 export as new bank 48
 intro 28
 MIDI channel 40
 output assignment 40
 saving 48
 selecting 37
 selecting presets 40

N

Network, searching with librarian 34
 Noise Generator 105
 None, in preset select field 31
 Not Set, twistaloo override 41
 Notch Filter 114
 Number of Samples Playing 47
 Numeric Values, entering 98

O

Omni Mode 119, 127
 Optimal Buffer Size 19
 Optimizing your Computer 11
 Outputs. sending MIDI channels to separate 25

P

Pan, in multisetup 40
 Parametric Filter 115
 1-band para eq 83
 4-band eq 84
 PatchCord Amount 117
 Pedal, modulation source 105
 Phase Shifter, effect 88
 Phase Shifter, filter 45
 Phattening, using chorus 75
 Ping Pong 81, 82
 Pitch Shifter, effect 89
 Pitch Wheel 104
 control assignment 22
 Poly Key Timer 57
 Poly Mode, MIDI 119, 127
 Post FX Send Amounts 68
 Pre-Delay 72, 73, 74
 Preferences 18
 Pre-filter 86
 Preroll RAM Indicator 46
 Presence 94, 95, 128
 Preset
 auditioning 30
 changing 29, 30, 38
 cords 58
 editing 103
 selecting from the tree 31

Preset Effects
 adding 61
 enable/disable 41, 62
 modulation 69
 selecting 41, 68
 Preset Global Page 52
 Preset Modulators 56
 Processor
 channel lag 57
 channel ramp 58
 modulation 111
 Program Change
 Cubase LE 16
 Program Change Commands 119
 Project Window, Cubase LE 11
 Proteus X Composer FX Template 66

Q

Q 45, 114
 Quantizer
 effect 91
 modulation processor 111
 Questions & Answers 25

R

Ramp, channel 58
 Random
 crossfade 108
 generator 105
 modulation 108
 Realtime Controller, tutorial 117
 Receive Program Changes 21
 Reducing Bits, effect 91
 Release Velocity, modulation source 104
 Resonance
 filter 45
 Resonance, definition 114
 Retrigger 108
 Retriggering Envelopes 106
 Reverb Lite, effect 74
 Reverb, effect 73
 Reverb, envelope 72
 Reverberation, description 72
 Right Click Shortcuts 121
 Ring Modulator, effect 90

S

Sample Rate, setting 19
 SamplePool 33
 Save 33
 controller settings 31
 FX & multiseups 48
 Save As 33
 Scarlatti Tuning 54
 Scribble Strip 46
 Select on Current Channel 40

- Select Preset on Active Channel 23
- Sensitivity, MIDI controller #7 21
- Sequencing, notes cutting out 25
- Shape 128
- Show Bank & Program Numbers 100
- Show/Hide Object Numbers 100
- Small Icons 100
- Software Installation 10
- SoundFonts, playing 25
- Sources, Modulation 104
- SP12-ulator, effect 91
- Standardized MIDI Controller Numbers 124
- Summing Amps 111
- Swap FXA & FXB 69
- Swept EQ Filter 115
- Switch 111
- Sync LFO to Clock 108
- System Requirements 10

T

- Tempered Tuning 55
- Templates 56
- Tempo Control 42
 - enable/disable 21
 - via preset 53
- Tone 128
- Toolbars 97
 - viewing & hiding 98
- Transpose
 - master 42
 - preset global 52
- Tree View 100
- Tree, exploring 27
- Tremulator, effect 92
- Triggering Envelopes, from modulation sources 106
- Troubleshooting Checklist, installation 17
- Troubleshooting, common problems 25
- Tube, effect 94
- Tuning
 - keyboard 54
 - to other instruments 42
- Tuning Tables 54
- Tutorials
 - Proteus VX with Cubase LE 13
- Twin, effect 95

U

- Ultra-High Precision Interpolation 20
- Undo & Redo 101
- Update Library 34
- Use Optimal Buffer Size 19

V

- Vallotti Tuning 54
- Velocity Curve, MIDI 21
- View Menu 99

- Volume
 - in multisetup 40
 - preset global 52
- Volume Control, master 42
- Volume Curve 21
- Volume Sensitivity 21
- VST Connections, Cubase LE 13
- VST Instrument
 - Cubase LE 14
- VSTi
 - & multisetup 48
 - running 13
- VU Meter 42

W

- Waveforms, LFO 107
- Werkmeister Tuning 54
- Wet/Dry Mix, effects 67, 68
- Wheels, Pitch & Mod. 22, 104
- White Noise 108

Z

- Z-plane Filter 116

