



Programming Series

Program No.5601-SBS

110100-0

# JX PC DOS Version 2.10 User's Guide

**IBM·JX**  
*personal computer*

**First Edition (August 1985)**

Changes are periodically made to the information herein; these changes will be incorporated in new editions of the publication.

It is possible that this material may contain references to, or information about, IBM products (machines and programs), programming, or services that are not announced in your country. Such references or information must not be construed to mean that IBM intends to announce such IBM products, programming, or Services in your country.

© Copyright International Business Machines Corp. 1983, 1985

# Preface

The IBM Personal Computer JX Disk Operating System (DOS) Version 2.10 library contains the following three books:

- **DOS User's Guide**—a procedural (step-by-step) guide about how to use the more frequently used DOS commands. The DOS User's Guide helps you get started using DOS and do some simple DOS tasks. The book also contains a list of common DOS messages that you may get while using DOS.
- **DOS Reference**—a complete reference about DOS and DOS commands. The DOS Reference tells you how to use your fixed disk with DOS, and gives you information about DOS and DOS functions. A complete list of DOS messages are in this book.
- **DOS Technical Reference**—a complete reference about DOS programming considerations. The DOS Technical Reference gives you information about DOS that you may need if you are programming or developing applications. The book also describes the technical advantages and special programming characteristics of DOS.

# What Is In This Book

This book gives you step-by-step procedures that teach you how to do some everyday tasks when you use your IBM Personal Computer JX. Instruction for the following tasks are provided in this book:

- Getting a diskette ready to be used
- Copying a diskette
- Comparing your backup diskette
- Copying a file
- Comparing your backup file
- Finding out what is on a diskette
- Looking at a File
- Changing a file's name
- Removing a file from a diskette

As you become more comfortable with your computer and DOS, refer to the *DOS Reference* book for more information about these commands and the other DOS commands.

## Required Reading

You should first read the *Guide to Operations* for your computer before you use DOS.

## Considerations for Using Applications

If you use any applications with your computer, please refer to the *DOS Reference* book for information about using applications with JX DOS Version 2.10.



# Contents

<b>Chapter 1. Introduction</b> .....	1-1
<b>What Is DOS</b> .....	1-3
<b>About Your DOS Books and Diskettes</b> ....	1-4
<b>Copying Your DOS Diskettes</b> .....	1-5
<b>When You Need DOS in a Drive</b> .....	1-6
<b>What System Do You Have</b> .....	1-7
How to Use One Diskette Drive .....	1-8
How to Use Two Diskette Drives .....	1-8
<b>About Diskettes</b> .....	1-9
Format Your Diskettes .....	1-9
Write-Protect .....	1-9
<b>About Messages</b> .....	1-11
<b>Chapter 2. Files, Names, and</b>	
<b>Function Keys</b> .....	2-1
<b>Files</b> .....	2-3
How to Name Files .....	2-3
File Specifications .....	2-6
<b>Things You Do With Function Keys</b> .....	2-7
Entering a Command .....	2-8
Ending a Command .....	2-9
Correcting a Typing Mistake .....	2-10
Stopping the Screen Long Enough	
to Read It .....	2-11
Printing What Is on the Screen .....	2-12
Printing What You Type .....	2-13
Starting DOS Again .....	2-14
<b>Chapter 3. Loading DOS</b> .....	3-1
<b>Loading (Starting) DOS</b> .....	3-3
How to Insert Diskettes .....	3-3
If Your Computer Is Off .....	3-4
If Your Computer Is On .....	3-4
Date and Time .....	3-5

When DOS Is Ready .....	3-7
DOS Prompt .....	3-7
Giving DOS a Command .....	3-7
Specifying the Drive .....	3-8
<b>Chapter 4. Using DOS Commands .....</b>	<b>4-1</b>
Using DOS Commands .....	4-3
Getting a Diskette Ready to be Used .....	4-5
What's Needed? .....	4-5
FORMAT Procedure .....	4-6
Copying a Diskette .....	4-8
What's Needed? .....	4-8
DISKCOPY Procedure .....	4-9
Comparing Your Backup Diskette .....	4-12
What's Needed? .....	4-12
DISKCOMP Procedure .....	4-12
Copying a File .....	4-16
What's Needed? .....	4-16
COPY Procedure .....	4-17
Comparing Your Backup File .....	4-19
What's Needed? .....	4-19
COMP Procedure .....	4-19
Finding Out What Is on a Diskette .....	4-23
What's Needed? .....	4-23
DIR Procedure .....	4-24
Displaying What Is in a File .....	4-26
What's Needed? .....	4-26
TYPE Procedure .....	4-27
Changing a File's Name .....	4-28
What's Needed? .....	4-28
RENAME Procedure .....	4-29
Removing a File from a Diskette .....	4-30
What's Needed? .....	4-30
ERASE Procedure .....	4-31
Helps and Hints .....	4-32
<b>Appendix A. Common Messages .....</b>	<b>A-3</b>
Device Error Messages .....	A-3
Responses .....	A-7
Common Error Messages .....	A-8
<b>Index .....</b>	<b>X-1</b>



# Chapter 1. Introduction

## Contents

What Is DOS .....	1-3
About Your DOS Books and Diskettes .....	1-4
Copying Your DOS Diskettes .....	1-5
When You Need DOS in a Drive .....	1-6
What System Do You Have .....	1-7
How to Use One Diskette Drive .....	1-8
How to Use Two Diskette Drives .....	1-8
About Diskettes .....	1-9
Format Your Diskettes .....	1-9
Write-Protect .....	1-9
About Messages .....	1-11



# What Is DOS

The IBM Personal Computer JX Disk Operating System (DOS) controls the movement of information on your computer. You can think of DOS as the wild animal trainer in the circus making the animals do feats of physical skill and daring. In much the same way, DOS controls the way your computer uses programs, games, and applications.

DOS makes it easy for you to use applications and create and manage files on your computer. DOS also lets you use devices such as printers and diskette drives with your computer.

Your applications will tell you if you need to use DOS with them. If you are using DOS, this book will help you learn more about how you can use DOS to organize and maintain the information you place on your diskettes.

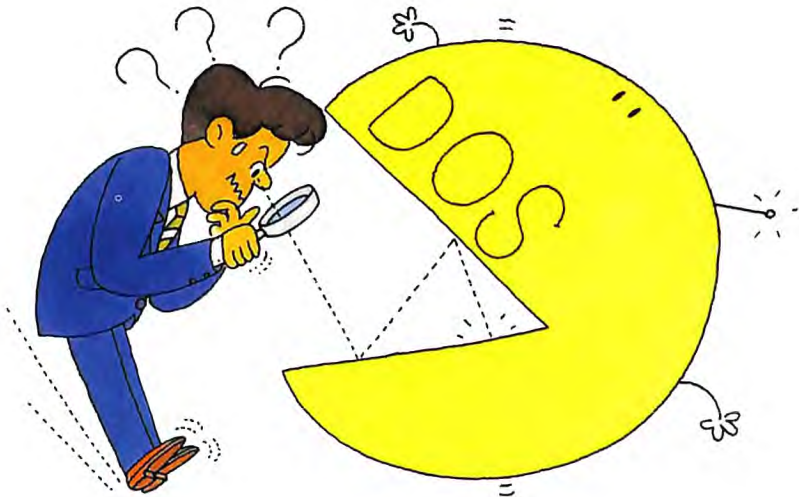

# About Your DOS Books and Diskettes

JX DOS Version 2.10 comes with three books:

- DOS User's Guide
- DOS Reference
- DOS Technical Reference

DOS also comes on one diskette. The diskette is in plastic diskette holder.

## Copying Your DOS Diskettes

Making a copy of your DOS diskette should be one of the first things you do. That way you won't be "shut down" if your DOS diskette becomes misplaced or accidentally damaged. This copy is called a *backup* and making the copy is usually called *backing up*. After you read Chapters 1, 2, and 3 refer to "Copying a Diskette" in Chapter 4 and follow the procedure to back up your DOS diskette.

When you make backup diskettes, you should label and date the backup diskette using a felt-tip pen. Use the backup diskettes in your daily operations.

## When You Need DOS in a Drive

You need to put the DOS diskette in a drive when you first *load* or start DOS. Loading DOS means that a copy of *internal* DOS commands are read from the DOS diskette and placed in the computer's memory.

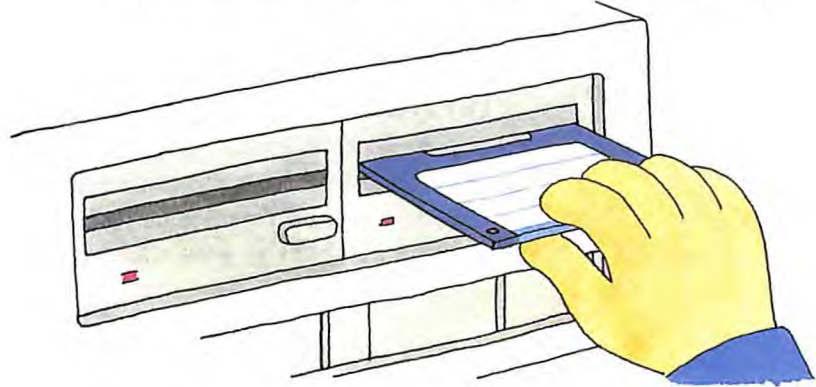

These commands are called *internal* commands because they stay in your computer's memory until you switch off your computer or until you load DOS again. Since the commands are loaded in memory, you do not need your DOS diskette in a drive to use the *internal* commands.

The rest of the commands on the DOS diskette are called *external* commands because they are not read into the computer's memory when you load DOS. Since the commands are not loaded in memory, you need your DOS diskette in a drive to use the *external* commands.

The following chart shows the internal and external commands that are covered in this book:

Internal Commands	External Commands
You won't need your DOS diskette for these commands if DOS is already loaded.	You need your DOS diskette to do these commands.
DIR COPY ERASE RENAME TYPE	FORMAT DISKCOPY COMP DISKCOMP

## What System Do You Have

Refer to your *Guide to Operations* to tell if your system unit has one, two, or three diskette drives, or if it has a fixed disk.

The examples shown in this book tell you how to use DOS with your diskette drives. You also can use DOS with a fixed disk. If you have a fixed disk, please refer to Chapter 3, "Preparing Your Fixed Disk" in the *DOS Reference* book.

## How to Use One Diskette Drive

If your computer has only one diskette drive, you should think of the one diskette drive as being *two* diskette drives (drive A and drive B). But, instead of A and B representing two physical drives, the A and B represent diskettes.

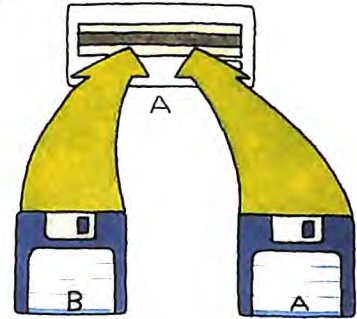

When you have one diskette drive, DOS will tell you which diskette to insert. You must make this switch each time DOS tells you to exchange diskettes.

## How to Use Two Diskette Drives

If your computer has two diskette drives, you should think of the diskette drives as drive A and drive B.

When you have two diskette drives, you can insert diskettes in drive A and in drive B. You do not have to exchange diskettes if you have two diskette drives.

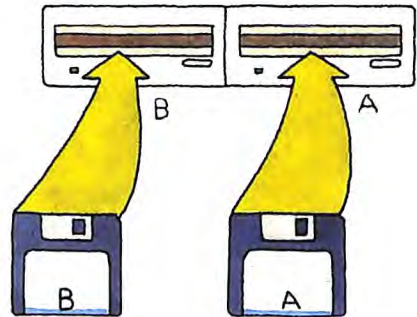



## About Diskettes

### Format Your Diskettes

You must format *every* new or blank diskette before it can be used by DOS. You do not need to use **FORMAT** every time you want to put information on a diskette—only the first time you use a diskette.

For more information about formatting diskettes, refer to “Getting a Diskette Ready to Be Used” in Chapter 4.

### Write-Protect

The JX can use both 3½" and 5¼" diskettes.

By positioning the switch as shown below, the 3½" diskette is write protected.

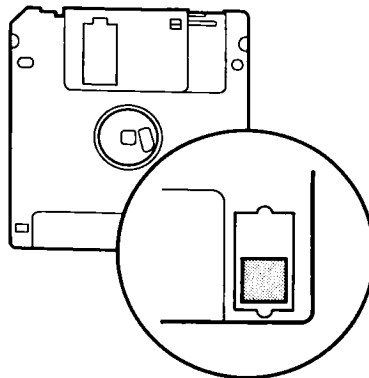

write protected

By positioning the switch as shown below, the 3½'' diskette will allow you to write or erase information on the diskette.

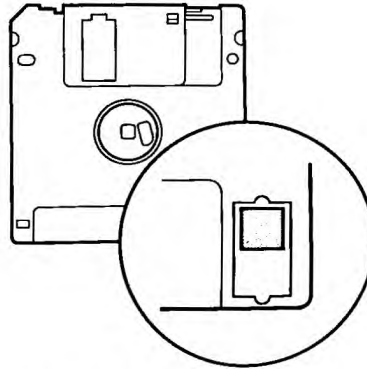

write allowed

By covering the write-protect notch on your 5¼'' diskette, you can make sure the computer cannot write over information already on the diskette.

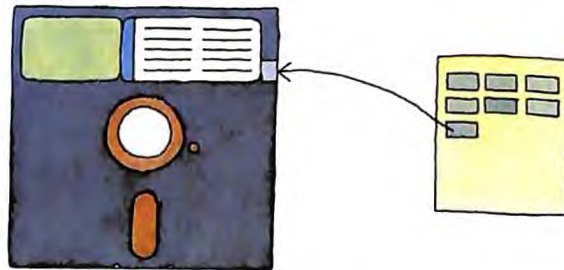

You can cover the notch with a tab supplied with the diskette, or with a piece of tape (do not use transparent tape).

When a diskette is write protected, information can only be read from the diskette. Information already on the diskette cannot accidentally be erased by being written over with new information. Important diskettes are often protected this way.

You can reposition the switch or remove the tab when you want to add or erase information on the diskette.

If your 5¼" diskette has no write-protect notch, it is already *write protected*. This means that the computer cannot store (write) any information on it.

## About Messages

You may get messages on your screen when using DOS commands. If you get a message and need help, refer to Appendix A, "Common Messages" for additional information about what *caused* the message and the *action* you should take.



# Chapter 2. Files, Names, and Function Keys

## Contents

Files .....	2-3
How to Name Files .....	2-3
Filename .....	2-5
Filename Extensions .....	2-5
File Specifications .....	2-6
Things You Do With Function Keys .....	2-7
Entering a Command .....	2-8
Ending a Command .....	2-9
Correcting a Typing Mistake .....	2-10
Stopping the Screen Long Enough to Read It .....	2-11
Printing What Is on the Screen .....	2-12
Printing What You Type .....	2-13
Starting DOS Again .....	2-14



# Files

Files consist of related information (data) you store on a diskette. Files can be stored on diskettes or on fixed disks. You can compare a file on a diskette to a file in a file cabinet. One diskette file is like a separate file folder in the file cabinet drawer, with each folder (or file) containing related information on a specific subject.

Each file has a name. When you want DOS to find a file, you give DOS the filename. Filenames are used so that DOS can find specific information easily.

## How to Name Files

You can store any combination of files on a diskette. Each file must have a unique or different name. But you can have the same name on two different diskettes.

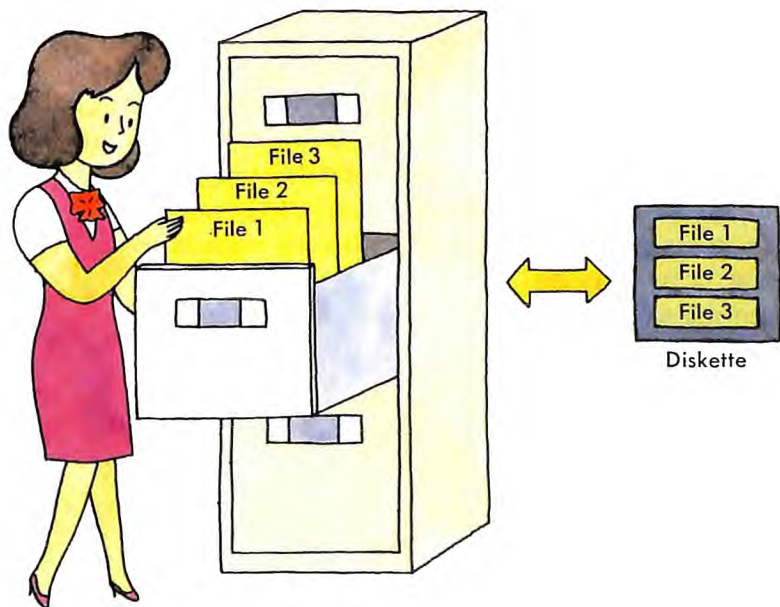

A file's name can be made up of a *filename* and an optional *extension*. For example:

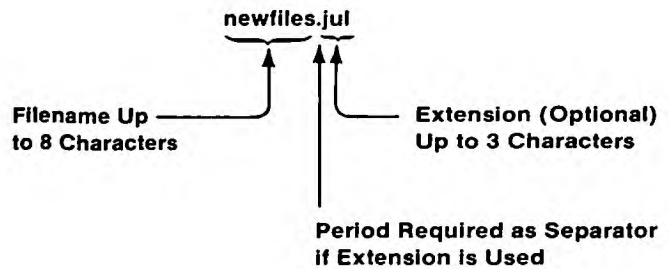

If you used the DIR command, a file named `newfiles.jul` would appear on your display screen like this:

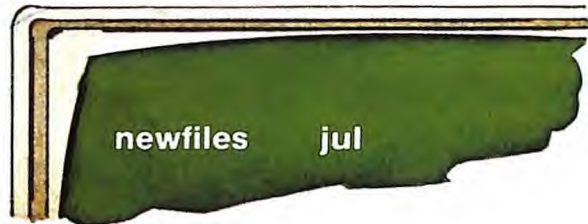

Notice that the period does not appear on the screen, but you *must* use the period when you enter a filename and extension.



## Filenames

In DOS, *filenames* are from one to eight characters long. The characters in a filename can be any of the following:

- the letters of the alphabet A – Z
- the numbers 0 through 9
- and these special characters:

\$ # & @ ! % ( ) - \_ { } ‘ ’ ~ ^

## Filename Extensions

A filename can be followed by an optional short name called an *extension*. An extension starts with a period, has one, two, or three characters, and follows immediately after the filename.

**Important:** If a filename is followed by an extension, you *must* use both parts when telling DOS about that file.

A *good* name for a file will help you remember what kind of information is in the file, and perhaps whether it's a file that contains a program or data. For example, ADDRLIST.BAS is a good name for a BASIC program file that prints an address list.

## File Specifications

The other thing that DOS needs to know to find information is where to search for a particular file. You must tell DOS the drive that contains the diskette the file is on, the name of the file, and the extension. These three parts together—the drive letter, the filename, and the extension—are called a *file specification*. For example:

A: newfiles.jul

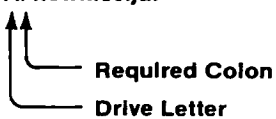

Required Colon

Drive Letter

The drive letter and the colon are called the *drive specifier*. The *drive letter* tells DOS where the file is. You always need to type the colon (:) after the drive letter as a separator.

The filename and extension immediately follow the drive letter. Do not put any spaces between the three parts.

## Things You Do With Function Keys

Your computer keyboard has some special function keys that you can use to do some tasks. Read this section now to get familiar with the function keys. Refer back to this section when you need to use the function keys to do a task.

## Entering a Command

**Function:** Enter

**Key:** Press the following key:

Enter

Use when you have finished typing a whole command.  
Remember that DOS will accept lowercase letters in all  
commands and filenames.

## Ending a Command

**Function:** Break

**Keys:** Press the following keys:

**Ctrl** plus **Break**

Use to stop a command from finishing its job normally. This is sometimes called *terminating* a program. After the DOS prompt, **A>** reappears, you can enter your next command (refer to Chapter 3, “Giving DOS a Command” for more information).

## Correcting a Typing Mistake

**Function:**      **Backspace**

**Key:**            Press the following key:



Use to correct a mistake that you notice *before* you press the  key. The easiest way is to move the cursor backward, to the leftmost wrong character. The Backspace key deletes characters as it moves the cursor to the left.

Now, type the correct characters. Press the  key when everything is the way you want it.

## Stopping the Screen Long Enough to Read It

**Function:**     **Pause Screen**

**Keys:**            **Press the following keys**

**Fn**    then    **o**



Use to pause the screen when information is appearing on the screen too fast for you to read.

When you are ready to see some more information, press any character key.

## Printing What Is on the Screen

**Function:** Print Screen

**Keys:** Press the following keys

 plus 

Use to print what is currently on the screen. First make sure the printer is on. The whole screen is printed. What is printed is often called a *hard copy* or *printout*.



## Printing What You Type

**Function:** Printer Echo

**Keys:** Press the following keys:

 plus  plus 

Use to print one line at a time as it appears on the screen. Now, each time you press the  key, or the computer displays a line, the line will be printed, or *echoed*, on the printer.

To stop echoing to the printer, press the Printer Echo keys again.

## Starting DOS Again

**Function:** System Reset

**Keys:** Press the following keys:

**Ctrl** plus **Alt** plus **Delete**

Use to restart DOS over from the beginning. You will need to put your DOS diskette into drive A. After a few seconds, you will see the DOS startup messages.

# Chapter 3. Loading DOS

## Contents

Loading (Starting) DOS .....	3-3
If Your Computer Is Off .....	3-4
If Your Computer Is On .....	3-4
Date and Time .....	3-5
Telling DOS the Date .....	3-5
Telling DOS the Time .....	3-6
When DOS Is Ready .....	3-7
DOS Prompt .....	3-7
Giving DOS a Command .....	3-7
Specifying the Drive .....	3-8



## Loading (Starting) DOS

*Starting* DOS or *loading* DOS means that a copy of the DOS internal commands are read from the DOS diskette and placed in the computer's memory.

DOS tells you it is ready when it asks you for the current date and time. After that, DOS is ready for you to enter a *command*—that is, to tell DOS what you want it to do.

## If Your Computer Is Off

- | Step | Action   |
|------|--|
| 1    | Insert the DOS diskette in drive A.  |
| 2    | Switch on the printer, if you have one, the display, and then the computer.  |
| 3    | Wait a moment while the system checks itself out. The length of the pause depends on the amount of memory in your computer; the more memory, the longer the pause. |

## If Your Computer Is On

- | Step | Action  |
|------|---|
| 1    | Insert the DOS diskette in drive A.   |
| 2    | Press and hold the System Reset keys:<br><br><b>Ctrl</b> plus <b>Alt</b> plus <b>Delete</b><br><br>then release them all. |
| 3    | You will see the diskette drive light come on while DOS is being read, and you may hear some clicks and whirs.            |

**Remember:** Always insert the diskette with the label side up.

## Date and Time

### Telling DOS the Date

When DOS is loaded and ready, you will see a message similar to this on the screen:



```
Current date is Tue 1-01-1980
Enter new date:
```

The cursor shows where the first number you type will appear.

For example, suppose the current date is August 5, 1982. You can enter:

```
8-5-82 or
8/5/82
```

You use the number keys to set the date:

- | Step | Action   |
|------|--|
| 1    | Enter one or two numbers between 1 and 12 for the month.   |
| 2    | Enter a dash (-) or a slash (/).   |
| 3    | Enter one or two numbers between 1 and 31 for the day.   |
| 4    | Enter another dash (-) or slash (/).   |
| 5    | Enter the last two numbers of the year between 80 and 99.  |
| 6    | Press the  key. |

## Telling DOS the Time

After you have entered the date, DOS displays a message similar to this:

```
Current time is 0:01:05.58
Enter new time: __
```



The time displayed is:

HOURS:MINUTES:SECONDS.HUNDREDTHS OF SECONDS

You use the number keys to set the time:

- | Step | Action  |
|------|---|
| 1    | Enter one or two numbers between 0 and 23 for the hours.  |
| 2    | Enter a colon (:).  |
|      | <b>Note:</b> A dash (-) or a slash (/) does not work.   |
| 3    | Enter one or two numbers between 0 and 59 for the minutes. If you wish to enter the seconds and hundredths of a second, refer to the TIME command in the <i>DOS Reference</i> book, but if the hours and minutes are sufficient, proceed to the next step. DOS will set the remaining values to zero for you. |
| 4    | Now press the  key.  |



## When DOS Is Ready

After you have entered the date and time, DOS displays this:

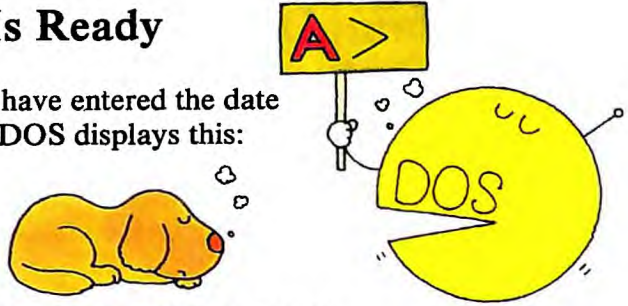

The IBM Personal Computer DOS  
Version 2.10 (C)Copyright IBM Corp 1981, 1982, 1983  
A>\_

## DOS Prompt

The A> is the DOS *prompt*. It tells you that DOS is ready and it is your turn to enter information; that is, to tell DOS what to do by entering a command.

## Giving DOS a Command

To give DOS a command:

- | Step | Action   |
|------|--|
| 1    | Wait until you see the DOS prompt, A>.   |
| 2    | Enter the command and any other parts the command requires (for example, a drive specifier or a file specification). Refer to “How To Name Files” and “File Specifications” in Chapter 2 for more information. |

You can enter commands in uppercase or lowercase letters (or a combination). For example:

**COPY a:file01 b:file02**

Use a blank (press the Spacebar) to separate the parts of the command from each other.

**3** Press the  key when you have finished.

**Remember:** The DOS command must be the first thing on the input line.

## Specifying the Default Drive

The **A** in the prompt designates the *default drive*. DOS searches the disk in the default drive to find any commands or filenames that you enter, unless you specify another drive in the file specification. You can change the default drive in the prompt by entering the new drive designation letter followed by a colon. For example:

```
A> (original prompt)
A>B: (new drive designation)
B> (new prompt)
```

Now, **B** is the drive DOS searches to find any commands or filenames that you enter, unless you specify a drive in the file specification.

**Remember,** if you do not specify a drive when you enter a command or filename, the system automatically searches the disk located in the default drive. The default drive may be different from the last disk used in a single-drive system. For example, if the last command was `DIR B:`, DOS believes the drive B diskette is still in the drive; but the system prompt is still `A>` (because drive A is the default drive).

# Chapter 4. Using DOS Commands

## Contents

Using DOS Commands .....	4-3
Getting a Diskette Ready to be Used .....	4-5
What's Needed? .....	4-5
FORMAT Procedure .....	4-6
Copying a Diskette .....	4-8
What's Needed? .....	4-8
DISKCOPY Procedure .....	4-9
Comparing Your Backup Diskette .....	4-12
What's Needed? .....	4-12
DISKCOMP Procedure .....	4-12
Copying a File .....	4-16
What's Needed? .....	4-16
COPY Procedure .....	4-17
Comparing Your Backup File .....	4-19
What's Needed? .....	4-19
COMP Procedure .....	4-19
Finding Out What Is on a Diskette .....	4-23
What's Needed? .....	4-23
DIR Procedure .....	4-24
Displaying What Is in a File .....	4-26
What's Needed? .....	4-26
TYPE Procedure .....	4-27
Changing a File's Name .....	4-28
What's Needed? .....	4-28
RENAME Procedure .....	4-29
Removing a File from a Diskette .....	4-30
What's Needed? .....	4-30
ERASE Procedure .....	4-31
Helps and Hints .....	4-32



# Using DOS Commands

Now, let's take a look at how to use the more frequently used DOS commands for the tasks you may need to do from time to time.

You can use these DOS commands to do the following tasks:

- Getting a diskette ready to be used (FORMAT)
- Copying a diskette (DISKCOPY)
- Comparing your backup diskette (DISKCOMP)
- Copying a file (COPY)
- Comparing your backup file (COMP)
- Finding out what files are on a diskette (DIR)
- Looking at a file (TYPE)
- Changing a file's name (RENAME)
- Removing a file from a diskette (ERASE)

Read this chapter now to get familiar with these commands. Refer to them when you need to do a task.

As you become more comfortable with your computer and DOS, refer to the *DOS Reference* book for more information about these commands and the other DOS commands.

If you get a message on your screen and you need help, refer to Appendix A, “Common Messages” for more information.

**Remember:** After loading DOS, you do not need your DOS diskette in a drive to use the internal commands. You need the DOS diskette in a drive to use external commands. Refer to Chapter 2, “DOS Commands” in the *DOS Reference* book for a complete list of internal and external commands.

## Getting a Diskette Ready to be Used

Use the `FORMAT` command to get a diskette ready to receive information. `FORMAT` checks the diskette for bad spots, and builds a directory to hold information about the files that will eventually be written on it.

You only need to use `FORMAT` once per diskette, when it is new.

### What's Needed?

You need your DOS diskette and the diskette you want to format.

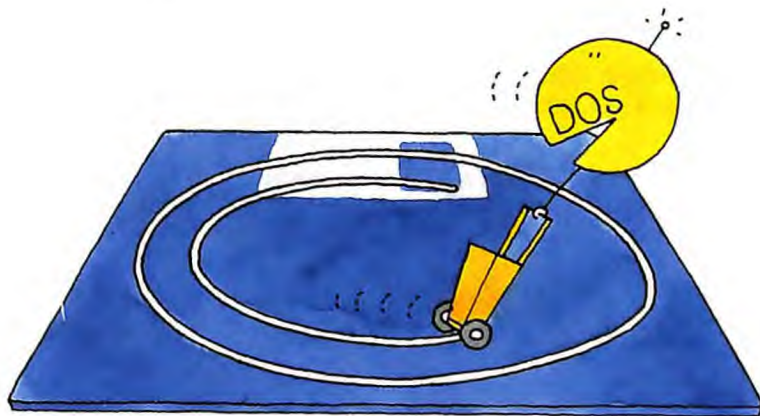

## FORMAT Procedure

If you have one drive, DOS will treat it as both drive A and drive B. You must switch diskettes each time DOS tells you to exchange diskettes until you see the message that appears in step 5.

- | Step | Action   |
|------|--|
| 1    | Make sure DOS is ready and A> is displayed.                      |
| 2    | Insert your DOS diskette in drive A, if it is not already there. |
| 3    | Enter this:  |

**format b:**

This message appears:

**Insert new diskette for drive B:  
and strike any key when ready**

**Note:** If you have two drives, insert your new diskette in drive B, if it is not already there. You will *not* have to remove the DOS diskette.

Now press the  key and go to step 5.



- | <b>Step</b> | <b>Action</b>   |
|-------------|---|
| <b>4</b>    | <p>If you have one drive</p> <ul style="list-style-type: none"><li>● When the drive A “in use” light is off, remove the DOS diskette from drive A.</li><li>● Insert your new diskette in the drive.</li><li>● Press any key—the Spacebar for instance.</li></ul>  |
| <b>5</b>    | <p>You will see a <b>Formatting. . .</b> message. After a few seconds, you will see:</p> <p style="padding-left: 40px;"><b>Formatting. . .Format complete</b></p> <p style="padding-left: 80px;"><b>xxxxxx bytes total disk space</b><br/><b>xxxxxx bytes available on disk</b></p> <p style="padding-left: 40px;"><b>Format another (Y/N)?</b></p> |
| <b>6</b>    | <p>Enter: <b>n</b></p> <p>If you have more diskettes to format, enter <b>y</b>.</p> <p>You do not have to press the Enter key. Now you will see the DOS prompt, <b>A&gt;</b>, and you can remove your newly formatted diskette. The diskette is now ready to be used.</p>   |

## Copying a Diskette

Use the `DISKCOPY` command to make a backup copy of an entire diskette on another diskette. (Copying one file is discussed in “Copying a File” in this chapter.)



It is a good habit to back up your *program* diskettes as soon as you purchase or create them. Then use the backup diskettes for everyday operations.

### What's Needed?

You will need:

- Your **DOS** diskette.
- The original diskette you want to back up—we're going to call this your **source** diskette.
- The diskette that will become the backup diskette—we're going to call this the **target** diskette.

## DISKCOPY Procedure

If you have one drive, DOS will treat it as both drive A and drive B. You must switch diskettes each time DOS tells you to exchange diskettes until you see the message that appears in step 6.

**Hint:** For this procedure, you can remember which diskette to insert, if you remember “Source=Original” and “target=backup.”

- | Step | Action   |
|------|--|
| 1    | Make sure DOS is ready and A> is displayed.  |
| 2    | Insert the DOS diskette in drive A, if it is not already there.  |
| 3    | Enter this:<br><br><b>diskcopy a: b:</b><br><br>and press the  key.              |
| 4    | If you have two drives—this message appears:<br><br><b>Insert source diskette in drive A:<br/>Insert target diskette in drive B:<br/>Strike any key when ready</b> |

*Now* remove the DOS diskette.

If you have two drives, insert the source diskette in drive A and the target diskette in drive B, if you have not already done so. You will *not* have to switch diskettes. You will see the message that appears in step 6.

**Step      Action**

**If you have one drive—this message appears:**

**Insert source diskette in drive A:  
Strike any key when ready**

- Remove your DOS diskette that is in drive A, if you have not already done so. (If you are copying your DOS diskette, leave it in the drive.)
- Insert your source diskette in drive A.
- *Now* press any key.

**Note:** Depending on the amount of memory in your computer, you may have to switch the diskettes until you see the message that appears in step **6**.

**5** The “in use” light comes on while the source diskette is being read, and then this is displayed:

**Insert target diskette in drive A:  
Strike any key when ready**

- Remove your source diskette.
- Insert the target (backup) diskette.
- *Now* press any key.

**Step      Action**

**6**      The “in use” light comes on while the backup diskette is being written. Then the message shown in step **4** appears again. Keep repeating steps **4** and **5** until this message appears:

**Copy complete**

**Copy another (Y/N)?**

**7**      Enter: **n**

If you have more diskettes to copy, enter **y**.

You don't have to press the Enter key. The DOS prompt, **A>**, is displayed. Remove the backup diskette from the drive. With a felt-tip pen, mark the label with the contents, the date, and perhaps the word “Backup.”

**Note:** You may get the message:

**Insert COMMAND.COM disk in drive A:  
and strike any key when ready**

before the DOS prompt, **A>**, is displayed.

If you get this message, insert the DOS diskette in drive A and press any key. then the DOS prompt, **A>**, will be displayed.

## Comparing Your Backup Diskette

The next step is to make sure the backup diskette that you just made using DISKCOPY was copied correctly.

### What's Needed?

You need the diskettes that you used in the DISKCOPY procedure.

### DISKCOMP Procedure

If you have one drive, DOS will treat it as both drive A and B. You must switch diskettes each time DOS tells you to exchange diskettes until you see the message that appears in step 6.

**Hint:** For this procedure, the source diskette is the *first* diskette and the target diskette is the *second* diskette.

- | Step | Action   |
|------|--|
| 1    | Make sure DOS is ready, and A> is displayed.   |
| 2    | Insert the DOS diskette in drive A, if it is not already there.  |
| 3    | Enter this:<br><br><b>diskcomp a: b:</b><br><br>and press the  key. |

**Step Action**

**4** If you have two drives—this message appears:

**Insert first diskette in drive A:  
Insert second diskette in drive B:  
Strike any key when ready**

**Note:** If you have two drives, insert the first diskette in drive A and the second diskette in drive B, if you have not already done so. You will *not* have to switch diskettes. You will see the message that appears in step **6**.

If you have one drive—this message appears:

**Insert first diskette in drive A:  
Strike any key when ready**

- Remove the DOS diskette from drive A.
- Insert the source (original) diskette into drive A.
- *Now* press any key.

**Note:** Depending on the amount of memory in your computer, you may have to switch the diskettes until you see the message that appears in step **6**.

<b>Step</b>	<b>Action</b>
<b>5</b>	The “in use” light comes on while the source diskette is being read, and then this message is displayed:

**Insert second diskette in drive A:  
Strike any key when ready**

- Remove the source diskette from drive A.
- Insert the target (backup) diskette into drive A.
- *Now* press any key.

<b>6</b>	You will see the “in use” light come on while the backup diskette is being compared. Then the message shown in step <b>4</b> appears again. Keep repeating steps <b>4</b> and <b>5</b> until this message appears:
----------	--

**Diskettes compare ok**

**Compare more diskettes (Y/N)?**



**Step      Action**

**7            Enter: n**

You do not have to press the Enter key. The DOS prompt, A>, is displayed. Now you can put both diskettes away—your backup file is good.

**Note:** You may get the message:

**Insert COMMAND.COM disk in drive x:  
and strike any key when ready**

before the DOS prompt, A>, is displayed.

If you get this message, insert the DOS diskette in drive A and press any key. Then the DOS prompt, A>, will be displayed.

If the diskettes are not identical, go through the copying and comparing steps again.

## Copying a File

Use the **COPY** command when you want to copy one file instead of a whole diskette.

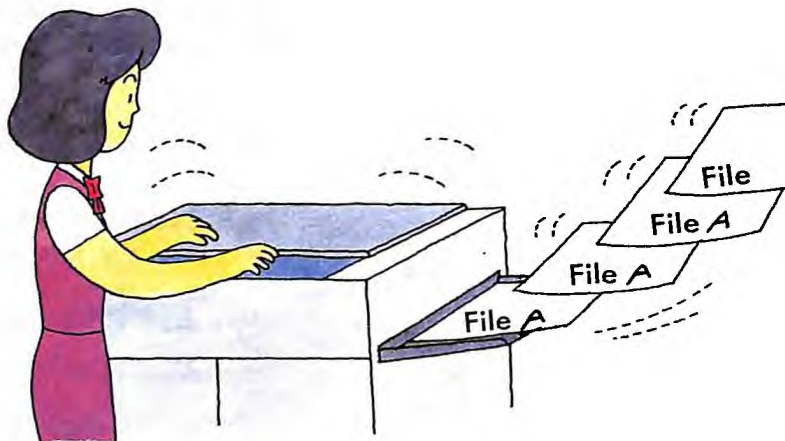

### What's Needed?

You will need:

- The diskette that contains the file you want to copy. We'll call this the **source** diskette.
- The diskette that will contain the copy of the file when you are done. We'll call this the **target**.

If DOS has already been loaded, you do not need your DOS diskette for this procedure. Also decide on the new name for the copied file on the target diskette.

## COPY Procedure

If you have one drive, DOS will treat it as both drive A and drive B. You must switch diskettes each time DOS tells you to exchange diskettes until you see the message that appears in step 5.

**Hint:** It's easier to remember which diskette to insert if you think "B is for backup." Insert the backup diskette when the drive B message appears.

- | Step | Action  |
|------|---|
| 1    | Make sure DOS is ready and A> is displayed.                               |
| 2    | Insert the diskette with the file on it (the source diskette) in drive A. |
| 3    | Enter the file's name like this:  |

**copy filename b:**

Enter the name of your file for *filename*. Notice again where the spaces are.

**Note:** If you have two drives, insert the source diskette in drive A and the target diskette in drive B. You will *not* have to switch diskettes. You will see the message that appears in step 5.

Now press the  key.

**Step**      **Action**

**4**            If you have one drive—this message appears:

**Insert diskette for drive B: and strike  
any key when ready**

- Remove the source diskette. (But don't put it away—you may need it soon.)
- Insert the previously formatted target (backup) diskette in drive A.
- *Now* press any key.

**Note:** Depending on the size of the file being copied and your computer's memory, you may need to switch the diskettes until you see the message that appears in step 5.

**5**            When the copy has been made, this message is displayed:

**1 File(s) copied**

**A>\_**

Remove the backup diskette from the drive and label it with a felt-tip pen. Now you can put both diskettes away—your file has been copied to the second diskette.

## Comparing Your Backup File

The next step is to make sure the file that you just copied to the backup diskette using COPY is identical to the source (original) diskette.

### What's Needed?

You need the diskettes that you used in the COPY procedure.

### COMP Procedure

If you have one drive, DOS will treat it as both drive A and drive B. You must switch diskettes each time DOS tells you to exchange diskettes until you see the message that appears in step 6.

Step	Action
1	Make sure DOS is ready and A> is displayed.
2	Insert the DOS diskette in drive A.

**Step Action**

**3** Enter this:

**comp**

and press the **Enter** key.

**Note:** If you get the message:

**Insert diskette for drive A: and  
strike any key when ready**

leave the DOS diskette in the drive and  
press any key (see step **4**).

**4** DOS will prompt you for the *primary* file  
(the file on the source diskette). This message  
appears:

**Enter primary file name**

- Remove your DOS diskette from  
drive A.
- Insert your source diskette  
in drive A.

when you see this message, enter:

**a:filename**

Enter the file's name from the source diskette  
for *filename*.

Now press the **Enter** key. Then this message  
appears:

**Enter 2nd file name or drive id**

**Step Action**

When you see this message, enter:

**b:filename**

Enter the name of the file you copied to the backup diskette.

**Note:** If you have two drives, insert the source diskette in drive A and the target diskette in drive B, if you have not already done so. You will *not* have to switch diskettes. You will see the message that appears in step 6.

Now press the **Enter** key. The names of the files being compared are displayed.

**5**

If you have one drive—this message appears:

**Insert diskette for drive B: and strike any key when ready**

- Remove your source diskette from drive A.
- Insert your target (backup) diskette in drive A.
- Now press any key.

**Note:** Depending on the size of the files being compared and your computer's memory, you may have to switch the diskettes until you see the message that appears in step 6.

**Step      Action**

**6**      When files have been compared, and the files are identical, this message appears:

**Files compare ok**

**Compare more files (Y/N)?**

**7**      Enter: **n**

You do not have to press the Enter key. The DOS prompt, **A>**, is displayed. Now you can put both diskettes away—your backup file is good.

**Note:** You may get the message:

**insert COMMAND.COM disk in drive x:  
and strike any key when ready**

before the DOS prompt, **A>**, is displayed.

If you get this message, insert the DOS diskette in drive **A** and press any key. Then the DOS prompt, **A>**, will be displayed.

If the files are not identical, go through the copying and comparing steps again.



## Finding Out What Is on a Diskette

Use the DIR command to find out what files are on a diskette—perhaps because you need to find out how a particular filename is spelled, or because you can not recall what's on a seldom-used diskette.



### What's Needed?

You will need:

- The diskette whose file directory you want to see.

If DOS has already been loaded, you do not need your DOS diskette for this procedure.

## DIR Procedure

- | Step | Action  |
|------|---|
| 1    | Make sure DOS is ready and A> is displayed.   |
| 2    | Insert in drive A the diskette that has the directory you want to list.   |
| 3    | Enter this:<br><br><b>dir</b><br><br>and press the <input type="button" value="Enter"/> key.  |
| 4    | Watch the screen. The first message to appear displays the volume label of the diskette (if it has one), followed by the name of the directory that is being listed. Then the files in that directory are listed.<br><br>The screen displays the <i>filename</i> , the <i>extension</i> , the <i>size</i> of the file (in bytes), the date and the time that information was last written in the file. One line is displayed for each file on the diskette.<br><br>After the files have been listed, DIR displays the amount of free space left on the diskette (in bytes). |

**Step      Action**

- 5**            When all the files have been displayed, the DOS prompt, A>, appears.

**Remember:** If the screen is moving too fast for you to read, you can use the following Pause Screen keys to stop the screen:

**Fn** then **a**

You can also use the following Printer Echo keys to print what appears on the screen:

**Ctrl** plus **shif** plus **PrtSc**

To stop echoing to the printer, press the keys again. Refer to Chapter 2 “Things You Do With Function Keys” for more information.

## Displaying What Is in a File

The `TYPE` command lets you “look into” a file; that is, it displays the contents of a file on the screen.

Text files are displayed in a legible format. Non-text files, such as object program files, may not be readable because of the presence of characters that are not alphabetic or not numeric.

### What's Needed?

You will need:



- The diskette that has the file you want to display.
- You also need to know the exact name of the file (use `DIR` again).

If DOS has already been loaded, you do not need your DOS diskette for this procedure.

## TYPE Procedure

- | Step | Action   |
|------|--|
| 1    | Make sure DOS is ready for a command; A> is displayed.   |
| 2    | Insert the diskette in drive A.  |
| 3    | Enter this:<br><br><b>type filename</b><br><br>Enter the name of your file for <i>filename</i> .<br><br>Now press the  key. |
| 4    | The command you just entered and contents of the file will be displayed.   |
| 5    | When you see the DOS prompt, A>, you can remove the diskette and put it away.  |

**Remember:** If information is appearing on the screen too fast for you to read use the following Pause Screen keys:

 then 

When you are ready to see some more information, press any character key.

## Changing a File's Name

The `RENAME` command lets you change a file's name— either its filename, its extension, or both.

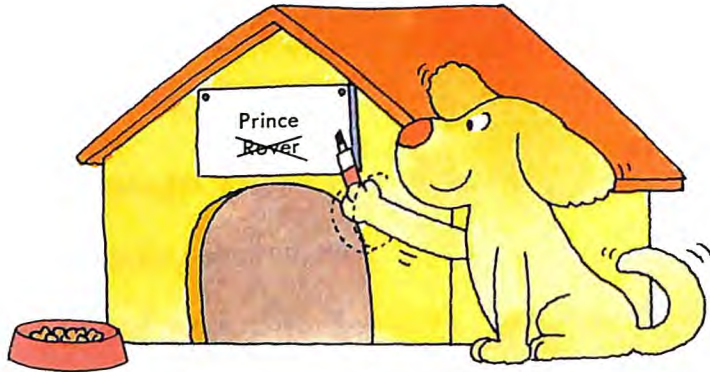

The `RENAME` command may be useful if you've found that you simply cannot type a name the way you've spelled it. More often, the reason for changing is that you just want to refer to a file with a different name.

### What's Needed?

You will need:

- The diskette with the file that you want to rename.
- You also need to know its exact "current" filename and extension, if it has one. (Remember, you can use the `DIR` command to find out the filename and extension.)

If DOS has already been loaded, you do not need your DOS diskette for this procedure.

## RENAME Procedure

Step	Action
------	--------

1	Make sure DOS is ready and A> is displayed.
---	---

2	Insert the diskette in drive A, if it is not already there.
---	---

3	Enter this:
---	-------------

**rename *old-filename new-filename***

Enter the name of your old and new file for *filename*. Check your typing.

Now press the  key.

Notice that the “current” name is first, then a space, and then the “new” name.

4	In a moment, DOS displays the prompt, A>, and the file has been renamed.
---	--

## Removing a File from a Diskette

Use the ERASE command to remove files that you no longer need from diskettes.

Removing old files makes room for new information on a diskette. It can eliminate a potential source of confusion too—you are less likely to use an old version of a program or an old data file for processing.

**Important:** *plan ahead and check your typing* when you use ERASE. Because once a file's been erased, you cannot get it back.



### What's Needed?

You will need:

- The diskette with the file that you want to erase.
- You also need to know the exact filename and extension of that file (use DIR if you need to).

If DOS has already been loaded, you do not need your DOS diskette for this procedure.



## ERASE Procedure

- | Step | Action   |
|------|--|
| 1    | Make sure DOS is ready with A> displayed.  |
| 2    | Insert the diskette with the file you no longer need in drive A, if it is not already there.   |
| 3    | Enter this:<br><br><b>erase filename</b><br><br>Enter the name of your file for <i>filename</i> .<br>Then check your typing.<br><br>Now press the  key. |
| 4    | In a moment, DOS shows you the prompt, A>. The file has been removed from the diskette.  |

## Helps and Hints

We are ending this chapter with a few hints—maybe they will save you some trouble or help you as you use your IBM Personal Computer JX.

- Make backup copies of your diskettes regularly.
- Sometimes, commands do not work as you expected.
  - Check your typing.
  - Do you have the correct diskette in the drive?
  - Check the directory of the diskette with the DIR command.
  - Has the correct diskette drive been specified or is it being assumed? Has the colon been included?
  - Has the filename been spelled correctly?
  - Have you forgotten to use the extension? (In the case of BASIC program files, for example, it is easy to forget the .BAS that BASIC uses for an extension.)
- If a command still doesn't work, refer to the *DOS Reference* book for additional information.
- Print a directory frequently (if you have a printer) and store the listing with the diskette. Refer to "Printing What Is on the Screen" in Chapter 2 for instructions.
- All commands (except DISKCOPY and DISKCOMP) that use files will work on both diskettes and fixed disks.

- The date and time shown with each directory entry are the date and time of the last addition or change to that file. The date and time are not changed during a COPY or a DISKCOPY.

At first glance, copying all files on a diskette may appear to have the same purpose as DISKCOPY. It does, but only when copying to a diskette with no files on it.

With COPY, if files already exist on the backup diskette, they will either be replaced (if files being copied have the same name) or left alone. This is because COPY goes through the original diskette, copying each file, one at a time. COPY does not disturb old files on the backup diskette as long as their names aren't the same as files being copied.

DISKCOPY, however, makes a “carbon copy” of the original diskette, wiping out all old files on the backup diskette during the COPY process.



# Appendixes

## Contents

<b>Appendix A. Common Messages</b> .....	<b>A-3</b>
<b>Device Error Messages</b> .....	<b>A-3</b>
<b>Responses</b> .....	<b>A-7</b>
<b>Common Error Messages</b> .....	<b>A-8</b>
<b>Index</b> .....	<b>X-1</b>



# Appendix A. Common Messages

This appendix contains two parts; first, *device errors* (the message that DOS uses to indicate errors while reading or writing to devices on your computer), and second, *common error messages* in alphabetic order. Each message is indicated here in **bold type**, and the description follows the message.

The first word of the description of each message is the name of the program or command that generated the message.

## Device Error Messages

When an error is detected while reading or writing any of the devices (such as disk drives and printer) on your system, DOS displays a message in the following format:

**<type> error reading <device>  
Abort, Retry, Ignore?**

or

**<type> error writing <device>  
Abort, Retry, Ignore?**

In these messages, *<device>* is the name of the device in error, such as **PRN**, or **B:**, and *<type>* is one of the following error types:

### **Data**

**Cause:** The computer (or DOS) was not able to read or write the data correctly.

**Action:** Refer to “Responses” in this Appendix. Try to correct the error by choosing **Retry** several times. Choose **Abort** if you want to end the program. This message usually means a diskette has developed a defective spot.

### **Disk**

**Cause:** An error of a type not described elsewhere in this list has occurred.

**Action:** Refer to “Responses” in this Appendix. Choose **Retry** or **Abort**. This problem requires further investigation by a programmer.

If this is a purchased program, contact the dealer you purchased it from.

### **No paper**

**Cause:** The indicated printer is either out of paper or is not switched on.

**Action:** Refer to “Responses” in this Appendix. Switch on the printer, press the **ONLINE** switch, or add paper and retry.



## Non-DOS disk

**Cause:** The file allocation table contains invalid *information*.

**Action:** Refer to “Responses” in this Appendix. The diskette needs to be reformatted.

**Note:** Try running CHKDSK to see if any corrective action is possible. Reformatting will correct the disk, but the files are lost forever. For more information about CHKDSK refer to the *DOS Reference* book.

## Not ready

**Cause:** The named device is not ready, and cannot accept or transmit data.

**Action:** Refer to “Responses” in this Appendix. Check that the disk drive door is closed and choose **Retry** for your response if this is the problem.

## Read fault

**Cause:** DOS was unable to successfully read the data from the device.

**Action:** Refer to “Responses” in this Appendix. Make sure the diskette has been properly inserted in the drive. Then choose **Retry**.

## Sector not found

**Cause:** The sector containing the data could not be located on the diskette.

**Action:** Refer to “Responses” in this Appendix. This problem usually occurs when a defective spot develops on the diskette. The diskette needs to be reformatted (copy all files from it first).

## **Seek**

**Cause:** The diskette drive was unable to locate the proper track on the disk.

**Action:** Refer to “Responses” in this Appendix. Make sure the diskette has been properly inserted in the drive. Try a different drive.

## **Write fault**

**Cause:** DOS was unable to successfully write the data to the device.

**Action:** Refer to “Responses” in this Appendix. Make sure the diskette has been properly inserted in the drive. If that is not the problem, choose Retry. If you get the same message, choose Abort and retry the command with a new diskette.

## **Write protect**

**Cause:** An attempt was made to write on a write-protected diskette.

**Action:** Investigate carefully whether you want to write on a write-protected diskette.

**Warning:** If any of these messages appear for a diskette drive, **DO NOT** change diskettes before responding with A, R, or I.

## Responses

The computer now waits for you to respond. If you know what caused the problem, you can take corrective action before you actually choose a response. The computer waits until *one* of the following responses is made. Enter:

- **A** for Abort. The system ends the program that requested the disk read or write.
- **R** for Retry. The system tries the disk read or write operation again.
- **I** for Ignore. The system pretends the error did not occur and continues the program.

To recover from an error condition, the responses are generally made in the following order:

1. **R** to retry the operation because the error may not occur again.
2. **A** to abort the program.
3. **I** to ignore the error condition and continue the program.

**Note:** This response is not recommended because data is lost when you use it.

## Common Error Messages

This section contains an alphabetic list of some of the more common DOS messages you may get on your screen. (The remainder of the DOS messages are in the *DOS Reference* book). Each message is indicated here by bold type, and the description follows the message.

### **Attempted write-protect violation**

**Cause:** **FORMAT**. The diskette being formatted cannot be written on because it is write-protected.

**Action:** You are prompted to insert a new diskette and press any key to restart formatting.

### **Bad command or filename**

**Cause:** **DOS**. The command just entered is not a valid command to DOS.

**Action:** You should check your spelling and reenter the command. If the command name is correct, check to see that the default drive contains the external command or batch file you are trying to run.

### **Compare error(s) on track xx, side xx**

**Cause:** **DISKCOMP**. One or more locations on the indicated track and side contain differing information between the diskettes being compared

**Action:** This message informs you that there is a difference between diskettes. If you want an exact copy of a diskette, use **DISKCOPY**.

### **Duplicate filename or file not found**

**Cause:** **RENAME.** You tried to rename a file to a filename that already exists on the diskette, or the file to be renamed could not be found on the specified (or default) drive.

**Action:** **RENAME** is warning you that you are using the same name for two files, or else it cannot find the file you are trying to rename. Did you type the filename and drive correctly? Take a second look at the filename you want to change, and reenter the command.

### **File cannot be copied onto itself**

**Cause:** **DOS.** A request is made to **COPY** a file and place the copy (with the same name) on the same diskette drive and the same diskette as the original.

**Action:** Change the destination name given to the copy, or put it in a different diskette drive, or put it on another diskette.

### **File creation error**

**Cause:** **DOS** and commands. An unsuccessful attempt was made to add a new filename to the directory or to replace a file that was already there.

**Action:** If the file was already there, check whether the file is marked “read only” and cannot be replaced. Otherwise, run **CHKDSK** to determine if the directory is full or if some other condition caused the error.

### **File not found**

**Cause:** DOS and commands. A file named in a command or command parameter does not exist on the diskette in the specified (or default) drive.

**Action:** Retry the command using the correct filename.

### **Format failure**

**Cause:** FORMAT. A disk error was encountered while creating the target diskette.

**Action:** The diskette is unusable. Retry the command using another diskette.

### **Insert COMMAND.COM disk in drive x: and strike any key when ready**

**Cause:** DOS. DOS is attempting to reload the command processor, but COMMAND.COM is not in the drive that DOS was started from.

**Action:** Insert the DOS diskette in the indicated drive and press any key.

### **Invalid COMMAND.COM in drive x**

**Cause:** DOS. While trying to reload the command processor, the copy of COMMAND.COM on the diskette was found to be an incorrect version.

**Action:** You need to insert the correct DOS diskette in drive x.

### **Invalid number of parameters**

**Cause:** Commands. You have specified too few or too many parameters for the command you entered.

**Action:** Correct the command you entered and try again.

### **Non-System disk or disk error Replace and strike any key when ready**

**Cause:** Startup. There is no entry for **IBMBIO.COM** or **IBMDOS.COM** in the directory; or a disk read error occurred while starting up the system.

**Action:** Insert a DOS diskette in drive **A** and restart your system.

### **Target diskette may be unusable**

**Cause:** **DISKCOPY**. This message follows an unrecoverable read, write, or verify error message. The copy on the target diskette may be incomplete because of the unrecoverable I/O error.

**Action:** If the error is on the target diskette get a new target diskette. If the error is on the source diskette, copy all the files from it to another diskette. Then reformat the source diskette.

### **Track 0 bad – disk unusable**

**Cause:** **FORMAT**. Track 0 is where the boot record, file allocation table, and directory must reside. The diskette is unusable.

**Action:** Try again with another diskette and retry the **FORMAT** command.





# Index

## A

abort read/write  
operation A-7  
about messages 1-11

## B

backing-up one file 4-16  
Backspace function key 2-10  
backup diskette  
compare 4-12  
books, about DOS 1-4  
Break function key 2-9

## C

change a filename 4-28  
change drive letter 3-8  
commands, how to use 4-3  
commands, internal and  
external 1-6  
common messages A-3  
COMP command 4-19  
COMP procedure 4-19  
compare your original to the  
copy 4-19  
comparing your backup  
copy 4-12  
comparing your backup  
file 4-19  
control keys 2-7  
copy a file to another  
diskette 4-17

COPY procedure 4-17  
copying a diskette 4-8  
copying a file 4-16  
copying DOS 1-5  
copying your DOS  
diskettes 1-5  
correcting a typing  
mistake 2-10

## D

delete a file 4-30  
device error messages A-3  
DIR command 4-23  
DIR procedure 4-24  
DISKCOMP procedure 4-12  
DISKCOPY command,  
copying a diskette 4-8  
DISKCOPY procedure 4-9  
diskette drives, how to  
use 1-7  
diskette write-protect  
notch 1-10  
diskette, copy a file to  
another 4-17  
diskette, finding what's  
on a 4-23  
diskette, formatting 4-6  
diskette, getting ready 4-5  
diskette, how to compare  
backup 4-12  
diskette, remove a file 4-30  
diskettes, copying DOS 1-5  
diskettes, how to insert 3-3  
display what's in a file 4-26

- DOS books 1-4
- DOS diskette, about your 1-4
- DOS function keys 2-7
- DOS prompt 3-7
- DOS, copying your diskettes 1-5
- DOS, giving a command 3-7
- DOS, how to use the commands 4-3
- DOS, start over 2-14
- DOS, starting 3-3
- DOS, system reset 3-4
- DOS, when you need in a drive 1-6
- drive letter, what is 2-6
- drive specifier 2-6
- drive, change letter 3-8
- drive, specifying the 3-8

## E

- ending a command 2-9
- Enter key function 2-8
- entering a command 2-8
- erase a file 4-30
- ERASE procedure 4-31
- error message, device A-3
- error messages A-8
- error, recover from A-7
- external commands 1-6

## F

- file compare 4-19
- file delete 4-30

- file specifications 2-6
- file, backing-up one 4-16
- file, copy to a diskette 4-17
- file, display what's in 4-26
- filename, change a 4-28
- files/filenames, what are 2-3
- finding out what's on a diskette 4-23
- FORMAT procedure 4-6
- FORMAT, how to use 4-5
- formatting diskettes, how to 4-6
- formatting your diskettes 1-10
- function keys 2-7

## G

- getting a diskette ready 4-5
- getting DOS started 3-3
- giving DOS a command 3-7
- giving file a name 2-3

## H

- helps and hints 4-32
- how to insert diskettes 3-3
- how to locate files 2-6
- how to name files 2-3

## I

- inserting diskettes 3-3
- internal commands 1-6

## K

keyboards, 62 and 83  
keys 2-7  
keys, function 2-7

## L

list diskette files 4-23  
listing, print a 2-13  
loading DOS 3-3  
locating filenames 2-6

## M

messages A-3, A-8  
messages, about 1-11

## N

naming your files 2-3  
notch, write-protect 1-9

## O

one drive systems, how to  
use 1-9

## P

Pause Screen function  
keys 2-11  
print listing 2-13

Print Screen function  
keys 2-12  
Print what you type 2-13  
Printer Echo function  
keys 2-13  
printing the screen 2-12  
prompt 3-7  
protect notch 1-10

## R

recover from error A-7  
remove a file from  
diskette 4-30  
removing a file 4-30  
RENAME procedure 4-29  
reset DOS 3-4  
responses to the computer A-7  
retry read/write operation A-7

## S

screen, print 2-12  
single diskette-drive systems,  
how to use 1-9  
specifications, filenames 2-6  
specifier, drive 2-6  
specifying the drive 3-8  
starting DOS 3-3  
starting DOS again 2-14  
starting your computer with  
DOS 3-3  
stopping the screen 2-11  
system reset 3-4  
System Reset function  
keys 2-14  
system, what do you have 1-7

## T

target diskette compare 4-12  
To List All the Files 4-23  
two drive systems, how  
to use 1-9  
TYPE procedure 4-27

## U

using DOS commands 4-3  
using the COMP  
command 4-19  
Using the DIR  
Command 4-23

Using the ERASE  
command 4-30  
Using the RENAME  
Command 4-28  
Using the TYPE  
command 4-26

## W

what system do you have 1-7  
what's in a file 4-26  
what's on a diskette 4-23  
when DOS is ready 3-7  
write-protect 1-10



Programming Series 110180-0 Printed in Japan  
JX PC DOS Version 2.10 User's Guide

