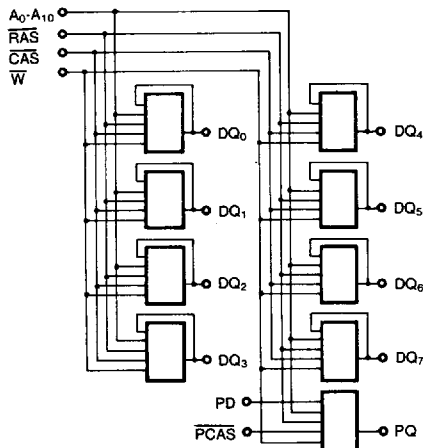

**KMM594000A****DRAM MODULES****4Mx9 CMOS DRAM SIMM Memory Module****FEATURES**

- Performance range:

	t <sub>RAC</sub>	t <sub>CAC</sub>	t <sub>RC</sub>
KMM594000A- 7	70ns	20ns	130ns
KMM594000A- 8	80ns	20ns	150ns
KMM594000A-10	100ns	25ns	180ns

- Fast Page Mode operation
- CAS-before-RAS refresh capability
- RAS-only and Hidden refresh capability
- TTL compatible inputs and outputs
- Single +5V ±10% power supply
- 1024 cycles/16ms refresh
- JEDEC standard pinout

**FUNCTIONAL BLOCK DIAGRAM**

Pin Name	Pin Function
A <sub>0</sub> -A <sub>10</sub>	Address Inputs
DQ <sub>0</sub> -7	Data In/Out
$\bar{W}$	Read/Write Input
RAS	Row Address Strobe
CAS	Column Address Strobe
PCAS	CAS for Parity
PD	Data In for Parity
PQ	Data Out for Parity
V <sub>CC</sub>	Power (+5V)
V <sub>SS</sub>	Ground
N.C.	No connection

**GENERAL DESCRIPTION**

The Samsung KMM594000A is a 4M bit × 9 Dynamic RAM high density memory module. The Samsung KMM594000A consist of nine KM41C4000AJ DRAMs in 20-pin SOJ package mounted on a 30-pin glass-epoxy substrate. A 0.22μF decoupling capacitor is mounted under each 4M Bit DRAM.

The KMM594000A is a Single In-line Memory Module with edge connections and is intended for mounting into 30-pin edge connector sockets.

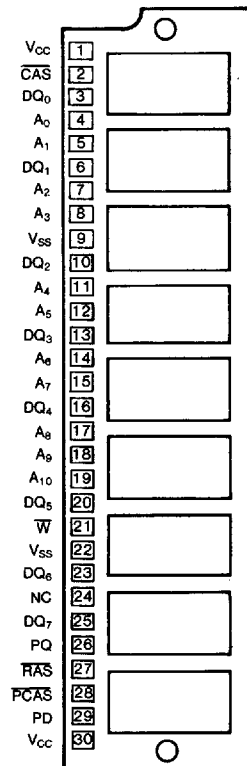
**PIN CONFIGURATIONS**

**KMM594000A****DRAM MODULES****ABSOLUTE MAXIMUM RATINGS\***

Item	Symbol	Rating	Units
Voltage on Any Pin Relative to V <sub>SS</sub>	V <sub>IN</sub> , V <sub>OUT</sub>	-1 to +7.0	V
Voltage on V <sub>CC</sub> Supply Relative to V <sub>SS</sub>	V <sub>CC</sub>	-1 to +7.0	V
Storage Temperature	T <sub>stg</sub>	-55 to +150	°C
Power Dissipation	P <sub>D</sub>	5.4	W
Short Circuit Output Current	I <sub>OS</sub>	50	mA

\* Permanent device damage may occur if "ABSOLUTE MAXIMUM RATINGS" are exceeded. Functional Operation should be restricted to the conditions as detailed in the operational sections of this data sheet. Exposure to absolute maximum rating conditions for extended periods may affect device reliability.

**RECOMMENDED OPERATING CONDITIONS** (Voltage reference to V<sub>SS</sub>, T<sub>A</sub>=0 to 70°C)

Item	Symbol	Min	Typ	Max	Unit
Supply Voltage	V <sub>CC</sub>	4.5	5.0	5.5	V
Ground	V <sub>SS</sub>	0	0	0	V
Input High Voltage	V <sub>IH</sub>	2.4	—	V <sub>CC</sub> +1	V
Input Low Voltage	V <sub>IL</sub>	-1.0	—	0.8	V

**DC AND OPERATING CHARACTERISTICS**

(Recommended operating conditions unless otherwise noted.)

Parameter	Symbol	Min	Max	Units
Operating Current* (RAS, CAS, Address Cycling @ t <sub>RC</sub> =min.)	KMM594000A- 7	—	945	mA
	KMM594000A- 8	—	855	mA
	KMM594000A-10	—	765	mA
Standby Current (RAS=CAS=V <sub>IH</sub> )	I <sub>CC2</sub>	—	18	mA
RAS-Only Refresh Current* (CAS=V <sub>IH</sub> , RAS Cycling @ t <sub>RC</sub> =min)	KMM594000A- 7	—	945	mA
	KMM594000A- 8	—	855	mA
	KMM594000A-10	—	765	mA
Fast Page Mode Current* (RAS=V <sub>IL</sub> , CAS Cycling: t <sub>PC</sub> =min.)	KMM594000A- 7	—	720	mA
	KMM594000A- 8	—	630	mA
	KMM594000A-10	—	540	mA
Standby Current (RAS=CAS=V <sub>CC</sub> -0.2V)	I <sub>CC5</sub>	—	9	mA
CAS-Before-RAS Refresh Current* (RAS and CAS Cycling @ t <sub>RC</sub> =min.)	KMM594000A- 7	—	945	mA
	KMM594000A- 8	—	855	mA
	KMM594000A-10	—	765	mA
Input Leakage Current (Any input 0≤V <sub>IN</sub> ≤6.5V, all other pins not under test=0 volts.)	I <sub>IL</sub>	-90	90	μA
Output Leakage Current (Data out is disabled, 0≤V <sub>OUT</sub> ≤5.5V)	I <sub>OL</sub>	-10	10	μA
Output High Voltage Level (I <sub>OH</sub> =-5mA)	V <sub>OH</sub>	2.4	—	V
Output Low Voltage Level (I <sub>OL</sub> =4.2mA)	V <sub>OL</sub>	—	0.4	V

\*NOTE: I<sub>CC1</sub>, I<sub>CC3</sub>, I<sub>CC4</sub> and I<sub>CC6</sub> are dependent on output loading and cycle rates. Specified values are obtained with the output open. I<sub>CC</sub> is specified as average current.

## KMM594000A

## DRAM MODULES

CAPACITANCE ( $T_A=25^\circ\text{C}$ )

Item	Symbol	Min	Max	Unit
Input Capacitance ( $A_0$ - $A_{10}$ )	$C_{IN1}$	—	55	pF
Input Capacitance ( $\overline{RAS}$ , $\overline{CAS}$ , $\overline{W}$ )	$C_{IN2}$	—	65	pF
Input Capacitance ( $PD$ , $\overline{PCAS}$ )	$C_{IN3}$	—	10	pF
Input/Output Capacitance ( $DQ_0$ - $DQ_7$ )	$C_{DQ}$	—	15	pF
Output Capacitance ( $PQ$ )	$C_Q$	—	10	pF

AC CHARACTERISTICS ( $0^\circ\text{C}\leq T_A\leq 70^\circ\text{C}$ ,  $V_{CC}=5.0V\pm 10\%$ , See notes 1,2)

Standard Operation	Symbol	KMM594000A-7		KMM594000A-8		KMM594000A-10		Unit	Notes
		Min	Max	Min	Max	Min	Max		
Random read or write cycle time	$t_{RC}$	130		150		180		ns	
Access time from $\overline{RAS}$	$t_{RAC}$		70		80		100	ns	3,4
Access time from $\overline{CAS}$	$t_{CAC}$		20		20		25	ns	3,4,5
Access time from column address	$t_{AA}$		35		40		50	ns	3,11
$\overline{CAS}$ to output in Low-Z	$t_{CLZ}$	5		5		5		ns	3
Output buffer turn-off delay	$t_{OFF}$	0	15	0	15	0	20	ns	7
Transition time (rise and fall)	$t_T$	3	50	3	50	3	50	ns	2
$\overline{RAS}$ precharge time	$t_{RP}$	50		60		70		ns	
$\overline{RAS}$ pulse width	$t_{RAS}$	70	10,000	80	10,000	100	10,000	ns	
$\overline{RAS}$ hold time	$t_{RSH}$	20		20		25		ns	
$\overline{CAS}$ hold time	$t_{CSH}$	70		80		100		ns	
$\overline{CAS}$ pulse width	$t_{CAS}$	20	10,000	20	10,000	25	10,000	ns	
$\overline{RAS}$ to $\overline{CAS}$ delay time	$t_{RCD}$	20	50	20	60	25	75	ns	4
$\overline{RAS}$ to column address delay time	$t_{RAD}$	15	35	15	40	20	50	ns	11
$\overline{CAS}$ to $\overline{RAS}$ precharge time	$t_{CRP}$	5		5		10		ns	
Row address set-up time	$t_{ASR}$	0		0		0		ns	
Row address hold time	$t_{RAH}$	10		10		15		ns	
Column address set-up time	$t_{ASC}$	0		0		0		ns	
Column address hold time	$t_{CAH}$	15		15		20		ns	
Column address hold referenced to $\overline{RAS}$	$t_{AR}$	55		60		75		ns	6
Column Address to $\overline{RAS}$ lead time	$t_{RAL}$	35		40		50		ns	
Read command set-up time	$t_{RCS}$	0		0		0		ns	
Read command hold referenced to $\overline{CAS}$	$t_{RCH}$	0		0		0		ns	9
Read command hold referenced to $\overline{RAS}$	$t_{RRH}$	0		0		0		ns	9
Write command hold time	$t_{WCH}$	15		15		20		ns	
Write command hold referenced to $\overline{RAS}$	$t_{WCR}$	55		60		75		ns	6
Write command pulse width	$t_{WP}$	15		15		20		ns	
Write command to $\overline{RAS}$ lead time	$t_{RWL}$	20		20		25		ns	
Write command to $\overline{CAS}$ lead time	$t_{CWL}$	20		20		25		ns	
Data-in set-up time	$t_{DS}$	0		0		0		ns	10

## KMM594000A

## DRAM MODULES

## AC CHARACTERISTICS (Continued)

Standard Operation	Symbol	KMM594000A-7		KMM594000A-8		KMM594000A-10		Unit	Notes
		Min	Max	Min	Max	Min	Max		
Data-in hold time	$t_{DH}$	15		15		20		ns	10
Data-in hold referenced to $\overline{RAS}$	$t_{DHR}$	55		60		75		ns	6
Refresh period	$t_{REF}$		16		16		16	ms	
Write command set-up time	$t_{WCS}$	0		0		0		ns	8
$\overline{CAS}$ setup time (C-B-R refresh)	$t_{CSR}$	10		10		10		ns	
$\overline{CAS}$ hold time (C-B-R refresh)	$t_{CHR}$	20		30		30		ns	
$\overline{RAS}$ precharge to $\overline{CAS}$ hold time	$t_{RPC}$	10		10		10		ns	
Access time from $\overline{CAS}$ precharge	$t_{CPA}$		45		45		55	ns	3
Fast Page mode cycle time	$t_{PC}$	50		50		60		ns	
$\overline{CAS}$ precharge time (Fast page)	$t_{CP}$	10		10		10		ns	
$\overline{RAS}$ pulse width (Fast page)	$t_{RASP}$	70	200,000	80	200,000	100	200,000	ns	

## NOTES

1. An initial pause of 200 $\mu$ s is required after power-up followed by any 8  $\overline{RAS}$  cycles before proper device operation is achieved.
2.  $V_{IH(min)}$  and  $V_{IL(max)}$  are reference levels for measuring timing of input signals. Transition times are measured between  $V_{IH(min)}$  and  $V_{IL(max)}$ , and are assumed to be 5ns for all inputs.
3. Measured with a load equivalent to 2 TTL loads and 100pF
4. Operation within the  $t_{RCD(max)}$  limit insures that  $t_{RAC(max)}$  can be met.  $t_{RCD(max)}$  is specified as a reference point only. If  $t_{RCD}$  is greater than the specified  $t_{RCD(max)}$  limit, then access time is controlled exclusively by  $t_{CAC}$ .
5. Assumes that  $t_{RCD} \geq t_{RCD(max)}$ .
6.  $t_{AR}$ ,  $t_{WCR}$ ,  $t_{DHR}$  are referenced to  $t_{RAD(max)}$ .
7. This parameter defines the time at which the output achieves the open circuit condition and is not referenced to  $V_{OH}$  or  $V_{OL}$ .
8.  $t_{WCS}$ ,  $t_{RWD}$ ,  $t_{CWD}$  and  $t_{AWD}$  are non restrictive operating parameters. They are included in the data sheet as electrical characteristics only. If  $t_{WCS} \geq t_{WCS(min)}$  the cycle is an early write cycle and the data out pin will remain high impedance for the duration of the cycle.
9. Either  $t_{RCH}$  or  $t_{RRH}$  must be satisfied for a read cycle.
10. These parameters are referenced to the  $\overline{CAS}$  leading edge in early write cycles and to the  $\overline{W}$  leading edge in read-write cycles.
11. Operation within the  $t_{RAD(max)}$  limit insures that  $t_{RAC(max)}$  can be met.  $t_{RAD(max)}$  is specified as a reference point only. If  $t_{RAD}$  is greater than the specified  $t_{RAD(max)}$  limit, then access time is controlled by  $t_{AA}$ .

KMM594000A

DRAM MODULES

TIMING DIAGRAMS

READ CYCLE

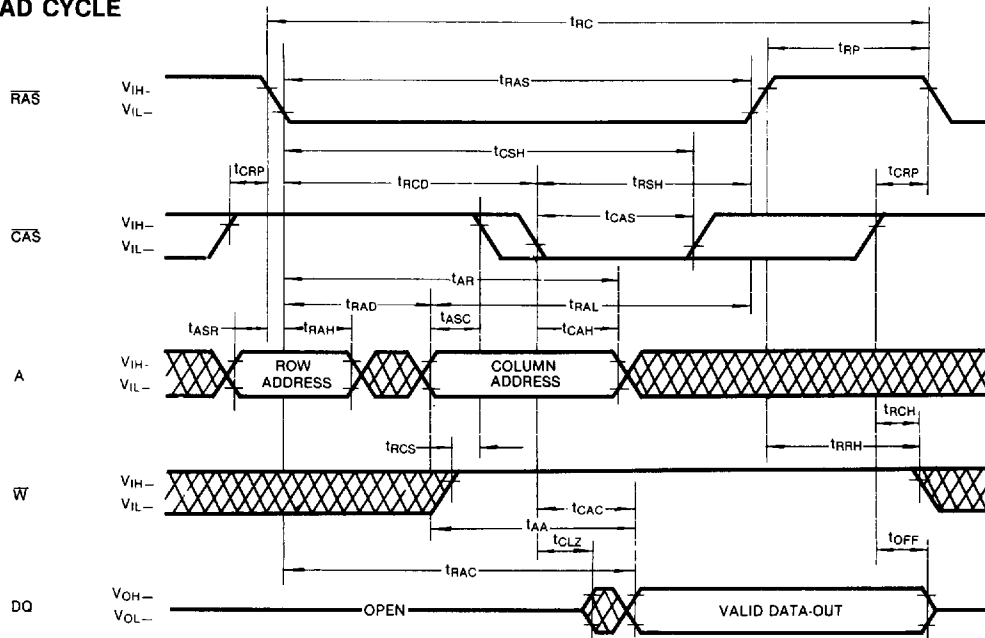

WRITE CYCLE (EARLY WRITE)

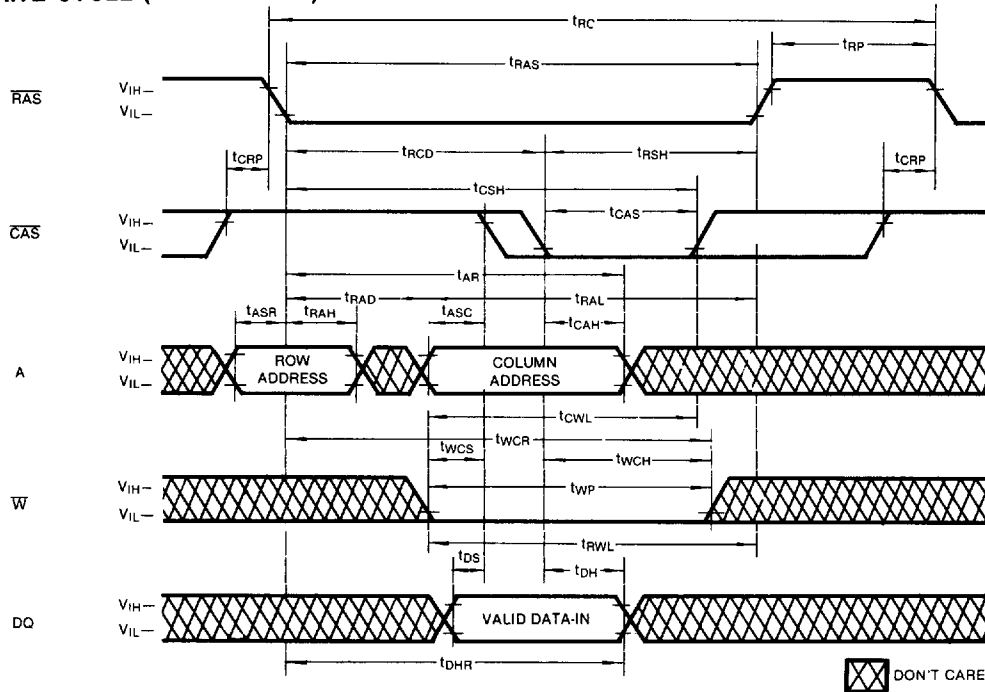

2



## KMM594000A

## DRAM MODULES

## TIMING DIAGRAMS (Continued)

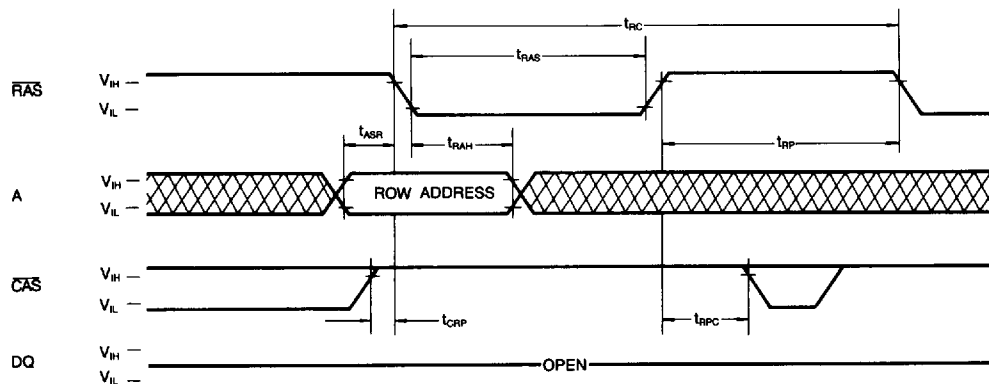
**RAS-ONLY REFRESH CYCLE**Note:  $\bar{W}$  = Don't Care**CAS-BEFORE-RAS REFRESH CYCLE**

NOTE: Address = Don't Care

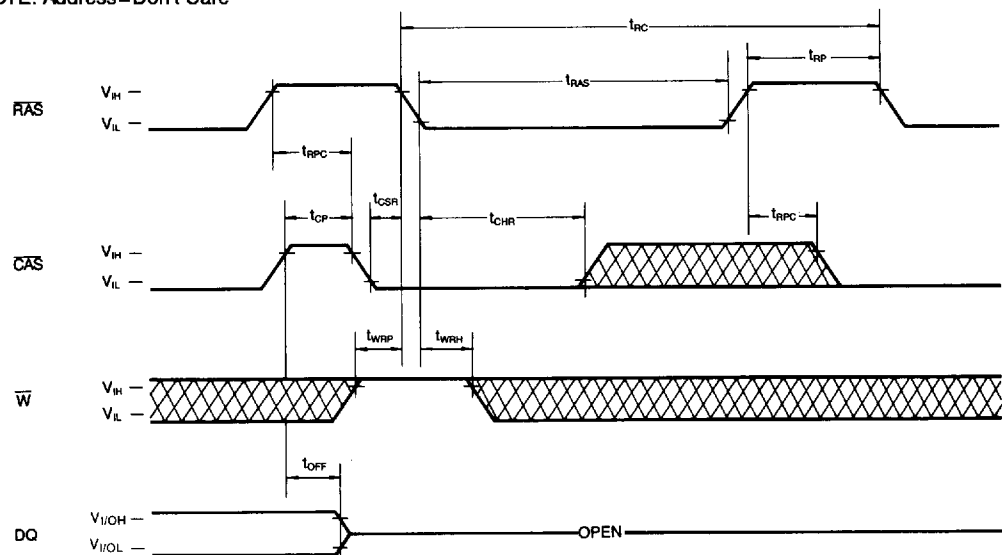

DON'T CARE

**KMM594000A**

**DRAM MODULES**

**TIMING DIAGRAMS (Continued)**

**HIDDEN REFRESH CYCLE (READ)**

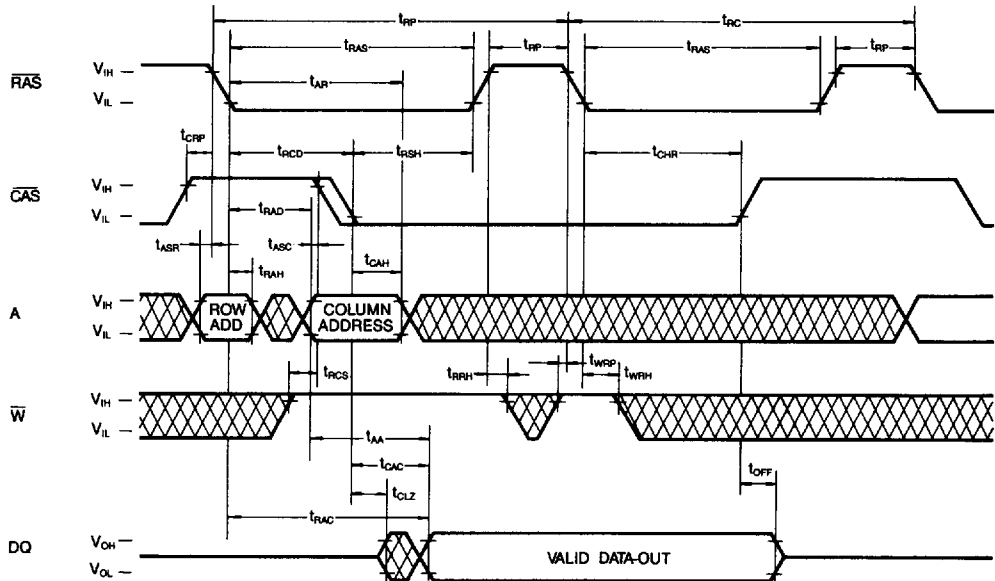

**HIDDEN REFRESH CYCLE (WRITE)**

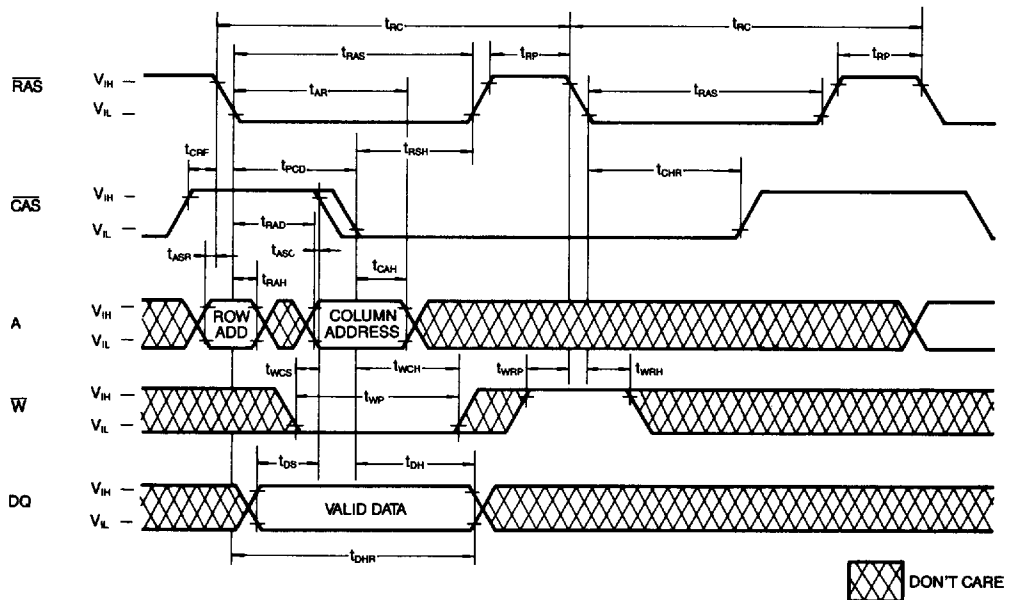



## KMM594000A

## DRAM MODULES

## TIMING DIAGRAMS (Continued)

## CAS-BEFORE-RAS REFRESH COUNTER TEST CYCLE

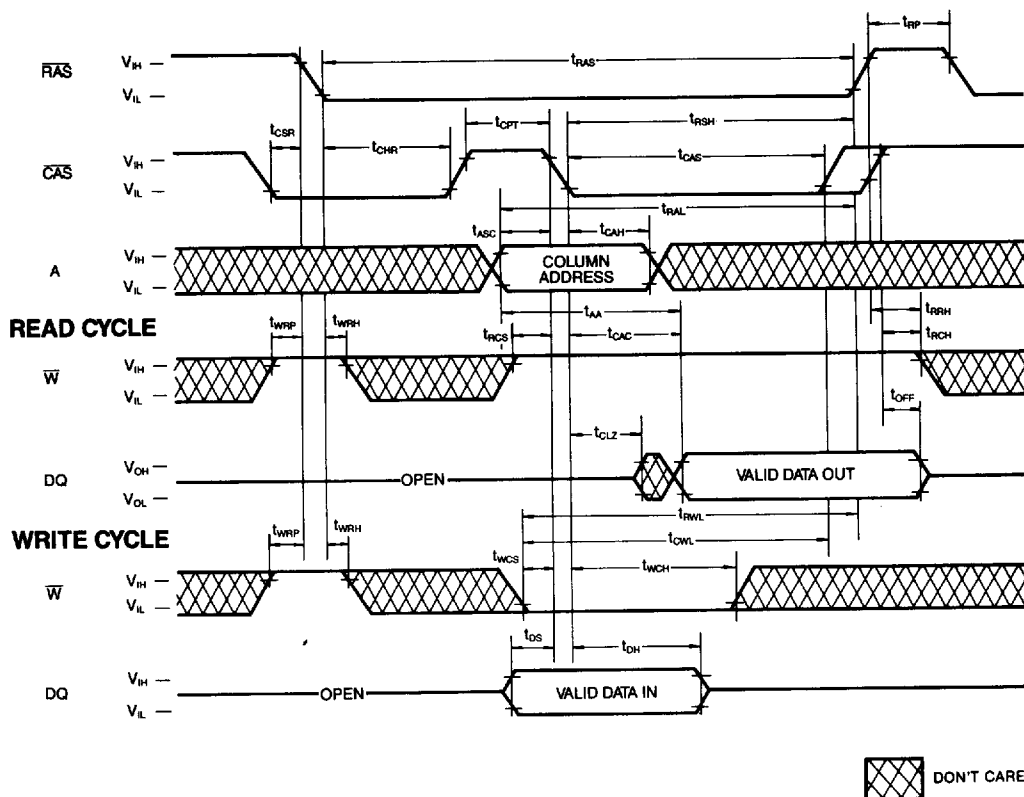

# KMM594000A

# DRAM MODULES

## PACKAGE DIMENSIONS

Units: Inches (millimeters)

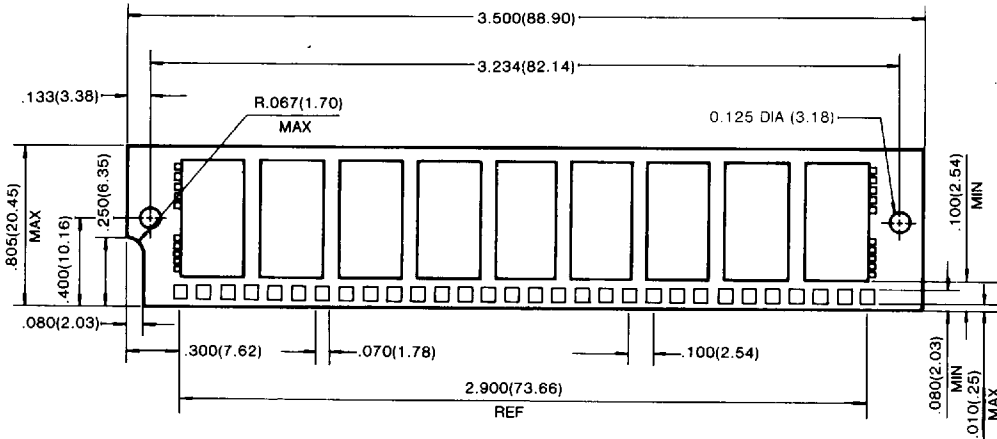

Tolerances: ±.005(.13) unless otherwise specified

