

Supplemental Information for:

# Adapters, Devices, and Cable Information for Multiple Bus Systems

This supplement is for form number SA23-2778-04, (October 1997)

## 2.1GB SCSI-2 Disk Drive

The 2.1GB SCSI-2 disk drive has a 3.5 inch form factor and mounts in a half-height media position.

### Setting the SCSI Address Jumpers

**Note:** The device is shown with jumpers configured for SCSI Address 6.

The SCSI address of the 2.1GB SCSI-2 disk drive is set by jumpers located on the logic card. Use the following diagram and the SCSI address table on page 3 to set the jumpers.

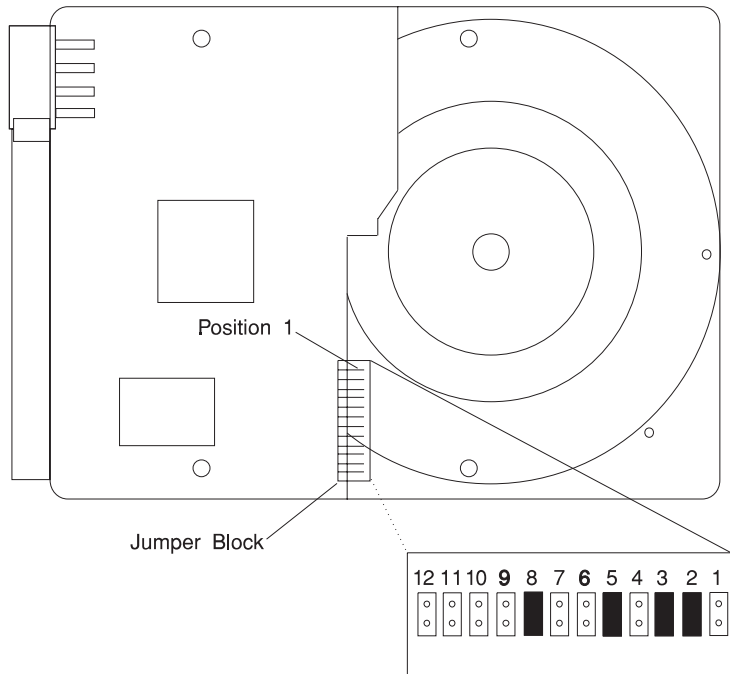

- Positions 5, and 8 must have jumpers.
- Positions 1, 6, 7, 9, 10, 11, and 12 must not have jumpers.

## 4.5GB SCSI-2 Disk Drive - Type F1

The 4.5GB SCSI-2 disk drive has a 3.5 inch form factor and mounts in a half-height media position. See table in section “1.1GB, 2.2GB, 4.5GB, 9.1GB, (50 and 68-pin) Single-Ended Disk Drives” on page 4 for description of disk drive Type - F1.

### Setting the SCSI Address Jumpers

**Note:** The device is shown with jumpers configured for SCSI Address 6.

The SCSI address of the 4.5GB SCSI-2 disk drive is set by jumpers located on the logic card. Use the following diagram and the SCSI address table on page 3 to set the jumpers.

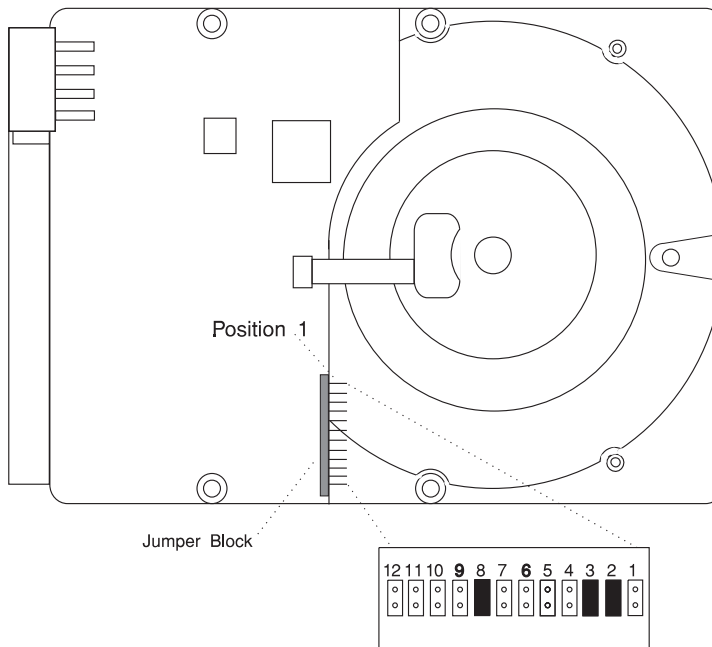

- Position 8 must have a jumper.
- Positions 5, 6, 7, 9, 10, 11, and 12 must not have jumpers.

## SCSI Address Table

Address	Jumper 4	Jumper 3	Jumper 2	Jumper 1
0	Off	Off	Off	Off
1	On	Off	Off	Off
2	Off	On	Off	Off
3	On	On	Off	Off
4	Off	Off	On	Off
5	On	Off	On	Off
6	Off	On	On	Off
7	On	On	On	Off
8	Off	Off	Off	On
9	On	Off	Off	On
10	Off	On	Off	On
11	On	On	Off	On
12	Off	Off	On	On
13	On	Off	On	On
14	Off	On	On	On
15	On	On	On	On

**Note:**

1. Address 7 is reserved for the adapter.
2. There is no jumper 1 on 50 pin drives, thus SCSI addresses eight to fifteen are not valid.

## 1.1GB, 2.2GB, 4.5GB, 9.1GB, (50 and 68-pin) Single-Ended Disk Drives

There are many different types of the SCSI-2 Disk Drives. Before you can set the SCSI address, you must determine which type of SCSI-2 disk drive you have. The table below describes the various features of each drive to help you do this.

Type	Form Factor	Capacity in GB	SCSI Conn Pins	Required Jumper(s)	Jumper Block Pins	Drive Type
A1	1"	1.1/2.2	50-pin	23-24 <sup>1</sup>	32	DFHS/DFMS
A2	1"	1.1/2.2	68-pin	23-24 <sup>1</sup>	32	DFHS/DFMS
A3	1.6"	4.5	68-pin	23-24 <sup>1</sup>	32	DFHS/DFMS
B1	1"	1.1/2.2	50-pin	None	20	Quantum
B2	1"	1.1/2.2	68-pin	None	12	Quantum
B3	1.6"	4.5	68-pin	None	12	Quantum
C1	1"	2.2	50-pin	None	32	DCHS
C2	1"	2.2	68-pin	None	32	DCHS
C3	1"	4.5	68-pin	23-24 & 31-32 <sup>2</sup>	32	DCHS
C4	1.6"	9.1	68-pin	23-24 & 31-32 <sup>2</sup>	32	DCHS
D1	1"	2.2/4.5	68-pin	31-32 <sup>2</sup>	32	Quantum
D2	1.6"	9.1	68-pin	31-32 <sup>2</sup>	32	Quantum
D3	1"	2.2	68-pin	23-24 & 31-32 <sup>2</sup>	32	Quantum
E1	1"	9.1	68-pin	None	32	DGHS
F1	1"	4.5	68-pin	Note <sup>3</sup>	-	DDRS

### Notes:

<sup>1</sup>Factory installed jumpers

<sup>2</sup>Customer or customer representative installed jumpers.

<sup>3</sup>See jumper setting information in "4.5GB SCSI-2 Disk Drive - Type F1" on page 2.

Other differences to look for are the number jumper block pins, and SCSI connector size.

---

## SCSI-2 disk drives

The following figures show the location of the jumper blocks and where to place the jumpers to set the SCSI address or SCSI ID. There are three jumpers to set on 50-pin models and four on 68-pin models.

### Setting the SCSI address or SCSI ID

To set the SCSI address or SCSI ID see the Valid Addresses (SCSI IDs) table on page 14.

**Type A1 Drive:** For 1.1GB, and 2.2GB drives, 50-pin models.

**Note:** Type A disk drives are shipped with one factory installed jumper. Do not change the factory installed jumper.

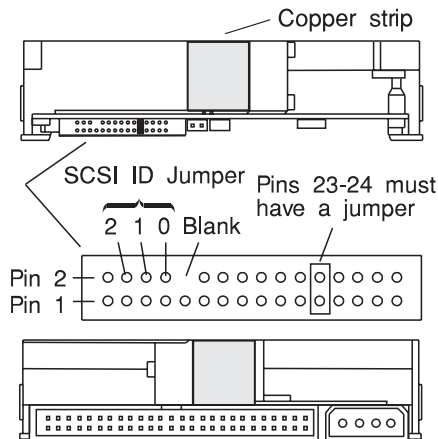

**Type A2 Drive:** For 1.1GB, and 2.2GB drives, 68-pin models.

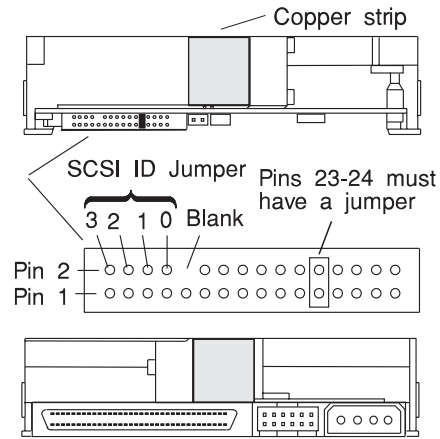

**Type A3 Drive:** For 4.5GB drives, 68-pin model.

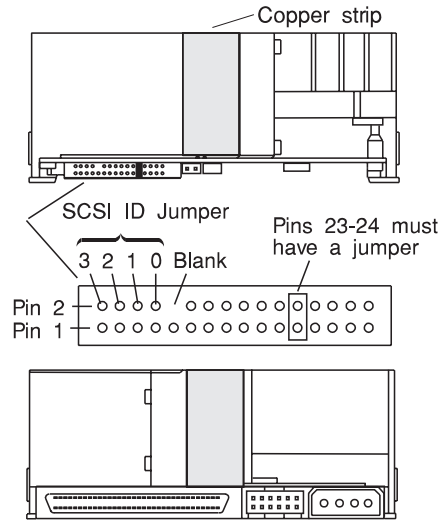

**Type B1 Drive:** For 1.1GB, and 2.2GB drives, 50-pin models.

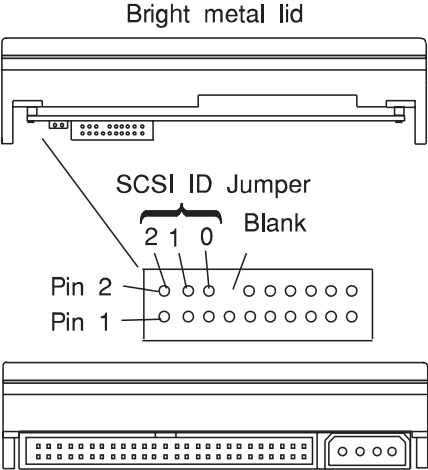

**Type B2 Drive:** For 1.1GB, and 2.2GB drives, 68-pin models.

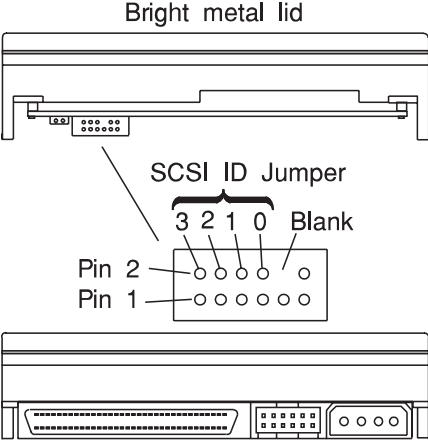



**Type B3 Drive:** For 4.5GB drives, 68-pin model.

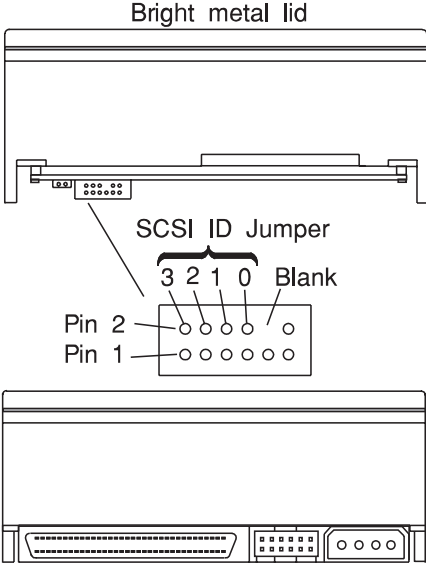

**Type C1 Drive**

For 2.2GB drives, 50-pin model.

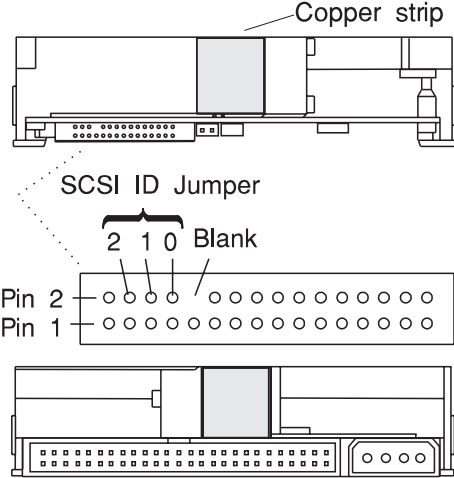

# Type C2 Drive

For 2.2GB drives, 68-pin model.

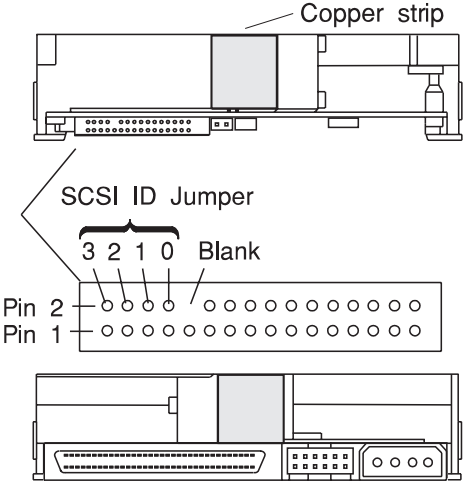

**Type C3 Drive:** For 4.5GB drives, 68-pin model.

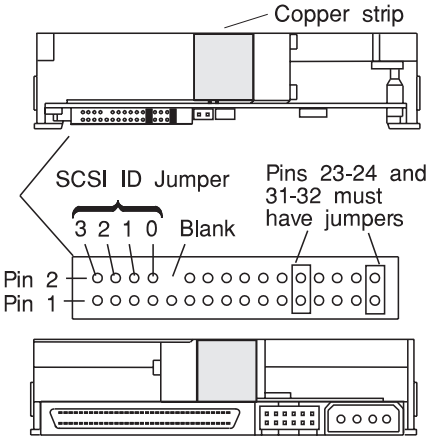

**Type C4 Drive:** For 9.1GB drives, 68-pin model.

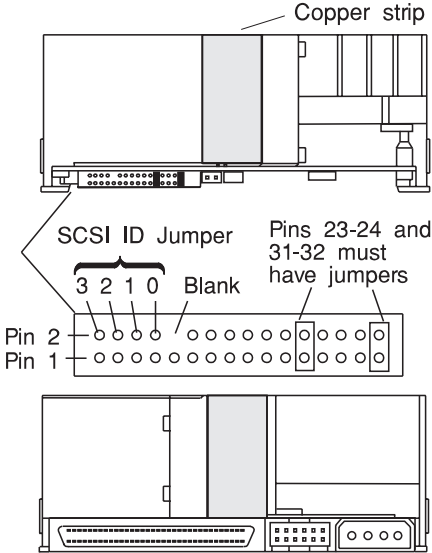

**Type D1 Drive:** For 2.2GB and 4.5GB drives, 68-pin models.

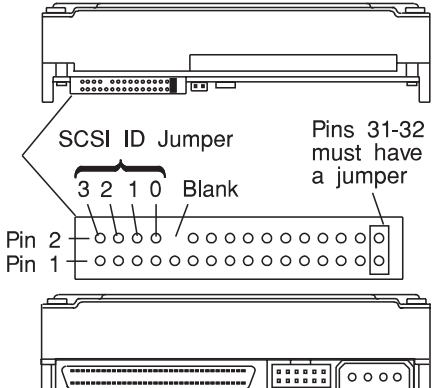

**Type D2 Drive:** For 9.1GB drives, 68-pin models.

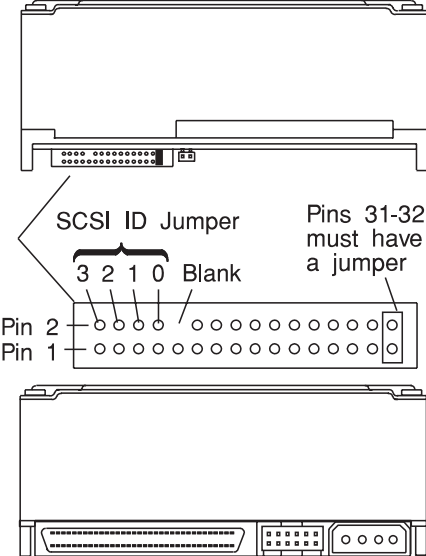

**Type D3 Drive:** The type D1 2.2GB, 68-pin (16-bit) disk drive can be used as a 50-pin (8-bit) drive by adding a jumper.

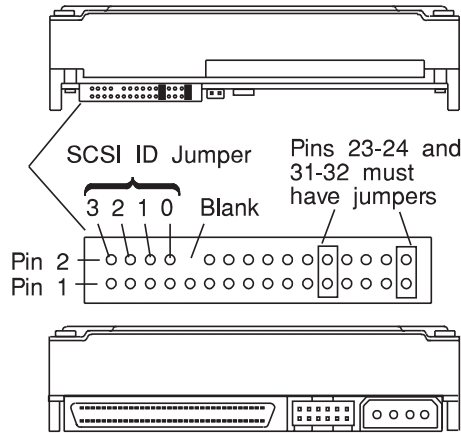

- Pins 23 and 24 must be jumpered together as shown in the figure above.
- Jumper 3 on pins 1 to 2 is not used in this configuration. Do not place a jumper on these pins. Eight bit devices can only use SCSI ID's zero (0) through six (6).
- Some systems require a 68-pin to 50-pin interposer, a cable and interposer or an interposer cable as shown below.

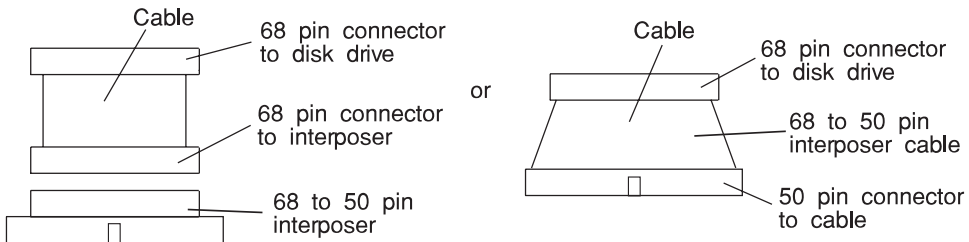

- When this disk drive is used on a Machine Type 7015 Models R20, R30, R40, or R50, the terminator power jumper (2.5 mm) must be installed. See figure below.

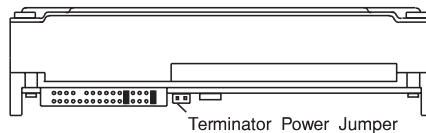

**Type E1 Drive:** For 9.1GB drive, 68-pin model.

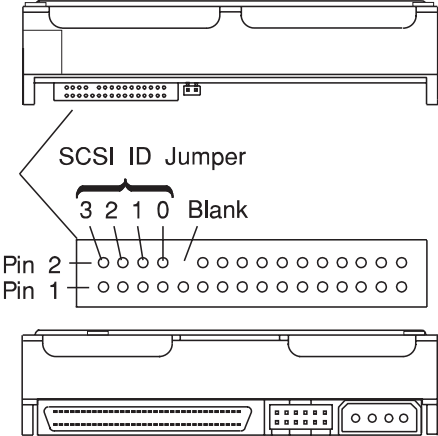

## Valid Addresses (SCSI IDs)

Address	Jumper 3	Jumper 2	Jumper 1	Jumper 0
0	Off	Off	Off	Off
1	Off	Off	Off	On
2	Off	Off	On	Off
3	Off	Off	On	On
4	Off	On	Off	Off
5	Off	On	Off	On
6	Off	On	On	Off
7*	Off	On	On	On
8	On	Off	Off	Off
9	On	Off	Off	On
10	On	Off	On	Off
11	On	Off	On	On
12	On	On	Off	Off
13	On	On	Off	On
14	On	On	On	Off
15	On	On	On	On

### Note:

1. Address 7 is reserved for the adapter.
2. There is no jumper 3 on 50 pin drives, thus SCSI addresses eight to fifteen are not valid.

## Keyboard

The following drawing shows the keyboard attached to the standard I/O port K. The keyboard cable is supplied with the keyboard.

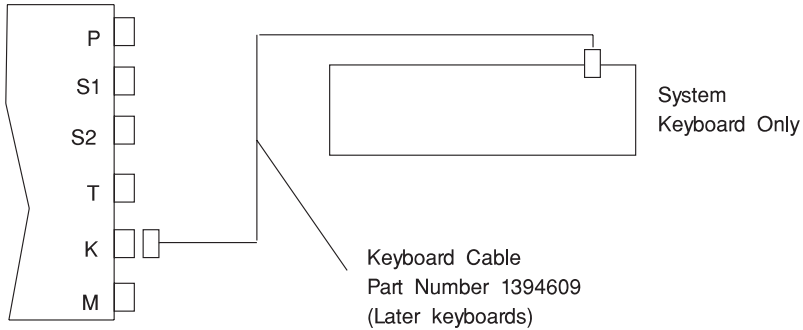

## Speaker and Keyboard

Some systems were shipped that did not have a speaker in the keyboard or the system unit. The following drawing shows the keyboard attached to a speaker box with a 3 ft. cable which attaches to the standard I/O port K. The speaker box has a keyboard connector to pass the keyboard signals through to the keyboard. The keyboard cable is supplied with the keyboard.

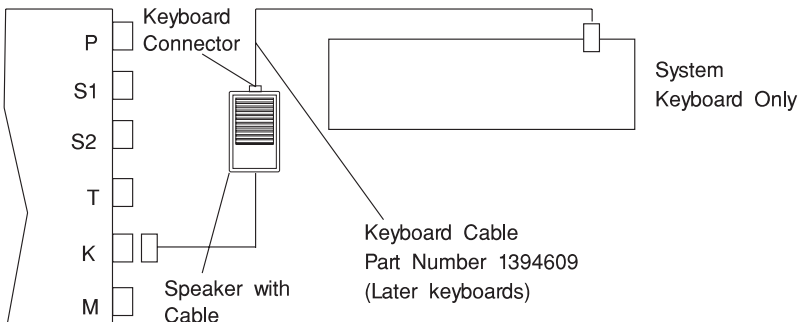



## CSU/CE Feature Installation

**Attention:** The following information is to indicate which features on various systems/models are intended to be installed by the customer and which features are to be installed by a Customer Engineer/Customer Service Representative (CE/CSR) as part on a Miscellaneous Equipment Specification (MES). This information is for systems/models available as of 02/98.

**Note:** The acronym CSU means Customer Set-Up.

Machine Type	Model	System CSU	Features/Options	
			CE Install	Customer Install
7006	(ALL)	YES	ALL FEATURES	NONE
7007	(ALL)	YES	ALL FEATURES	NONE
7008	(ALL)	YES	ALL FEATURES	NONE
7009	(ALL)	YES	ALL FEATURES	NONE
7010	(ALL)	YES	ALL FEATURES	NONE
7011	(ALL)	YES	ALL FEATURES	NONE
7012	(ALL)	YES	ALL FEATURES	NONE
7013	(ALL) <sup>1</sup>	NO	ALL FEATURES	NONE
7015	(ALL)	NO	ALL FEATURES	NONE
7024	(ALL)	YES	FC 6309	ALL OTHER FEATURES
7025	(ALL)	YES	FC 2856, 6309, 6549	ALL OTHER FEATURES
7026 <sup>2</sup>	(ALL)	NO	ALL OTHER FEATURES	FC 2901, 2911, 2913 3071, 3072, 3083
7027	(ALL)	NO	ALL OTHER FEATURES	FC 2616, 3080,3083 3084, 3090, 6142 6147, 3133, 3134 3137, 3138, 6153 6294, 6295
7043	(ALL)	YES	FC 2856 & 6309	ALL OTHER FEATURES
7236	(ALL)	NO	ALL FEATURES	NONE
7248	(ALL)	YES	FC 2856	ALL OTHER FEATURES
7317	(ALL)	NO	ALL FEATURES	NONE
7318	(ALL)	NO	ALL FEATURES	NONE
7319	(ALL)	NO	ALL FEATURES	NONE
Enterprise Servers	S70	NO	ALL FEATURES	NONE

**Note:**

1. 7013 J30 was announced as CSU. US practice has been for savenstall.
2. Some Machine Type 7026 Models have Enterprise Server in their name.

Part Number: 07L8301

Printed in U.S.A.

