

Rampage[®] 286
Expanded Memory Card
for the
IBM Personal Computer
AT[®] and XT[™] Model 286

User's Manual
000432-001 A
December 1986

WARNING

This manual and software are both protected by United States Copyright law (Title 17 United States Code). Unauthorized reproduction, distribution, or any other use of this manual or software without the prior written permission of AST Research, Inc. is prohibited. AST Research, Inc. reserves the right to change the information in this manual without notice.

AST Research, Inc.
Irvine, California
(714) 863-1333

First Edition (December 1986)

AST and Rampage are registered trademarks of AST Research, Inc. Premium-Pak AT, Advantage Premium, SuperPak, SuperDrive, SuperSpool, fASTdisk, *Advantage!* and RAMVantage! are trademarks of AST Research, Inc. IBM and AT are registered trademarks of International Business Machines Corporation. DESQview is a trademark of Quarterdeck Office Systems. Ashton-Tate and Framework II are trademarks of Ashton-Tate Corporation. Lotus, 1-2-3, and Symphony are trademarks of Lotus Development Corporation. XENIX is a trademark of Microsoft Corporation.

AST Research periodically changes the information in this manual; changes are incorporated into new editions. AST Research reserves the right to modify this product's design.

In view of demonstrated product reliability and comprehensive warranty policies, AST Research, Inc. does not normally provide schematics or material lists. AST recognizes that some customers with a large installed base of AST products want supportive documentation for their own service organizations. In such cases, customers should contact AST Research corporate offices to consider an appropriate nondisclosure agreement to obtain this documentation.

A Product Comment Form is provided at the back of this publication. If this form has been removed, please address your comments to: AST Research, Inc., Attn: Product Marketing, 2121 Alton Avenue, Irvine, CA 92714. AST Research may use or distribute any of the information you supply in any way it deems appropriate without incurring any obligations whatsoever.

Copyright © 1986 AST Research, Inc. All rights are reserved, including those to reproduce this book or parts thereof in any form without permission in writing from AST Research, Inc.

WARNING

This manual and software are both protected by United States Copyright law (Title 17 United States Code). Unauthorized reproduction and/or sales may result in imprisonment of up to one year and fines of up to \$10,000 (17 USC 506). Copyright infringers may be subject to civil liability.

CONTENTS

| | |
|--|------|
| SECTION 1. INTRODUCTION | 1-1 |
| 1.1 Features | 1-2 |
| 1.1.1 Hardware Features | 1-3 |
| 1.1.2 Software Features | 1-4 |
| 1.2 Example Memory Allocation | 1-5 |
| 1.3 Getting Started | 1-8 |
| 1.4 Checklist | 1-10 |
| 1.5 System Requirements | 1-10 |
| 1.6 How To Use This Manual | 1-11 |
| 1.6.1 Format Notation | 1-11 |
| 1.6.2 Related Documentation | 1-12 |
| 1.6.3 Manual Outline | 1-12 |
| SECTION 2. CONFIGURING YOUR RAMPAGE 286 BOARD | 2-1 |
| 2.1 Default Configuration | 2-1 |
| 2.2 Basic Configuration | 2-4 |
| 2.2.1 What You Need to Know Before You Start | 2-4 |
| 2.2.2 SW1 Location and Default Settings | 2-6 |
| 2.2.3 Conventional/Extended Memory Size Setting (SW1-1 through SW1-4) | 2-7 |
| 2.2.4 Base I/O Address Settings (SW1-5 through SW1-8) | 2-10 |
| 2.2.5 Dual Page Mode (SW1-9) | 2-11 |
| 2.2.6 SW2 Location and Default Settings | 2-11 |
| 2.2.7 Conventional/Extended Memory Installed (SW2-1 through SW2-7) | 2-12 |
| 2.2.8 Parity Checking (SW2-8) | 2-14 |

CONTENTS

| | |
|--|------|
| SECTION 3. INSTALLING RAMPAGE 286 IN YOUR PC-AT | 3-1 |
| 3.1 Opening Your PC-AT | 3-1 |
| 3.2 Installing RAMpage 286 in Your PC-AT | 3-5 |
| SECTION 4. RUNNING SETUP | 4-1 |
| 4.1 SETUP Examples | 4-5 |
| SECTION 5. INSTALLING RAMPAGE 286 SOFTWARE | 5-1 |
| 5.1 Example SuperPak Configuration | 5-3 |
| 5.2 Starting the INSTALL Program | 5-4 |
| 5.3 Installing Options | 5-8 |
| 5.4 Save the Installation | 5-9 |
| APPENDIX A. SWITCH SETTING SUMMARY | A-1 |
| A.1 Rampage 286 Conventional/Extended Memory Size | A-1 |
| A.2 Base I/O Address | A-4 |
| A.3 Dual Page Mode | A-6 |
| A.4 Conventional/Extended Memory Already Installed | A-7 |
| A.5 Parity Checking | A-10 |
| APPENDIX B. MEMORY ALLOCATION WITH DESQVIEW | B-1 |
| B.1 Best Rampage 286 Memory Allocation | B-1 |
| B.2 Allocating Add-on Board Memory | B-5 |
| B.3 Running SETUP | B-5 |

CONTENTS

| | |
|--|------|
| APPENDIX C. ADDING OR REMOVING MEMORY | C-1 |
| C.1 Memory Chip Specification | C-1 |
| C.2 Rules for Adding or Removing Memory | C-2 |
| APPENDIX D. ADVANCED INSTALL PROCEDURES | D-1 |
| D.1 Using INSTALL | D-3 |
| D.2 Running the INSTALL Program | D-5 |
| D.3 Installing SuperPak Software for Another PC-AT | D-6 |
| D.4 INSTALL Main Menu | D-8 |
| D.5 Installing fASTdisk | D-9 |
| D.6 Installing SuperDrive | D-12 |
| D.7 Installing the AST Expanded Memory Manager | D-15 |
| D.8 Installing SuperSpool | D-16 |
| D.9 Saving the Installation | D-18 |
| D.10 Example of Completed Installation | D-20 |
| APPENDIX E. HOW RAMPAGE 286 WORKS | E-1 |
| E.1 Memory Paging | E-1 |
| E.2 Expanded Memory Manager — REMM.SYS | E-4 |
| E.3 Extended Memory Emulator — REX.SYS | E-4 |
| E.4 Modifying REMM and REX | E-5 |
| E.4.1 DEVICE = REMM.SYS Parameters | E-6 |
| E.4.2 DEVICE = REX.SYS Parameters | E-9 |
| E.4.3 Modifying CONFIG.SYS for fASTdisk | E-12 |

CONTENTS

APPENDIX F. PRODUCT REPAIR PROCEDURE F-1

GLOSSARY G-1

Figures

Figure 1-1. Example Memory Map 1-7

Figure 2-1. Rampage 286 Board Layout 2-2

Figure 2-2. Rampage 286 Switch SW1
(Default Setting) 2-7

Figure 2-3. Rampage 286 Switch SW2
(Default Setting) 2-12

Figure 2-4. Setting for Conventional/Extended
Memory Already Installed for
Use with DESQview (256 KB) 2-13

Figure 3-1. Removing the Cover
(PC XT Model 286) 3-2

Figure 3-2. Removing the Cover (PC AT) 3-3

Figure 3-3. PC AT System Board Jumper 3-4

Figure 3-4. Installing the Rampage 286 Board 3-5

Figure 4-1. Initial INSTALL Screen 4-4

Figure 4-2. Main INSTALL Menu 4-4

Figure 5-1. Initial INSTALL Screen 5-5

Figure 5-2. Main INSTALL Menu 5-7

Figure A-1. Rampage 286 Conventional/Extended
Memory Size A-3

Figure A-2. Rampage 286 Base I/O Address
Settings A-5

Figure A-3. Dual Page Mode Configuration A-6

Figure A-4. Conventional/Extended Memory
Already Installed A-8

Figure A-5. Parity Error Checking A-10

CONTENTS

Figure B-1. Switch Settings for Best DESQview
Performance (PC XT Model 286) B-3

Figure B-2. Switch Setting for Best DESQview
Performance (PC AT) B-4

Figure C-1. Rampage 286 Memory Banks C-3

Figure D-1. Main INSTALL Menu D-8

Figure D-2. INSTALL with fASTdisk Edit Box D-11

Figure D-3. INSTALL with SuperDrive Edit Box 3-14

Figure D-4. INSTALL with SuperSpool Edit Box 3-17

Figure E-1. Paging Technique E-3

Tables

Table 2-1. Rampage 286 Default Configuration 2-3

Table 2-2. Rampage 286 Conventional/Extended
Memory Size 2-9

Table 2-3. Rampage 286 Base I/O Address 2-10

Rampage® 286 is a flexible and powerful memory enhancement board, which represents a new generation of products to expand the available memory for your Personal Computer XT (PC XT™) Model 286 or PC AT®. Rampage 286 offers:

- *Conventional memory.* Computer memory from 0 to 640 kilobytes (KB) is called conventional memory.

Your computer's system board contains a certain amount of conventional memory, and add-on boards (such as Rampage 286) can provide additional conventional memory. No matter how much memory you install in your computer, you can never have more than 640 KB of conventional memory. The IBM PC Disk Operating System (DOS) can directly use all the conventional memory installed in your computer.

- *Extended memory.* Memory in the 1- to 16-megabyte (MB) address range is called extended memory. (Extended and conventional memory are also called "linear" or "non paged" memory.)

Extended memory is used by the 80286 microprocessor (the "brains" of the PC AT or PC XT Model 286) when it operates in protected mode. (The *Technical Reference Manual* for your computer provides further information on protected mode.) AST®'s SuperPak™ random access memory (RAM) drive and print spooler software, IBM's VDISK, and the XENIX™ operating system use extended memory. However, current versions of DOS and most application programs cannot access extended memory directly.

- *Expanded memory.* Memory on your Rampage 286 board other than conventional or extended memory. Rampage 286 expanded memory supports expanded memory specification (EMS) software, including Lotus 1-2-3 Release 2™ and Symphony 1.1™. These applications use expanded memory by interfacing with AST's expanded memory manager software, which is supplied with your Rampage 286 board.

Rampage 286 also supports the enhanced expanded memory specification (EEMS), providing superior performance with software written to support it, including the DESQview™ multitasking/windowing environment.

AST expanded memory software allows your computer to access up to 8 MB of memory (using four 2-MB AST expanded memory boards, including Rampage 286 and Advantage Premium™), while maintaining DOS compatibility.

NOTE

To ensure compatibility, use only AST expanded memory products (such as Advantage Premium) in addition to Rampage 286.

- *Full compatibility with the Lotus/Intel/Microsoft (LIM) version 3.2 Expanded Memory Specification (EMS).* In addition, AST's EEMS offers a more flexible paging scheme that maximizes software performance and exceeds the capabilities of the LIM EMS.

1.1 Features

Rampage 286 hardware and software features are described in this section.

1.1.1 Hardware Features

The following hardware features are available:

- Up to 2 MB of expanded memory beyond the normal conventional memory limit of 640 KB. You can install as many as four Rampage 286 boards in a single PC XT Model 286 or PC AT, thus increasing the available memory by 8 MB. A typical maximum configuration might be 3 Rampage 286 boards (which provide 6 MB of memory) and an Advantage Premium with a Premium-Pak AT™ installed (which provides 2 MB of memory and I/O capabilities).
- Supports *conventional memory, expanded memory, and extended memory.* You can use up to 640 KB of Rampage 286 memory to round out conventional memory to its 640-KB limit, and allocate any part of Rampage 286 memory as extended memory — remaining memory is used as expanded (paged) memory.
- Rampage 286 can start at any memory address on a 128-KB boundary, from 0 to 16 MB (excluding the 640-KB to 1 MB range).
- Memory that is user-upgradeable in 512-KB increments, using 256-KB RAM chips.

NOTE

The RAM chips used with the Rampage 286 board must be 120-nanosecond access time or faster (such as 100-nanosecond).

These upgrade options are available for your Rampage 286:

- Memory expansion is available in 512-KB increments up to 2048 KB (2 MB) on the Rampage 286 board. You can upgrade Rampage 286 memory with an AST upgrade kit (part number MPAD-512/120).

1.1.2 Software Features

Rampage 286 software offers the following features:

- Full compatibility with the Lotus/Intel/Microsoft (LIM) version 3.2 Expanded Memory Specification (EMS). Rampage 286 is fully compatible with LIM EMS software.
- AST's enhanced EMS (EEMS) exceeds the LIM EMS and is a superset of that standard. EEMS's more flexible paging scheme allows maximum software performance, including fast access to multiple programs and multitasking under DESQview. (Appendix E describes EEMS's paging scheme.)
- The Rampage expanded memory manager (REMM) software driver, which works with EEMS software such as the DESQview operating environment to provide expanded memory for data and programs. REMM also works with EMS software such as Lotus 1-2-3 Release 2 to provide expanded memory for data.
- The Rampage extended memory emulator (REX) module, which allows Rampage 286 expanded memory to emulate extended memory. This allows you to dynamically reconfigure Rampage 286 *expanded memory* as extended memory without having to remove the board and reset its switches.
- SuperPak RAM disk and print spooler software, including the following programs:
 - *fASTdisk*[™], a program that simulates fixed disks in RAM. A *fASTdisk* can be as large as total computer memory, and allows you to store and retrieve data and programs at RAM speeds.
 - *SuperDrive*[™], a floppy disk emulation program that allows you to use part of your memory as a superfast "electronic disk drive".

- *SuperSpool*[™], an intelligent print spooler that allows you to output files to a printer while freeing your computer for other tasks.
- *INSTALL*, a software installation utility that allows easy installation of the *fASTdisk*, *SuperDrive*, *SuperSpool*, and Rampage programs.

NOTE

You must use a version 6.10 (or later) SuperPak diskette with Rampage 286 in order to have the correct REMM and INSTALL programs. All your SuperPak software is fully downward-compatible, and can be used in place of any earlier SuperPak software you are now using with other AST products.

1.2 Example Memory Allocation

A typical example of how Rampage 286 memory can be allocated is presented in this section. Suppose your computer has 512 KB of conventional memory installed and your Rampage 286 provides 2 MB of RAM. You would like to use Rampage 286 to accomplish the following:

- Fill out conventional memory to 640 KB.
- Allocate extended memory to create a 384-KB *fASTdisk*.
- Use all remaining Rampage 286 memory as expanded memory for use with application programs running under DESQview multitasking/windowing software. (See Appendix B for best memory allocation with DESQview.)

You would set Rampage 286 for 512 KB of conventional/extended memory already installed in your computer, and allocate 512 KB of Rampage 286 memory as conventional/extended memory, — 128 KB are used to round out conventional memory, and 384 KB as extended memory. The remaining 1536 KB (1.5 MB) of Rampage 286 memory would then be used as expanded memory. Figure 1-1 shows the memory map for this example application.

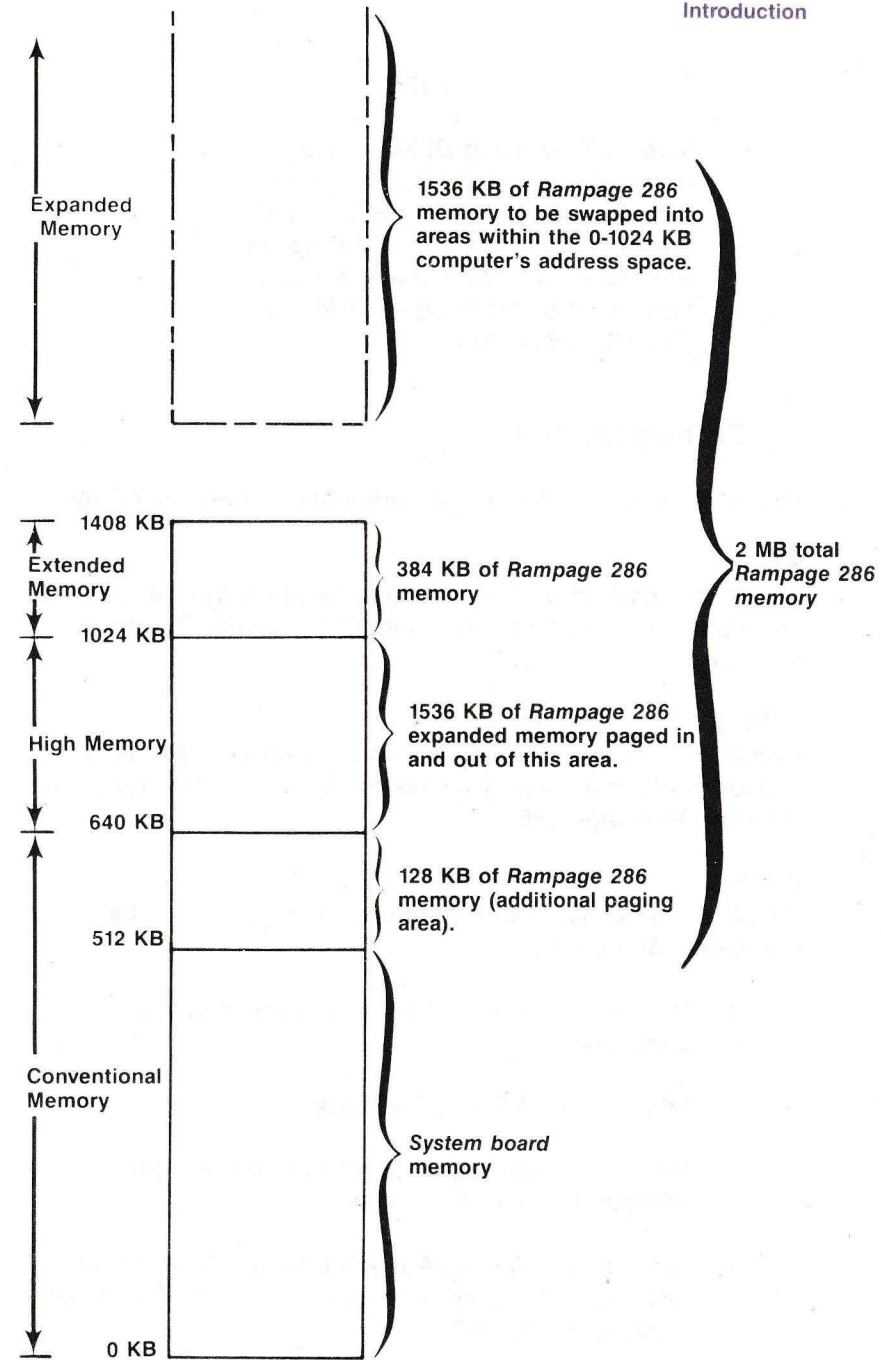

Figure 1-1. Example Memory Map.

NOTE

If you will be using DESQview with Rampage 286, you can change the default configuration of the board for optimum operation with that program. Appendix B of this manual tells you how to set up Rampage 286 for best use with DESQview.

1.3 Getting Started

This section tells you how to get started with your Rampage 286.

STEP 1

Check the contents of your Rampage 286 package. Section 1.4 provides a checklist of what should be included with your package.

STEP 2

Review the system requirements for Rampage 286. Read Section 1.5 to make sure your system meets the requirements for using Rampage 286.

STEP 3

Decide on the configuration you need. How you configure Rampage 286 depends on:

- How much memory is already installed in your computer.
- Whether you will use DESQview.
- How much Rampage 286 memory you want to allocate as *expanded memory*.
- Whether you have an AST Advantage™, RAMvantage™, Advantage Premium, or another Rampage 286 board installed in your PC.

Section 2 provides further help in determining how to configure your Rampage 286 board.

STEP 4

Configure Rampage 286. Based on the requirements you determined in STEP 3, set the switches on your Rampage 286 board. You can use the configuration set at the factory (the *default configuration*) if:

- You are installing Rampage 286 in a PC XT Model 286 or PC AT that already has exactly 512 kilobytes (KB) of conventional memory installed.
- No other expanded memory board is installed in your system.

If the default configuration doesn't meet your needs, you must reconfigure the board. The Rampage 286 has two switch blocks on it, SW1 and SW2. Each switch block has several switches on it that can be set to either ON or OFF. Section 2 provides further details on configuring SW1 and SW2.

STEP 5

Configure the PC AT system board. If you are installing Rampage 286 in a PC AT, check the position of a jumper on the system board. This jumper determines how much system board memory the PC AT will recognize. Section 3.1 tells you how to check the position of the PC AT system board jumper.

A *jumper block* is a set of bare pins. You can connect two adjacent pins by installing a jumper across them. A *jumper* is just a little piece of metal that connects two pins, and is usually encased in plastic.

STEP 6

Install Rampage 286. Once the Rampage 286 board is configured, you must install it in your PC. Follow the instructions in Section 3.

STEP 7

Run the *SETUP* program. Whenever you change your memory configuration, and you plan to add a SuperDrive RAM diskette drive, you need to run the IBM *SETUP* program provided with your computer. Section 4 gives examples of what parameters you should supply while you are running *SETUP*.

STEP 8

Install the software that comes with *Rampage 286*. Section 5 tells you how to use AST's *INSTALL* program to configure and install the *Rampage 286* software.

STEP 9

Start your application software package. Choose EEMS- or EMS-compatible application software. See the instructions that came with your software.

1.4 Checklist

Before you get started, check that your *Rampage 286* package includes the following items:

- *Rampage 286* full-size expanded memory board.
- SuperPak diskette (version 6.10 or later).
- *Rampage 286 User's Manual* (000432-001).
- *SuperPak User's Manual* (000300-001).

1.5 System Requirements

The minimum hardware requirements using *Rampage 286* are an IBM PC XT Model 286 or PC AT (or compatible) with one floppy diskette drive and an unused two-connector expansion slot.

Rampage 286 software is compatible with DOS 2.0 or later or an MS-DOS equivalent. (The PC AT uses DOS 3.0 or later, and the PC XT Model 286 uses DOS 3.2 or later.)

1.6 How To Use This Manual

This section provides an outline of the format notation used throughout the manual, a list of related documentation, and an outline of the manual.

1.6.1 Format Notation

The following format notation is used in this manual:

- *Boldface* is used to indicate keyboard entries the user must make.
- *Uppercase characters* indicate items (such as commands) that you enter exactly as shown. However, you can enter those items in any combination of upper- or lowercase letters.
- *Lowercase letters* represent parameters that are defined by the user. While the user defines the parameters, they must satisfy the conditions of the command description.
- *Angle brackets* (< >) tell you to press a key. For example, <Esc> instructs you to press the "Esc" key. You do not have to press <Enter> unless you are specifically instructed to do so.
- *Square brackets* ([]) indicate an optional term which is included or omitted at your discretion. The brackets are not entered.
- System prompts and messages are indicated in color.
- *Hexadecimal numbers* are indicated with a leading zero (0) and a trailing lowercase "h" (for example, 0208h).

1.6.2 Related Documentation

This manual assumes some familiarity with the PC-DOS operating system and the IBM PC AT or PC XT Model 286 hardware. You may find it useful to have available the following documents for reference:

- *Guide to Operations.*
- *Technical Reference Manual.*
- *Disk Operating System (DOS) Manual.*
- *Installation and Setup (for the PC AT).*
- *SuperPak User's Manual.*
- *Specification for an Expanded Memory Device Interface Product, Copyright © 1985 AST Research, 2121 Alton Avenue, Irvine, CA 92714.*
- *Enhanced Expanded Memory Specification (Enhanced EMS) Software Interface, Copyright © 1986 AST Research, 2121 Alton Avenue, Irvine, CA 92714.*
- *The Lotus®/Intel®/Microsoft® Expanded Memory Specification for Hardware Vendors, Copyright © 1985 Lotus Development Corporation, 55 Cambridge Avenue Cambridge, MA 02142.*

1.6.3 Manual Outline

SECTION 1: INTRODUCTION

Describes the features of the Rampage 286 product, and provides an overview on getting started, information on system requirements, format notation, and related documentation.

SECTION 2: CONFIGURING YOUR RAMPAGE 286 BOARD

Provides a quick reference guide to the most common settings for Rampage 286 and (for the PC AT) the system board. Includes a step-by-step guide through every switch setting.

SECTION 3: INSTALLING RAMPAGE 286 IN YOUR PC-AT

Tells you how to install your Rampage 286 board in your computer.

SECTION 4: RUNNING SETUP

Gives several examples of how to run the SETUP program when you install Rampage 286 in your computer.

SECTION 5: INSTALLING SUPERPAK SOFTWARE

Gives a basic procedure for installing a typical software configuration on your boot disk that allows programs to use expanded memory.

APPENDIX A: SWITCH SETTING SUMMARY

A detailed summary of all Rampage 286 switch settings. Unless you have a particular reason to change the board configuration, you should not need the information in this appendix.

APPENDIX B: MEMORY ALLOCATION WITH DESQVIEW

Gives suggestions on how to allocate your Rampage 286 memory to provide the best DESQview performance.

APPENDIX C: ADDING OR REMOVING MEMORY

Tells you how to add or remove Rampage 286 memory. You don't need to read this section unless you are changing the amount of memory installed on Rampage 286.

APPENDIX D: ADVANCED INSTALL PROCEDURES

Provides further details about using the INSTALL program to place SuperPak and expanded memory software on your boot disk. Describes how to modify the parameters for each program.

APPENDIX E: HOW RAMPAGE 286 WORKS

Gives a brief overview of how Rampage 286 works, including the concept of memory paging, descriptions of the REMM and REX software modules, and how to modify them.

APPENDIX F: PRODUCT REPAIR PROCEDURE

Provides instructions for obtaining repair service on your AST Research product.

GLOSSARY

Defines several technical terms that appear in this manual.

CONFIGURING YOUR RAMPAGE 286 BOARD

This section gives a step-by-step procedure for configuring the Rampage 286 board. It provides the information you need to configure your board in most circumstances. Appendix B suggests appropriate switch settings for use with DESQview multitasking/windowing software.

Section 2.1 shows the Rampage 286 default configuration (how the board is configured at the factory). If the default configuration meets your needs, you can skip directly to Section 3.

If you need to change any of the settings, Section 2.2 leads you step-by-step through each switch and jumper setting.

2.1 Default Configuration

This section provides a quick reference guide to the default settings for the Rampage 286 board (shown in Figure 2-1).

If the default settings are appropriate for your system, you can skip directly to Section 3, with no further configuration. The default settings are appropriate if:

- You are installing Rampage 286 in a PC AT or PC XT Model 286 that already has exactly 512 kilobytes (KB) of conventional memory installed.
- You install Rampage 286 in its default configuration (summarized in Table 2-1).
- You will not be using DESQview.

For a step-by-step guide to changing any of the parameters shown in Table 2-1, see Section 2.2.

Rampage 286 conventional/extended memory size 128 KB (SW1-1 through SW1-4). Base I/O address 0218h (SW1-5 through SW1-8). Dual Page Mode (SW1-9 ON). SW1-10 not used.

512 KB conventional/extended memory installed in PC (SW2-1 through SW2-7). Parity checking enabled (SW2-8 ON).

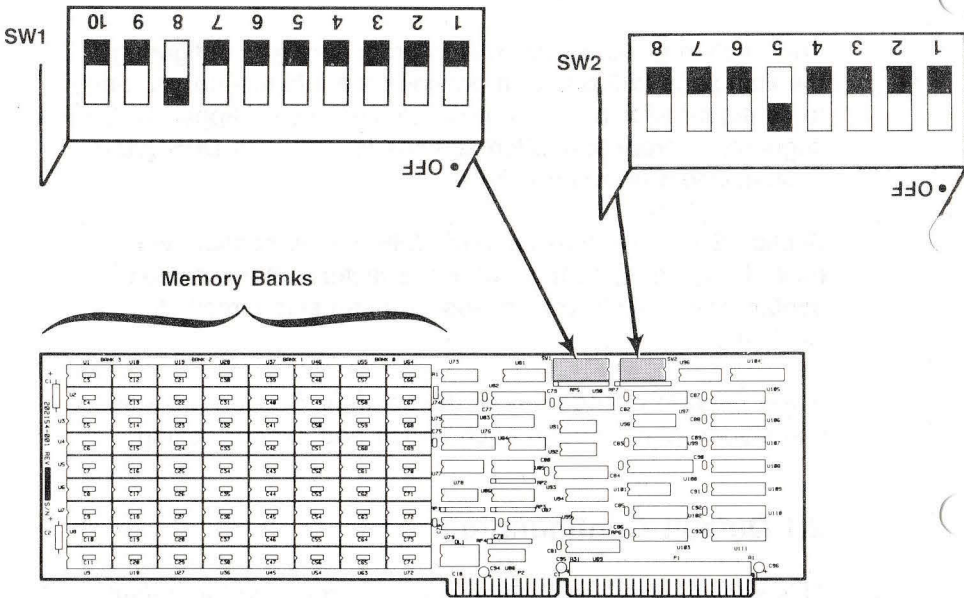

Figure 2-1. Rampage 286 Board Layout.

Table 2-1. Rampage 286 Default Configuration.

| Parameter | Default | Comments |
|---|--|---|
| <i>Expanded Memory Parameters</i> | | |
| Rampage 286 conventional/extended memory size | 128 KB (SW1-1 ON SW1-2 ON SW1-3 ON SW1-4 ON) | The amount of Rampage 286 memory that can be allocated as conventional or extended memory. Remaining Rampage 286 memory is used as expanded memory. |
| Base I/O address | 0218h (SW1-5 ON SW1-6 ON SW1-7 ON SW1-8 OFF) | Rampage 286 uses the I/O address to communicate with the computer, allowing it to use expanded memory. Do <i>not</i> change this parameter unless you are installing more than one Rampage 286 board in your system, or another device (such as an Advantage Premium) in your PC uses the same I/O address range. |
| Dual Page mode | Enabled (SW1-9 ON) | Ensures proper multitasking operation (allows two sets of Mapping registers to be used). DESQview requires Dual Page mode enabled. |
| <i>Conventional/Extended Memory Configuration</i> | | |
| Conventional/extended memory already installed | 512 KB (SW2-1 ON SW2-2 ON SW2-3 ON SW2-4 ON SW2-5 OFF SW2-6 ON SW2-7 ON) | Change this setting if your computer has other than 512 KB of conventional memory already installed or if you want to address additional Rampage 286 memory below 640 KB to enhance multitasking with DESQview. (See NOTE). |
| NOTE | | |
| Appendix B tells you how to set up your Rampage 286 and PC for use with DESQview. | | |
| Parity checking | Enabled (SW2-8 ON) | Parity checking enables memory error checking. To ensure reliability, do not disable. |

2.2 Basic Configuration

This section tells you what you need to know before you configure Rampage 286, then guides you step-by-step through each switch setting on the board.

2.2.1 What You Need to Know Before You Start

Before you change the configuration of your Rampage 286 board, you need to answer the following questions.

A. Are there any other expanded memory boards installed in your computer?

If your computer includes any other AST expanded memory boards (for example, AST's Advantage Premium board), you will need to make sure that Rampage 286 and the other board(s) are configured to avoid base I/O address and memory address conflicts with each other. Use *only* AST expanded memory boards together with Rampage 286 in the same machine.

B. Do you want to use DESQview?

If so, you will want to set up your computer and Rampage 286 board memory for best performance with DESQview. See Appendix B for information on using DESQview.

C. How much conventional/extended memory is already installed in your computer?

One of the Rampage 286 switch settings is the total amount of conventional *and* extended memory already installed in your computer. Memory between 0 and 640 KB is called *conventional* memory. Memory in the range from 1 megabyte (MB) to 16 MB is called *extended* memory. (The range from 640 KB to 1 MB is called high memory. Portions of memory in this range are reserved for video display buffer memory and other DOS housekeeping functions.)

If you are not sure how much conventional/extended memory is installed in your computer, you can quickly check it by rebooting the PC and watching the memory total in the upper lefthand corner of the screen. As the computer checks its memory, the total increases. The final amount shown is your total conventional and extended (linear) memory. The total shown includes any add-on memory (such as *Advantage!* memory) that has been added to your system.

You will need to separate total linear memory out into total conventional and total extended memory when you run the SETUP program after your Rampage 286 is installed. To do this, you should subtract 640 KB from your total linear memory. Any remainder is extended memory. If your total linear memory is less than 640 KB, then it is all conventional memory. This is because you must have a full 640 KB of conventional memory (the maximum possible conventional memory) installed before you can allocate any memory as extended memory.

NOTE

If you will be using DESQview, you may need to change your current memory configuration. See Appendix B for further information.

D. How much Rampage 286 memory do you want to allocate as conventional memory?

If your computer has less than 640 KB of conventional memory installed, you will probably want to allocate enough Rampage 286 memory to round out your conventional memory to 640 KB.

To determine how much Rampage 286 memory to allocate as conventional memory, note the amount of memory displayed at boot-up time (see question C). If more than 640 KB is displayed, then you already have a full 640 KB of conventional memory.)

If you plan to use DESQview, you should allocate as much Rampage 286 memory as possible as conventional memory (see Appendix B).

E. How much Rampage 286 memory do you want to allocate as extended memory

Extended memory is a special type of memory available only on the PC XT Model 286 and the PC AT. Most application programs are not able to use extended memory. Unless you will be running the IBM VDISK program or the XENIX operating system, you probably do not want to add extended memory to your system by setting Rampage 286 hardware switches.

If you want to use extended memory only for RAM disks (AST's SuperDrive and fASTdisk) or AST's SuperSpool print spooler program, the SuperPak INSTALL program will automatically allocate Rampage 286 expanded memory as *emulated* extended memory. That way, you need not worry about setting your Rampage 286 hardware switches to allocate Rampage 286 memory as extended memory.

F. How much Rampage 286 memory do you want to allocate as conventional/extended memory?

Add your totals from D and E together to get the total Rampage 286 memory that you want to allocate as conventional *and* extended memory. One of your Rampage 286 switch settings is set according to this total. (See Appendix B for best settings with DESQview.)

The following sections take you step-by-step through the configuration of the two switches on your Rampage 286 board.

2.2.2 SW1 Location and Default Settings

Figure 2-2 shows the location and default setting for SW1.

This switch block is shown in the wrong orientation. Has been corrected in the replacement page 2-7, located in the addendum at the rear.

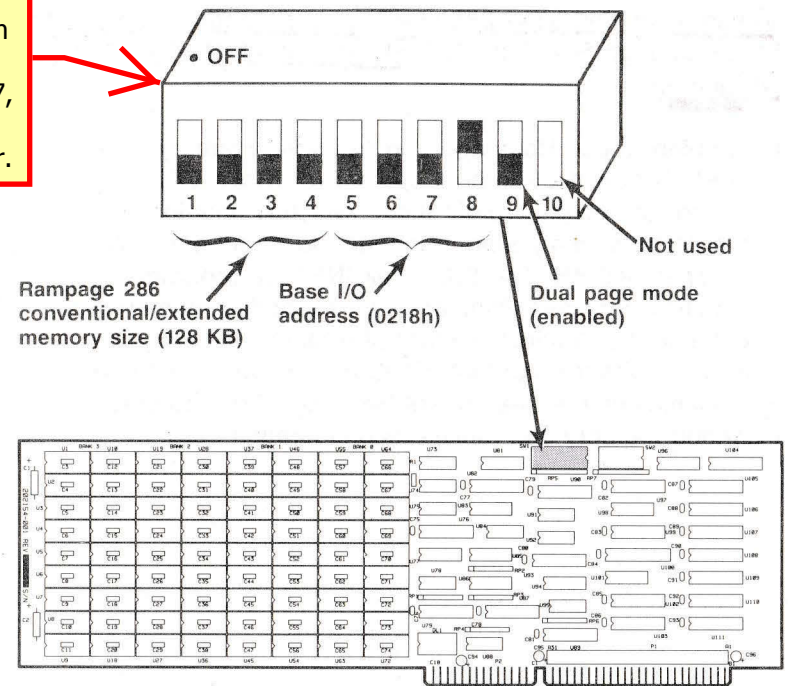

Figure 2-2. Rampage 286 Switch SW1 (Default Setting).

2.2.3 Conventional/Extended Memory Size Setting (SW1-1 through SW1-4)

The amount of Rampage 286 memory used as conventional/extended memory is determined by switches SW1-1 through SW1-4. The default position for these switches sets Rampage 286 conventional/extended memory size to 128 KB. Leave switches SW1-1 through SW1-4 in their default settings if your computer has 512 KB of system memory installed and you want to fill out conventional memory to 640 KB.

If you do not want to use the default setting, then set switches SW1-1 through SW1-4 as shown in Table 2-2.

To use all of Rampage 286 memory as expanded memory, set SW2-1 through SW2-7 to OFF. SW1-1 through SW1-4 will then be ignored.

If you plan to use Rampage 286 extended memory only for AST RAM disks and print spooler (or IBM's VDISK), the simplest option is to set these switches only for the *conventional memory* amount needed to round out system memory to 640 KB. The SuperPak INSTALL program automatically causes Rampage 286 expanded memory to emulate the required amount of *extended* memory by placing a software program (REX.SYS) on your boot disk. This eliminates the need to set Rampage 286 switches for extended memory and makes reconfiguration easy.

Table 2-2. Rampage 286 Conventional/Extended Memory Size.

| Rampage 286 Conventional/Extended Memory Size * | SW1-1 | SW1-2 | SW1-3 | SW1-4 |
|---|-------|-------|-------|-------|
| ** 128 KB | ON | ON | ON | ON |
| 256 KB | ON | ON | ON | OFF |
| 384 KB | ON | ON | OFF | ON |
| 512 KB | ON | ON | OFF | OFF |
| 640 KB | ON | OFF | ON | ON |
| 768 KB | ON | OFF | ON | OFF |
| 896 KB | ON | OFF | OFF | ON |
| 1024 KB | ON | OFF | OFF | OFF |
| 1152 KB | OFF | ON | ON | ON |
| 1280 KB | OFF | ON | ON | OFF |
| 1408 KB | OFF | ON | OFF | ON |
| 1536 KB | OFF | ON | OFF | OFF |
| 1664 KB | OFF | OFF | ON | ON |
| 1792 KB | OFF | OFF | ON | OFF |
| 1920 KB | OFF | OFF | OFF | ON |
| 2048 KB | OFF | OFF | OFF | OFF |

* These settings are ignored if all Rampage 286 memory is to be used as expanded memory (SW2-1 through SW2-7 OFF).

** Default setting.

This switch block is shown in the wrong orientation. Has been corrected in the replacement page 2-9, located in the addendum at the rear.

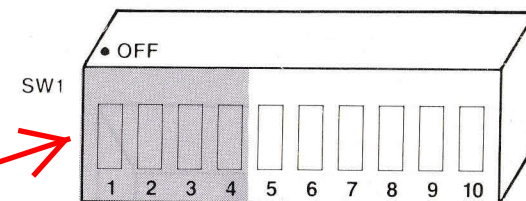

2.2.4 Base I/O Address Settings (SW1-5 through SW1-8)

The base I/O address is determined by switches SW1-5 through SW1-8. The default position for these switches sets the Rampage 286 base I/O address to 0218h. Leave SW1-5 through SW1-8 in the default positions unless you have another *expanded memory* board in your computer with base I/O address 0218h, or another device that uses the base I/O address 0218h or any address that belongs to the same group with base I/O address 0218h. (The group of addresses is provided in the note given below.)

If you have another expanded memory board in your computer (such as another Rampage 286 or an Advantage Premium), or another device with a conflicting I/O address, configure Rampage 286 to use a different base I/O address. (Table 2-3 summarizes the possible base I/O addresses).

Table 2-3. Rampage 286 Base I/O Address.

| Base I/O Address | Rampage 286 Switch Settings | | | |
|-------------------|-----------------------------|-------|-------|-------|
| | SW1-5 | SW1-6 | SW1-7 | SW1-8 |
| 0208h | ON | ON | ON | ON |
| * 0218h | ON | ON | ON | OFF |
| 0258h | ON | OFF | ON | OFF |
| 0268h | ON | OFF | OFF | ON |
| 02A8h | OFF | ON | OFF | ON |
| 02B8h | OFF | ON | OFF | OFF |
| 02E8h | OFF | OFF | OFF | ON |
| * Default setting | | | | |

NOTE

When you select base I/O address 02x8h, Rampage 286 uses these addresses:

02x8h, 42x8h, 82x8h, C2x8h,
02x9h, 42x9h, 82x9h, C2x9h

For example, selecting base I/O address 0208h causes the Rampage 286 board to use I/O addresses 0208h, 4208h, 8208h, C208h, 0209h, 4209h, 8209h, and C209h.

2.2.5 Dual Page Mode (SW1-9)

Switch position SW1-9 enables or disables dual page mode. Dual Page mode is enabled by default on your Rampage 286. Dual Page mode allows Rampage 286 to handle multitasking — handling several jobs at once — efficiently, as when you use the DESQview program. Dual Page mode should be left enabled.

NOTE

Switch SW1-10 is not used. It can be left ON or OFF.

2.2.6 SW2 Location and Default Settings

Figure 2-4 shows the location and default setting for SW2.

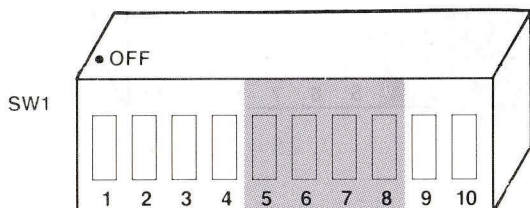

This switch block is shown in the wrong orientation. Has been corrected in the replacement page 2-10, located in the addendum at the rear.

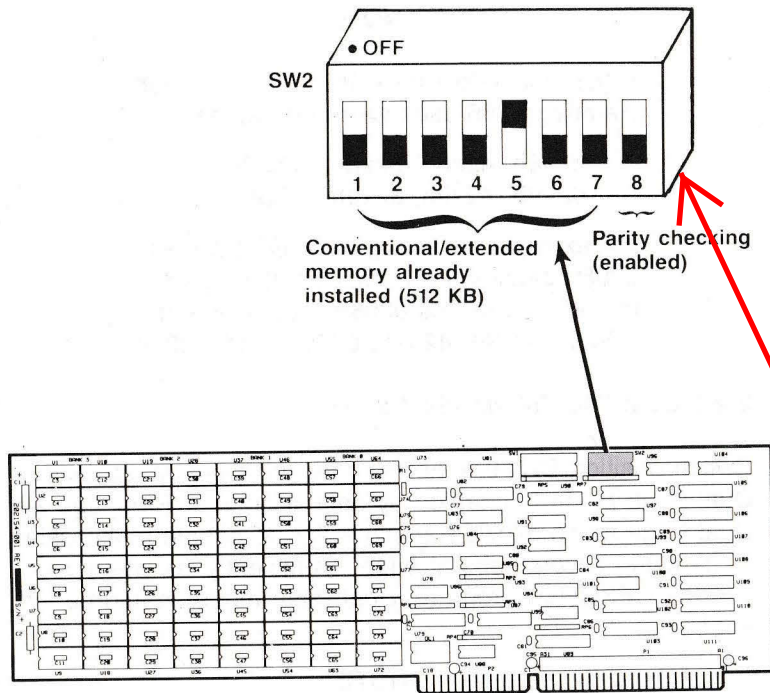

Figure 2-3. Rampage 286 Switch SW2 (Default Setting).

2.2.7 Conventional/Extended Memory Installed (SW2-1 through SW2-7)

The amount of conventional/extended memory already installed in your computer before adding Rampage 286 determines how you should set switch positions SW2-1 through SW2-7.

Leave switches SW2-1 through SW2-7 in their default setting if your PC-AT has 512 KB already installed *and* you do not plan to use DESQview.

To use all of Rampage 286 memory as expanded memory, set SW2-1 through SW2-7 to OFF.

If you plan to use DESQview, and your Rampage 286 board has enough memory installed, it is a good idea to change the switch setting as shown in Figure 2-5. The more Rampage 286 memory that is allocated in the area from 0-640 KB, the greater the enhancement of DESQview's performance. See Appendix B for more information on memory allocation with DESQview.

Appendix A gives all the switch settings for this parameter.

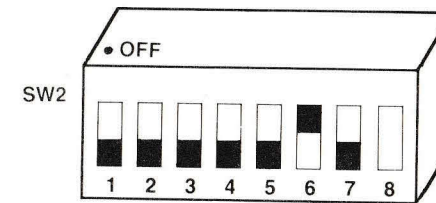

This switch block is shown in the wrong orientation.

Figure 2-4. Setting for Conventional/Extended Memory Already Installed for Use with DESQview (256 KB).

2.2.8 Parity Checking (SW2-8)

Switch position SW2-8 enables or disables parity checking. By default, SW2-8 is ON, enabling parity checking. Leave SW2-8 ON unless you have a special reason to disable parity checking. Only under rare circumstances would you change this setting.

This switch block is shown in the wrong orientation. Has been corrected in the replacement page 2-12, located in the addendum at the rear.

Notes

INSTALLING RAMPAGE 286 IN YOUR COMPUTER

3

This section provides installation instructions, including:

- Preparing your computer for installing Rampage 286 (Section 3.1).
- Installing the board in your computer (Section 3.2).

3.1 Opening Your Computer

This section tells you how to set up your computer before installing Rampage 286.

CAUTION

Be sure that the power switch is off and the power cord is removed from the wall outlet. Turn off any other equipment connected to the computer. Installing any component while the power is on can permanently damage your computer and its components.

You will need a flathead screwdriver or nut driver to perform the following procedure.

STEP 1

Remove the cover.

For the PC XT Model 286: Use a flathead screwdriver or nut driver to remove the cover mounting screws from the rear panel of the computer. Once you have removed the cover mounting screws, pull the cover off as shown in Figure 3-1.

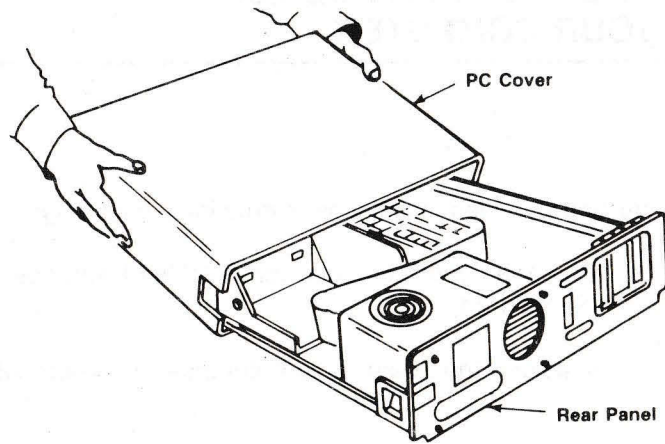

Figure 3-1. Removing the Cover (PC XT Model 286).

For the PC AT: Unlock the key lock at the front of the PC AT by turning the key counterclockwise. Remove the back panel (which is attached with plastic fastener strips) from the rear of the computer. Use a flathead screwdriver or nut driver to remove the cover mounting screws. Slide the cover toward the front until it comes off, as shown in Figure 3-2.

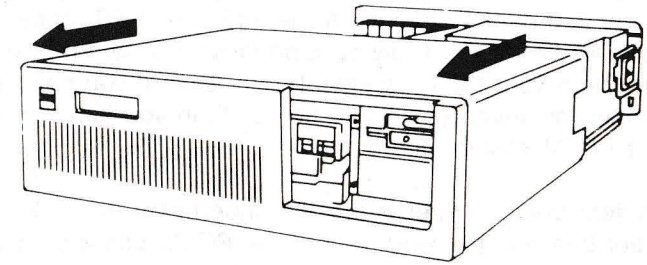

Figure 3-2. Removing the Cover (PC AT).

STEP 2

Check system board configuration.

For the PC XT Model 286: You need only note how much memory is installed on the system board (either 512 or 640 kilobytes — KB). If you are unsure how much system board memory is in your computer, ask your dealer.

For the PC AT: The system board jumper J18 (shown in Figure 3-3) determines the maximum amount of system board memory the PC AT will recognize (regardless of how much system board memory is actually installed). In the 256-KB position, the system board recognizes a maximum of 256 KB. In the 512-KB position, the system board recognizes a maximum of 512 KB. Do *not* set the jumper in the 512-KB position when only 256 KB of memory is installed on the system board.

Set the jumper in the 256-KB position if you will be using Rampage 286 paged memory in the 256-to 640-KB range (for example, for best DESQview performance). Do *not* remove memory from your PC AT system board, even if you have set the jumper for memory installed to less than you actually have on your PC AT system board.

The system board jumper is located underneath the disk controller board at the very front of the PC AT chassis. You will have to lift the disk controller board to access the jumper. To do this, remove the disk controller board's bracket retaining screw and *carefully* lift the board about two inches. Take care not to put too much stress on the ribbon cables attached to the board. Once you've configured the jumper correctly, reinstall the disk controller board.

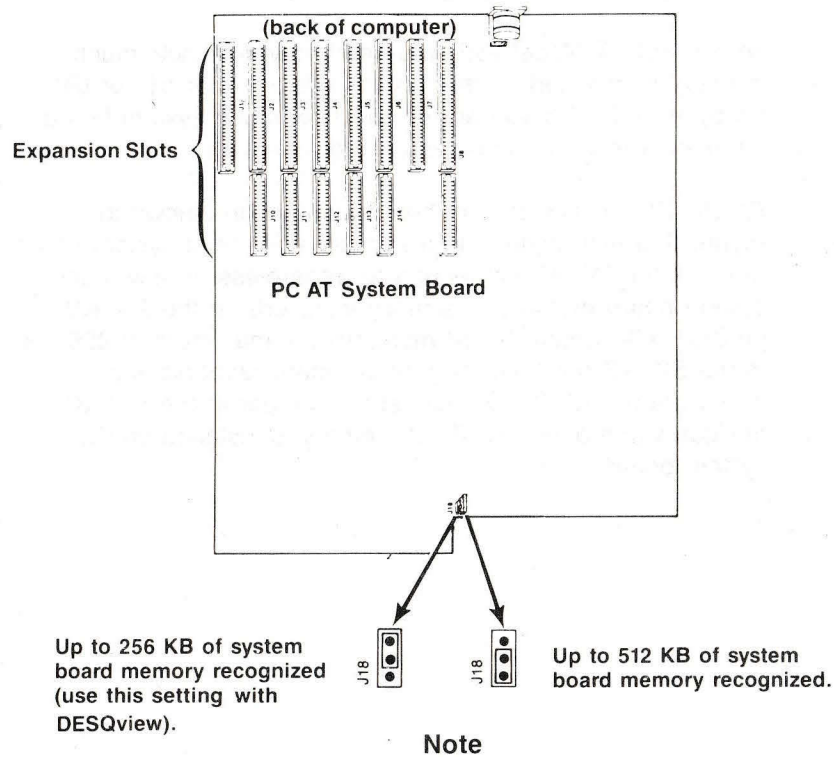

You must lift the disk controller board to access this jumper.

Do not remove memory from the system board regardless of the jumper setting.

3.2 Installing Rampage 286 in Your Computer

This section tells you how to install the Rampage 286 board into your computer.

STEP 1

Select an open expansion slot: Rampage 286 requires one two-connector slot.

STEP 2

Remove expansion slot cover: Locate the metal cover for the cutout in the back panel of the chassis for the slot that you have selected. Remove and save the bracket retaining screw using a small flathead screwdriver. Remove the expansion slot cover.

STEP 3

Install the Rampage 286 board: Line up your Rampage 286 board and position its front bottom corner in the card guide channel. Position any wires or ribbon cables so they will pass either beneath or above the installed board and will not be damaged during installation. Lower the board until its edge connector rest on the expansion slot receptacle. Using an evenly distributed pressure, press the Rampage 286 board straight down until it seats in the expansion slot (Figure 3-4).

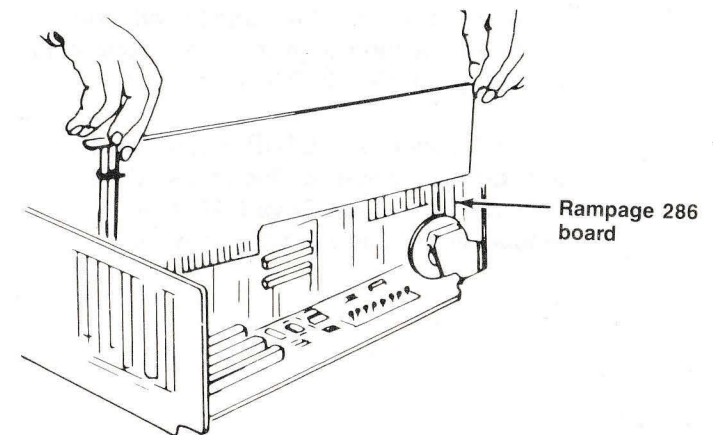

Figure 3-4. Installing the Rampage 286 Board.

STEP 4

Secure the board to the rear of the chassis: Use the screw you removed from the expansion slot cover in STEP 2.

STEP 5

Replace cover: Carefully slide the cover from the front until it stops securely against the rear panel. Reinstall the cover mounting screws you removed earlier.

For the PC AT: Press the back panel so that the plastic fastener strips secure it in place.

STEP 6

Install cables: Replace the power cord to the system unit and be sure that the keyboard and the monitor connectors are plugged in. Reattach any other cables and connectors you removed previously.

STEP 7

Now you are ready to power up.

NOTE

You must run the SETUP program whenever you add or subtract conventional or extended memory from your PC XT Model 286 or PC AT. The SETUP program is included on the diagnostics diskette that comes with your computer. Section 5 gives several examples of how to run the SETUP program.

You must also run SETUP if you plan to change the number of floppy disk drives (including the SuperDrive RAM disk emulation program) in your computer.

RUNNING SETUP

4

You must run the SETUP program (included on the diagnostics diskette that comes with your computer) whenever you add or subtract conventional and/or extended memory (also called *linear* or *non paged* memory) from your PC XT Model 286 or PC AT. This appendix provides several examples of how to run the SETUP program when you install Rampage 286 in your computer.

NOTE

You will also need to run SETUP to change the number of floppy disk drives to include a SuperDrive if you plan to create a SuperDrive with the INSTALL program.

To run the SETUP program, follow this procedure (specific examples follow):

STEP 1

Reboot: Insert the diagnostics diskette in drive A:. Press <Ctrl>-<Alt>- to reboot your computer. Unless your SETUP program happens to be configured for the new amount of memory in your computer, the screen will display a message similar to this:

xxxxx KB OK

yyy-Memory Size Error-(Run SETUP)

Press F1 to resume

where: xxxxx is the amount of conventional/extended memory installed in the PC. yyy is an error code.

STEP 2

Enter SETUP: Press <F1> to continue. Select the SETUP program from the SETUP menu. Follow the instructions on the screen. SETUP will present a list of the current configuration options, including diskette drives and memory configuration. At the bottom of the list is the following prompt:

Are these options correct (Y/N)
?

Press **N**.

SETUP will ask you to specify the disk drive and display adapter types for your computer — if you will be installing a SuperDrive using the INSTALL program, go to STEP 3. Otherwise, do not change those parameters, and go to STEP 4.

STEP 3

Define your floppy diskette configuration: This step is only necessary if you will be creating a SuperDrive with the INSTALL program. Your screen will display a message similar to the following:

Your diskette drive types are set to the following:

Diskette Drive A — High Capacity(1.2MB)
Diskette Drive B — Double Sided(360 KB)

Are diskette drive types correct (Y/N)
?

The exact configuration on your screen may be different from the example shown here. However, unless the configuration shown already includes a 360-KB double-sided drive with the drive letter you would like to use for your SuperDrive, answer **N**.

You will then be presented with a series of questions that will allow you to configure your system for a diskette drive that is double sided with a 360-KB capacity, the correct configuration for a SuperDrive. Your SuperDrive must be either drive A: or B:.

SETUP will then ask you to specify the adapter type for your computer. Do not change this parameter unless you have changed your computer's adapter or monitor configuration.

STEP 4

Enter the amount of base memory: When your screen displays:

- 256KB on the system board or,
- 512KB on the system board or,
- 640KB of Base memory consisting of 512KB on the system board, and 128KB on the 128KB Memory Expansion Option.

Base memory size is xxxKB

Is this correct(Y/N)
?_

where xxx is the total amount of base (conventional) memory installed in your computer.

Base memory includes any Rampage 286 memory you decide to allocate as conventional memory. If the amount shown is correct, press **Y**.

If the amount shown is not correct press **N**. Your screen will then display:

Enter correct Base Memory size
(256, 512, or 640).

?_

Enter the correct amount of conventional (base) memory.

Press <Enter> to proceed with the program.

STEP 5

Enter the amount of 'expansion' memory: Your screen will display:

The Expansion Memory size is composed of additional memory adapters not including the 128KB Memory Expansion option.

Expansion memory size is xxxxxKB

Is this correct(Y/N)
?__

SETUP calls the memory installed above 1 megabyte (MB) "expansion" memory. This manual calls memory above 1 MB "extended" memory. Do not include AST expanded memory in this total. Press **Y** if the amount shown is correct.

Press **N** if the amount shown is not correct. Your screen will then display:

| EXPANSION MEMORY SIZE |
|-----------------------|
| 0 |
| 512 |
| 1024 |
| 1536 |
| 2048 |
| |

Enter correct Expansion Memory size
(0, 512, 1024, 1536. . .).

?__

Enter the amount of memory installed above 1 MB (the amount does not necessarily have to be expressed in 512-KB increments, as implied in the display above). Press **<Enter>** to proceed with SETUP.

STEP 6

Verify that all *SETUP* options are set correctly: SETUP will then display the options for disk type, memory size, and adapter type. If all options are correct, press **Y** to reboot.

4.1 SETUP Examples

This section gives several sample Rampage 286 configurations and provides the appropriate SETUP parameters.

Example 1: Your PC AT has 256 KB of conventional memory installed, and you have a 512-KB Rampage 286 board. You want to use 384 KB of Rampage 286 memory to fill out conventional memory to 640 KB, and you want to allocate 128 KB as extended memory (memory addressed above 1 MB). Specify:

Base memory size: 640
Expansion memory size: 128

Example 2: Your PC XT Model 286 has 512 KB of conventional memory installed, and you have a 512-KB Rampage 286 board. You want to use 128 KB of Rampage 286 memory to fill out conventional memory to 640 KB, and you want to allocate 384 KB as extended memory. Specify:

Base memory size: 640
Expansion memory size: 384

Example 3: Your PC XT Model 286 has 512 KB of conventional memory installed, and you have a 2-MB Rampage 286 board. You want to use 128 KB of Rampage 286 memory to fill out conventional memory to 640 KB, and you want to allocate all remaining memory (1920 KB) as expanded memory. Specify:

Base memory size: 640
Expansion memory size: 0

Example 4: Your PC AT has 512 KB of conventional memory installed, and you have a 2-MB Rampage 286 board. You want to use 128 KB of Rampage 286 memory to fill out conventional memory to 640 KB, 384 KB as extended memory, and all remaining memory (1536 KB, 2048 minus 128 minus 384) as expanded memory. Specify:

Base memory size: 640
Expansion memory size: 384

Example 5: Your PC AT has 256 KB of conventional memory installed, and you have one 2-MB Rampage 286 board and one 2-MB *Advantage!* board. You want to use 384 KB of Rampage 286 memory to fill out conventional memory to 640 KB, 1 MB as expanded (paged) memory, and all remaining memory (2688 KB) as extended memory (memory addressed above 1 MB). Specify:

Base memory size: 640
Expansion memory size: 2688

NOTE

Enhanced Expanded Memory Specification software (such as DESQview) works best when as much Rampage 286 memory as possible is allocated as conventional memory. Appendix B tells you how to allocate memory if you will be using DESQview.

If you have a PC AT, it is possible to allocate as much as 384 KB of Rampage 286 memory as conventional memory.

If you have a PC XT Model 286 with 512 KB installed, you can allocate up to 128 KB of Rampage 286 memory as conventional memory. If your PC XT Model 286 has 640 KB installed, do not allocate any Rampage 286 memory as conventional memory.

INSTALLING RAMPAGE 286 SOFTWARE

5

NOTE

You must use a version 6.10 (or later) SuperPak diskette with Rampage 286 to receive the correct REMM and INSTALL programs. For information on the SuperPak utilities, see your *SuperPak User's Manual*. All your SuperPak software is fully downward-compatible, and can be used in place of any earlier SuperPak software you are now using with other AST products.

This section introduces you to the menu-driven INSTALL program. INSTALL allows you to prepare a boot disk that takes advantage of Rampage 286's expanded memory and installs simple configurations of SuperPak programs. This section provides a step-by-step procedure for creating a simple SuperPak configuration using INSTALL. Detailed procedures for creating and modifying each SuperPak program are provided in Appendix D.

INSTALL places simple, basic configurations of the following SuperPak programs on your boot disk:

- *REMM.SYS*, the AST expanded memory manager that allows Expanded Memory and Enhanced Expanded Memory Specifications applications programs to use your Rampage 286 expanded memory. (An additional program, *REX.SYS*, is also automatically installed when you install AST Random Access Memory drives and/or print spooler software using memory beyond 640 KB). You must have *REMM.SYS* installed before your application programs can use Rampage 286 expanded memory.

- *fASTdisk*, a RAM disk that emulates a fixed disk drive.
- *SuperDrive*, a RAM disk that emulates a floppy diskette drive.
- *SuperSpool*, a print spooling buffer that allows you to continue using your computer while your files print.

NOTE

To run the INSTALL program, you must have either two floppy diskette drives, or one floppy diskette drive and a hard disk unit.

To install the programs listed above on your boot disk, the INSTALL program copies the needed SuperPak program files onto the boot disk and adds statements to the AUTOEXEC.BAT and CONFIG.SYS files on your boot disk. AUTOEXEC.BAT is a batch file that contains commands that are automatically executed when you boot up your computer. CONFIG.SYS contains the software drivers that allow devices that are external to your computer (such as REMM, REX and fASTdisk) to function.

If AUTOEXEC.BAT and CONFIG.SYS files do not already exist on your boot disk, INSTALL will create them for you. If those files do already exist on your boot disk, any existing statements not changed by the new installation will remain. If necessary, some preexisting statements will be changed. INSTALL appends any new statements to the end of existing AUTOEXEC.BAT and CONFIG.SYS files.

5.1 Example SuperPak Configuration

Instructions follow for using INSTALL to create this typical SuperPak software configuration:

- Installation of the programs that allow EMS and EEMS applications to use expanded memory — REMM.SYS (Rampage expanded memory manager), and REX.SYS (which is automatically installed transparently to you when you install AST RAM drives and print spooler software using memory outside of conventional memory (0-640 KB)).
- One 512-kilobyte (KB) RAM disk that emulates a fixed disk drive (fASTdisk).
- One 360-KB RAM disk that emulates a floppy diskette drive (SuperDrive).
- One 64-KB RAM print spooling buffer, which frees your computer for other work while your files print (SuperSpool). It is assumed that you are sending output to a parallel printer port.

To install all the software listed above would require a minimum of 936 KB of memory available, not counting memory needed for application programs. You do not have to create a fASTdisk, SuperDrive, or SuperSpool. However, you must install REMM.SYS in order to let your EMS and EEMS programs use Rampage 286 expanded memory.

NOTE

Before you install fASTdisk, SuperDrive, or SuperSpool on your boot disk, be sure to remove any RAM disk or print spooler programs that you might already have on your boot disk.

The instructions given here should be adequate for most users, but if you want to customize your boot disk, see Appendix D. Also see Appendix D if you want to prepare a boot disk for another computer besides the system on which you are running the INSTALL program, or have any questions about the procedure described in this section.

NOTE

If you are planning to create a SuperDrive, you should first run SETUP to make sure you have configured your system to include the SuperDrive RAM diskette drive.

5.2 Starting the INSTALL Program

To start the INSTALL program, follow these steps:

STEP 1

Back up the SuperPak diskette: Make a backup copy of the SuperPak diskette using the Disk Operating System (DOS) COPY command. Store the master diskette in a safe place. You can then use the master diskette to back up your software if your working disk is lost or damaged.

STEP 2

Prepare a DOS system disk: You can either install SuperPak software on your existing DOS boot diskette or hard disk, or you can create a new boot disk.

To create a new boot diskette, format a blank diskette by entering the following DOS command from a disk or diskette drive where DOS files are present:

FORMAT n:/S<Enter>

where n: represents the diskette drive where the blank diskette resides.

If you want to boot from your hard disk, make sure the file COMMAND.COM is in your root directory.

STEP 3

Insert DOS system disk in drive B: or change to root directory for hard disk: If you want to boot from a floppy diskette, insert the DOS system disk you made in STEP 2 into drive B:. If you want to boot from the hard disk, make sure the root directory is the default.

STEP 4

Start the program: With the backup copy of your SuperPak diskette in the default drive, enter this command after the DOS prompt:

INSTALL<Enter>

NOTE

To ensure proper operation, run INSTALL from DOS, not from another program such as DESQview.

The initial INSTALL screen shown in Figure 5-1 appears:

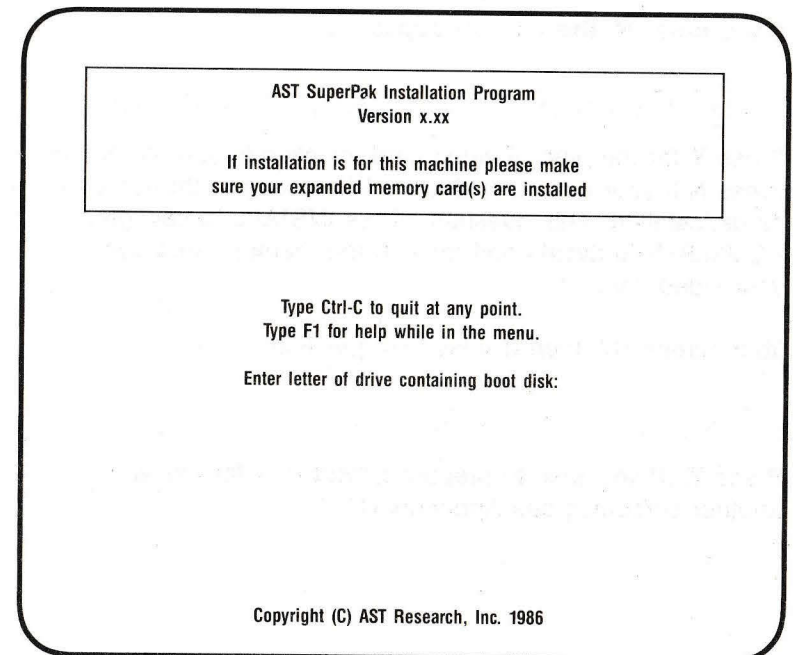

Figure 5-1. Initial INSTALL Screen.

STEP 5

Enter letter of drive containing boot disk: After the prompt, enter the letter of the drive containing the DOS system disk you created in STEP 2 (or the letter for your hard drive). Do *not* enter the letter of the drive containing your SuperPak diskette.

STEP 6

Identify the type of display adapter you are using:

The following question will then appear on your screen:

Is your video card one of the following (Y/N)?

- IBM Monochrome Adapter or compatible
- Hercules Graphics Adapter or compatible

If you press **N**, this line will appear:

- IBM Color Graphics Adapter or compatible

If you press **N**, this line will appear:

- IBM Enhanced Graphics Adapter or compatible

Press **Y** for the type of video card installed in your computer. Press **N** if your computer does not have one of those video cards installed. This question allows INSTALL to configure REMM.SYS to avoid conflicts with the memory area used by your video card.

Your screen will then display this question:

Is installation for this machine (Y/N)?

Press **Y**. (If you wish to prepare a boot disk for use with another computer, see Appendix D.)

Pressing **Y** causes this message to be displayed on the screen:

Testing for expanded memory boards...

Next, the main menu shown in Figure 5-2 appears.

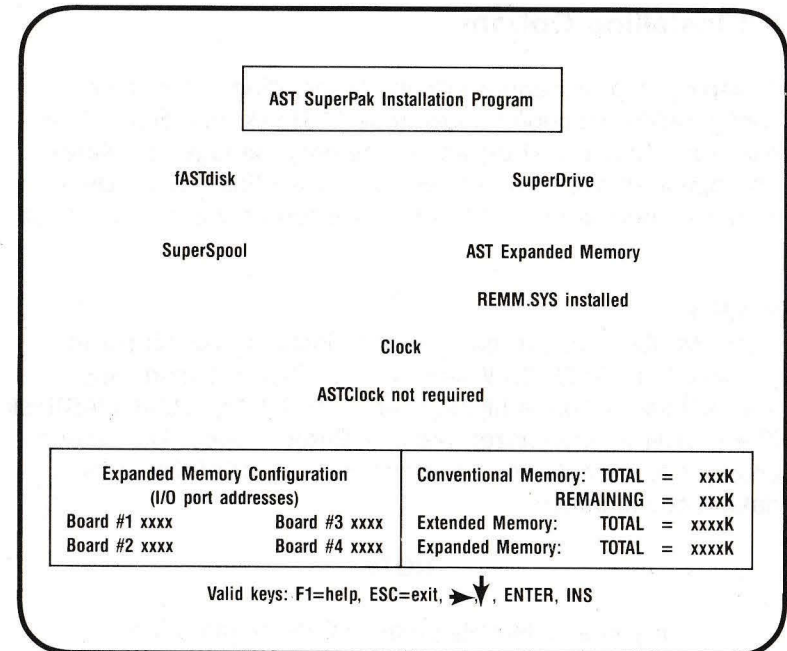

Figure 5-2. Main INSTALL Menu.

Notice that the amounts of conventional, extended, and expanded memory you selected with the Rampage 286 hardware switches SW1 and SW2 automatically appear at the bottom of the screen. For conventional memory, both the total amount and the remaining amount that has not been allocated are shown.

The amount of extended memory shown refers to actual extended memory and/or expanded memory that *emulates* extended memory.

As you progress, you will notice that as extended memory is allocated, it may be subtracted from expanded memory. This indicates that extended memory is "borrowing" from expanded memory (that is, expanded memory is emulating extended memory).

5.3 Installing Options

A step-by-step procedure follows for installing the sample configuration described above (one fASTdisk, one SuperDrive, one SuperSpool, and expanded memory manager software). The option of skipping over creating a fASTdisk, SuperDrive, or SuperSpool is included in the procedures that are provided.

STEP 1

Install fASTdisk: (If you don't want to install a 512-KB fASTdisk, go directly to STEP 2.) When the main INSTALL menu appears, the fASTdisk option is highlighted. To install one 512-KB fASTdisk (the default memory size), press <Enter> once. The screen changes to indicate you have installed one fASTdisk in its default configuration.

NOTE

If you accidentally press <Enter> more than once, you will install a second fASTdisk. To delete the second fASTdisk, press the **Down Arrow key** to highlight the second fASTdisk listing and press .

STEP 2

Install SuperDrive: (If you don't want to create a SuperDrive, go to STEP 3). To install a 360-KB SuperDrive, press the **Right Arrow key** to highlight the SuperDrive option. Press <Enter> once. A line will appear describing the SuperDrive you have created. It lists the memory size of the SuperDrive (which should be 360 KB) and the drive letter of the SuperDrive.

The drive letter for the SuperDrive you have created on a PC AT should be either A: or B:. For example, if you have a floppy drive A:, then your SuperDrive should be designated as B: (the default). If the drive letter provided by INSTALL is not appropriate for your configuration, then you will have to "edit" the SuperDrive you have created.

To edit your SuperDrive, highlight the SuperDrive you have created, then press <Enter> to invoke the INSTALL edit box. Select the device letter parameter by pressing the down arrow key. Then press the Right- or Left-Arrow key to select the device letter you wish to use. Once the correct letter appears, press <Esc> to exit the edit box, leaving your SuperDrive with the new device letter you have selected.

STEP 3

Install SuperSpool: (If you don't want to create a SuperSpool buffer, go to STEP 4). To create a 64-KB SuperSpool buffer, press the right-arrow to highlight the SuperSpool option. Press <Enter> once.

STEP 4

Install Expanded Memory Manager: As long as the message "REMM.SYS installed" appears on the main menu, the REMM.SYS and, if needed, REX.SYS software are installed automatically when you save the installation. If the message "REMM.SYS not installed" appears, you can change it to "REMM.SYS installed" by pressing the Right-Arrow key to highlight "AST Expanded Memory", then pressing <Enter>.

5.4 Save the Installation

To save the installation on your boot disk, follow the procedure below.

STEP 1

Save the configuration: First press <Esc>. The following question appears at the bottom of your screen:

Are you sure you want to quit (Y/N)?

Press **Y**. A further question then appears:

Do you want to save configuration (y/n)?

Press **Y**. These messages appear at the bottom of the screen:

Writing CONFIG.SYS to x: . . .

Writing AUTOEXEC.BAT to x: . . .

where x: is the drive containing the boot disk.

STEP 2

Copy utility files to boot disk. The screen clears, then shows this message:

For the configuration process to be complete, the following SuperPak utility files need to be present on your boot disk:

The above message is followed by a list of files necessary to install your SuperPak software, and this question is displayed:

Do you want these files copied to your boot disk (Y/N)?:

Press **Y**.

Place your SuperPak diskette in drive A: if it is not already there. The following message will appear:

Enter the letter of the disk drive containing your SuperPak software:

Enter the drive letter for the drive that contains your SuperPak software.

This concludes the procedure for creating a sample SuperPak boot disk. You must reboot the system with your new boot diskette to use Rampage 286 expanded memory (including your fASTdisk and SuperDrive RAM disks, and the SuperSpool print spooler). If you have added a SuperDrive RAM disk that has not already been declared to the SETUP program, then you will need to run SETUP to let your computer know that you have added a RAM floppy disk. Section 4 provides further information about the SETUP program.

NOTES

SWITCH SETTING SUMMARY

A

This appendix summarizes all of the switch and jumper settings for the Rampage 286 board.

A.1 Rampage 286 Conventional/Extended Memory Size

Figure A-1 shows the Rampage 286 conventional/extended memory size settings. Conventional memory is the user-addressable memory between 0 and 640 kilobytes. Extended memory is the non paged memory above 1 megabyte and can be added until the computer's limit of 16 MB is reached. Conventional or extended memory cannot be allocated in the 640-KB to 1-MB range.

Each enabled 128-KB block of conventional/extended memory is allocated as conventional memory until a total of 640 KB of conventional memory is present. Any additional conventional/extended Rampage 286 memory is then allocated as extended memory. All remaining Rampage 286 memory is then allocated as expanded (paged) memory.

For example, your PC AT has 256 KB of conventional memory already installed on the system board, and you are installing a Rampage 286 with 2 MB of memory. If you allocate 1024 KB (1 MB) of that memory as conventional/extended (linear) memory (SW1-1 ON, and SW1-2, SW1-3, and SW1-4 OFF):

- 384 KB is used to round out conventional memory to its 640-KB limit.
- 768 KB is allocated as extended memory.
- The remaining 1 MB of Rampage 286 memory is allocated as expanded (paged) memory.

NOTE

To prevent parity errors, do not set Rampage 286 conventional/extended memory size for more memory than is actually installed on Rampage 286. For example, if only 512 KB is installed on Rampage 286, do not set the Rampage 286 conventional/extended memory size to 640 KB.

To allocate all Rampage 286 memory as expanded (paged) memory, simply set the conventional/extended memory already installed (Section A.4) to 16 MB (SW2-1 through SW2-7 all OFF). This ensures that no Rampage 286 memory is allocated as conventional or extended memory, regardless of the conventional/extended memory size setting.

Rampage 286

Conventional/Extended Memory Size

| | SW1-1 | SW1-2 | SW1-3 | SW1-4 |
|----------|-------|-------|-------|-------|
| * 128 KB | ON | ON | ON | ON |
| 256 KB | ON | ON | ON | OFF |
| 384 KB | ON | ON | OFF | ON |
| 512 KB | ON | ON | OFF | OFF |
| 640 KB | ON | OFF | ON | ON |
| 768 KB | ON | OFF | ON | OFF |
| 896 KB | ON | OFF | OFF | ON |
| 1024 KB | ON | OFF | OFF | OFF |
| 1152 KB | OFF | ON | ON | ON |
| 1280 KB | OFF | ON | ON | OFF |
| 1408 KB | OFF | ON | OFF | ON |
| 1536 KB | OFF | ON | OFF | OFF |
| 1664 KB | OFF | OFF | ON | ON |
| 1792 KB | OFF | OFF | ON | OFF |
| 1920 KB | OFF | OFF | OFF | ON |
| 2048 KB | OFF | OFF | OFF | OFF |

* Default setting.

NOTE

If Rampage 286 is configured for all of its memory to be used as expanded memory (for example, switches SW2-1 through SW2-7 OFF) the above linear memory size settings will be ignored.

This switch block is shown in the wrong orientation. Has been corrected in the replacement page A-3, located in the addendum at the rear.

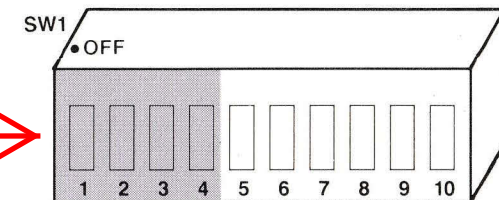

Figure A-1. Rampage 286 Conventional/Extended Memory Size.

NOTE

You can use the REX.SYS program to configure Rampage 286 expanded memory as extended (for random access memory disks and print spoolers only) memory without resetting Rampage 286 hardware switches. However, the reverse is not true: you cannot override the setting for conventional/extended memory size to allocate extended memory as expanded memory.

To reconfigure Rampage 286 expanded memory as extended memory without resetting board switches, you must add or modify the DEVICE=REX.SYS statement in your CONFIG.SYS file, or use the INSTALL program (described in Section 4).

A.2 Base I/O Address

Figure A-2 shows the Rampage 286 base I/O address settings. This setting defines the base I/O address used by Rampage 286 to communicate with the computer so that it can make use of expanded memory.

If more than one AST expanded memory board is installed in a computer, each must use a different base I/O address. To prevent I/O address conflicts, make sure that no other devices in the computer uses the same base I/O address or associated I/O addresses.

This switch block is shown in the wrong orientation. Has been corrected in the replacement page A-5, located in the addendum at the rear.

NOTE

When you select base I/O address 02x8h, Rampage 286 uses these associated addresses:

02x8h, 42x8h, 82x8h, C2x8h,
02x9h, 42x9h, 82x9h, C2x9h

For example, selecting base I/O address 0208h causes the Rampage 286 board to use I/O addresses 0208h, 4208h, 8208h, C208h, 0209h, 4209h, 8209h, and C209h.

| Base I/O Address | Rampage 286 Switch Settings | | | |
|------------------|-----------------------------|-------|-------|-------|
| | SW1-5 | SW1-6 | SW1-7 | SW1-8 |
| 0208 | ON | ON | ON | ON |
| *0218 | ON | ON | ON | OFF |
| 0258 | ON | OFF | ON | OFF |
| 0268 | ON | OFF | OFF | ON |
| 02A8 | OFF | ON | OFF | ON |
| 02B8 | OFF | ON | OFF | OFF |
| 02E8 | OFF | OFF | OFF | ON |

*Default setting

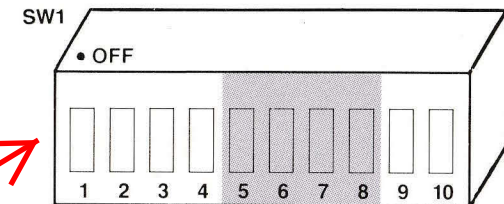
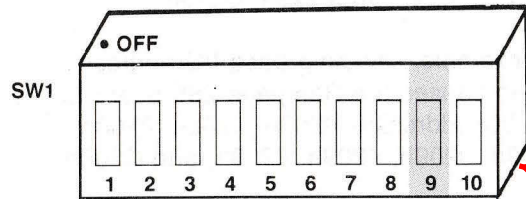

Figure A-2. Rampage 286 Base I/O Address Settings.

A.3 Dual Page Mode

Figure A-3 shows how to enable or disable Dual Page mode. Dual Page mode allows expanded memory to maintain two sets of mapping registers, which ensures proper multitasking operation. Generally, Dual Page mode is left enabled.



SW1-9 ON = dual page mode enabled
 SW1-9 OFF = dual page mode disabled

Figure A-3. Dual Page Mode Configuration.

This switch block is shown in the wrong orientation. Has been corrected in the replacement page A-6, located in the addendum at the rear.

A.4 Conventional/Extended Memory Already Installed

Figure A-4 shows the possible Rampage 286 settings for conventional/extended (linear) memory already installed. This setting tells Rampage 286 how much conventional and extended memory is already installed in your computer, and prevents parity errors at power on during memory sizing.

Please note that this parameter does not include the memory between 640 KB and 1 MB. For example, if your computer includes 640 KB of conventional memory and 128 KB of extended memory, the setting for conventional/extended (linear) memory already installed is 768 KB (SW2-1 through SW2-4 ON, SW2-5 through SW2-7 OFF).

NOTE

To allocate all Rampage 286 memory as expanded (paged) memory, simply set the conventional/extended memory already installed to 16 MB (SW2-1 through SW2-7 all OFF). If this is done, the settings for switches SW1-1 through SW1-4 are ignored.

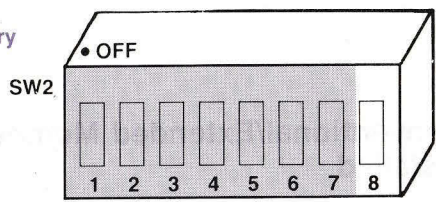

These switch blocks are shown in the wrong orientation. Has been corrected in the replacement page A-8 and A-9, located in the addendum at the rear.

Non-Paged Memory Already Installed

| | SW2-1 | SW2-2 | SW2-3 | SW2-4 | SW2-5 | SW2-6 | SW2-7 |
|---------|-------|-------|-------|-------|-------|-------|-------|
| 0 KB | ON | ON | ON | ON | ON | ON | ON |
| 128 KB | ON | ON | ON | ON | ON | ON | OFF |
| 256 KB | ON | ON | ON | ON | ON | OFF | ON |
| 384 KB | ON | ON | ON | ON | ON | OFF | OFF |
| 512 KB* | ON | ON | ON | ON | OFF | ON | ON |
| 640 KB | ON | ON | ON | ON | OFF | ON | OFF |
| 768 KB | ON | ON | ON | ON | OFF | OFF | ON |
| 896 KB | ON | ON | ON | ON | OFF | OFF | OFF |
| 1024 KB | ON | ON | ON | OFF | ON | ON | ON |
| 1152 KB | ON | ON | ON | OFF | ON | ON | OFF |
| 1280 KB | ON | ON | ON | OFF | ON | OFF | ON |
| 1408 KB | ON | ON | ON | OFF | ON | OFF | OFF |
| 1536 KB | ON | ON | ON | OFF | OFF | ON | ON |
| 1664 KB | ON | ON | ON | OFF | OFF | ON | OFF |
| 1792 KB | ON | ON | ON | OFF | OFF | OFF | ON |
| 1920 KB | ON | ON | ON | OFF | OFF | OFF | OFF |
| 2048 KB | ON | ON | OFF | ON | ON | ON | ON |
| 2176 KB | ON | ON | OFF | ON | ON | ON | OFF |
| 2304 KB | ON | ON | OFF | ON | ON | OFF | ON |
| 2432 KB | ON | ON | OFF | ON | ON | OFF | OFF |
| 2560 KB | ON | ON | OFF | ON | ON | ON | ON |
| 2688 KB | ON | ON | OFF | ON | OFF | ON | OFF |
| 2816 KB | ON | ON | OFF | ON | OFF | ON | ON |
| 2944 KB | ON | ON | OFF | ON | OFF | OFF | ON |
| 3072 KB | ON | ON | OFF | OFF | ON | ON | ON |
| 3200 KB | ON | ON | OFF | OFF | ON | ON | OFF |
| 3328 KB | ON | ON | OFF | OFF | ON | OFF | ON |
| 3456 KB | ON | ON | OFF | OFF | ON | OFF | OFF |
| 3584 KB | ON | ON | OFF | OFF | OFF | ON | ON |
| 3712 KB | ON | ON | OFF | OFF | OFF | ON | OFF |
| 3840 KB | ON | ON | OFF | OFF | OFF | ON | OFF |
| 3968 KB | ON | ON | OFF | OFF | OFF | OFF | ON |
| 4096 KB | ON | OFF | ON | ON | ON | ON | ON |
| 4224 KB | ON | OFF | ON | ON | ON | ON | OFF |
| 4352 KB | ON | OFF | ON | ON | ON | OFF | ON |
| 4480 KB | ON | OFF | ON | ON | ON | OFF | OFF |
| 4608 KB | ON | OFF | ON | ON | OFF | ON | ON |
| 4736 KB | ON | OFF | ON | ON | OFF | ON | OFF |
| 4864 KB | ON | OFF | ON | ON | OFF | OFF | ON |
| 4992 KB | ON | OFF | ON | ON | OFF | OFF | ON |
| 5120 KB | ON | OFF | ON | OFF | ON | ON | OFF |
| 5248 KB | ON | OFF | ON | OFF | ON | ON | ON |
| 5376 KB | ON | OFF | ON | OFF | ON | OFF | OFF |
| 5504 KB | ON | OFF | ON | OFF | OFF | ON | ON |
| 5632 KB | ON | OFF | ON | OFF | OFF | ON | OFF |
| 5760 KB | ON | OFF | ON | OFF | OFF | ON | OFF |
| 5888 KB | ON | OFF | ON | OFF | OFF | OFF | ON |
| 6016 KB | ON | OFF | ON | OFF | OFF | OFF | ON |
| 6144 KB | ON | OFF | OFF | ON | ON | ON | ON |
| 6272 KB | ON | OFF | OFF | ON | ON | ON | OFF |
| 6400 KB | ON | OFF | OFF | ON | ON | OFF | ON |
| 6528 KB | ON | OFF | OFF | ON | ON | OFF | ON |
| 6656 KB | ON | OFF | OFF | ON | OFF | ON | ON |
| 6784 KB | ON | OFF | OFF | ON | OFF | ON | OFF |
| 6912 KB | ON | OFF | OFF | ON | OFF | ON | OFF |
| 7040 KB | ON | OFF | OFF | ON | OFF | OFF | ON |
| 7168 KB | ON | OFF | OFF | OFF | ON | ON | ON |
| 7296 KB | ON | OFF | OFF | OFF | ON | ON | OFF |
| 7424 KB | ON | OFF | OFF | OFF | ON | OFF | ON |
| 7552 KB | ON | OFF | OFF | OFF | ON | OFF | ON |
| 7680 KB | ON | OFF | OFF | OFF | OFF | ON | ON |
| 7808 KB | ON | OFF | OFF | OFF | OFF | ON | OFF |
| 7936 KB | ON | OFF | OFF | OFF | OFF | ON | OFF |
| 8064 KB | ON | OFF | OFF | OFF | OFF | ON | OFF |

* Default setting

NOTE

Do not count memory in the 640 KB-1 MB range when determining the amount of conventional/extended memory already installed.

A-8 Figure A-4. Conventional/Extended Memory Already Installed.

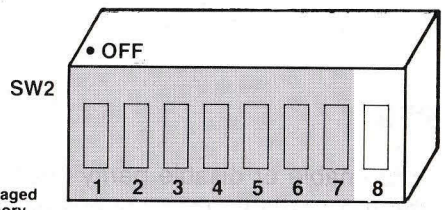

Non-Paged Memory Already Installed

| | SW2-1 | SW2-2 | SW2-3 | SW2-4 | SW2-5 | SW2-6 | SW2-7 |
|-----------------|-------|-------|-------|-------|-------|-------|-------|
| 8192 KB | ON | ON | ON | ON | ON | ON | ON |
| 8320 KB | OFF | ON | ON | ON | ON | ON | ON |
| 8448 KB | OFF | ON | ON | ON | ON | ON | OFF |
| 8576 KB | OFF | ON | ON | ON | ON | OFF | ON |
| 8704 KB | OFF | ON | ON | ON | ON | OFF | OFF |
| 8832 KB | OFF | ON | ON | ON | ON | OFF | ON |
| 8960 KB | OFF | ON | ON | ON | ON | OFF | OFF |
| 9088 KB | OFF | ON | ON | ON | ON | OFF | OFF |
| 9216 KB | OFF | ON | ON | ON | ON | OFF | OFF |
| 9344 KB | OFF | ON | ON | OFF | ON | ON | ON |
| 9472 KB | OFF | ON | ON | OFF | ON | ON | OFF |
| 9600 KB | OFF | ON | ON | OFF | ON | OFF | ON |
| 9728 KB | OFF | ON | ON | OFF | OFF | ON | ON |
| 9856 KB | OFF | ON | ON | OFF | OFF | ON | OFF |
| 9984 KB | OFF | ON | ON | OFF | OFF | OFF | ON |
| 10112 KB | OFF | ON | ON | OFF | OFF | OFF | OFF |
| 10240 KB | OFF | ON | OFF | ON | ON | ON | ON |
| 10368 KB | OFF | ON | OFF | ON | ON | ON | OFF |
| 10496 KB | OFF | ON | OFF | ON | ON | OFF | ON |
| 10624 KB | OFF | ON | OFF | ON | ON | OFF | OFF |
| 10752 KB | OFF | ON | OFF | ON | OFF | ON | ON |
| 10880 KB | OFF | ON | OFF | ON | OFF | ON | OFF |
| 11008 KB | OFF | ON | OFF | ON | OFF | OFF | ON |
| 11136 KB | OFF | ON | OFF | ON | OFF | OFF | OFF |
| 11264 KB | OFF | ON | OFF | OFF | ON | ON | ON |
| 11392 KB | OFF | ON | OFF | OFF | ON | ON | OFF |
| 11520 KB | OFF | ON | OFF | OFF | ON | OFF | ON |
| 11648 KB | OFF | ON | OFF | OFF | ON | OFF | OFF |
| 11776 KB | OFF | ON | OFF | OFF | OFF | ON | ON |
| 11904 KB | OFF | ON | OFF | OFF | OFF | ON | OFF |
| 12032 KB | OFF | ON | OFF | OFF | OFF | OFF | ON |
| 12160 KB | OFF | ON | OFF | OFF | OFF | OFF | OFF |
| 12288 KB | OFF | OFF | ON | ON | ON | ON | ON |
| 12416 KB | OFF | OFF | ON | ON | ON | ON | OFF |
| 12544 KB | OFF | OFF | ON | ON | ON | OFF | ON |
| 12672 KB | OFF | OFF | ON | ON | ON | OFF | OFF |
| 12800 KB | OFF | OFF | ON | ON | OFF | ON | ON |
| 12928 KB | OFF | OFF | ON | ON | OFF | ON | OFF |
| 13056 KB | OFF | OFF | ON | ON | OFF | OFF | ON |
| 13184 KB | OFF | OFF | ON | ON | OFF | OFF | OFF |
| 13312 KB | OFF | OFF | ON | OFF | ON | ON | ON |
| 13340 KB | OFF | OFF | ON | OFF | ON | ON | OFF |
| 13368 KB | OFF | OFF | ON | OFF | ON | OFF | ON |
| 13396 KB | OFF | OFF | ON | OFF | ON | OFF | OFF |
| 13824 KB | OFF | OFF | ON | OFF | OFF | ON | ON |
| 13952 KB | OFF | OFF | ON | OFF | OFF | ON | OFF |
| 14080 KB | OFF | OFF | ON | OFF | OFF | OFF | ON |
| 14208 KB | OFF | OFF | ON | OFF | OFF | OFF | OFF |
| 14366 KB | OFF | OFF | OFF | ON | ON | ON | ON |
| 14464 KB | OFF | OFF | OFF | ON | ON | ON | OFF |
| 14592 KB | OFF | OFF | OFF | ON | ON | OFF | ON |
| 14720 KB | OFF | OFF | OFF | ON | ON | OFF | ON |
| 14848 KB | OFF | OFF | OFF | ON | ON | OFF | OFF |
| 14976 KB | OFF | OFF | OFF | ON | OFF | ON | ON |
| 15104 KB | OFF | OFF | OFF | ON | ON | ON | OFF |
| 15232 KB | OFF | OFF | OFF | ON | OFF | OFF | ON |
| 15360 KB | OFF | OFF | OFF | OFF | ON | ON | OFF |
| 15488 KB | OFF | OFF | OFF | OFF | ON | ON | ON |
| 15616 KB | OFF | OFF | OFF | OFF | ON | OFF | ON |
| 15744 KB | OFF | OFF | OFF | OFF | ON | OFF | OFF |
| 15872 KB | OFF | OFF | OFF | OFF | OFF | ON | ON |
| All RAMpage | OFF | OFF | OFF | OFF | OFF | OFF | OFF |
| AT memory paged | OFF | OFF | OFF | OFF | OFF | OFF | OFF |

NOTE

Do not count memory in the 640 KB-1 MB range when determining the amount of conventional/extended memory already installed.

Figure A-4. Conventional/Extended Memory Already Installed (Continued). A-9

A.5 Parity Checking

Figure A-5 shows how to enable or disable parity error checking. To ensure the most reliable memory operation, leave parity checking enabled.

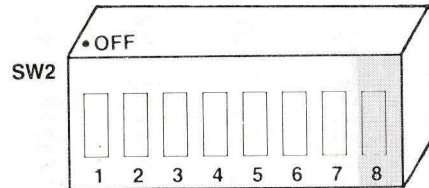

This switch block is shown in the wrong orientation. Has been corrected in the replacement page A-10, located in the addendum at the rear.

SW2-8 ON = Parity checking enabled (default setting).

SW2-8 OFF = Parity checking disabled.

Figure A-5. Parity Error Checking.

MEMORY ALLOCATION WITH DESQVIEW

B

This section tells you how to enhance the performance of the DESQview program that comes with Rampage 286. If you plan to use DESQview, you will want to allocate system memory and Rampage 286 memory to maximize DESQview's performance. (The *DESQview User's Manual* provides additional detailed information.)

B.1 Rampage 286 Memory Allocation

For best performance with DESQview, allocate as much Rampage 286 memory as conventional memory (memory in the 0- to 640-KB range) as possible. Any remaining Rampage 286 memory should be allocated as *expanded memory* for best use with DESQview.

- The standard PC XT Model 286 has 640 KB of system memory. In this configuration you cannot allocate any Rampage 286 memory as conventional memory. This will not prevent the DESQview program from working properly. However, depending on the memory requirements of your application programs, swapping to disk may occur. Figure B-1 shows the correct switch settings for using the PC XT Model 286 with DESQview.
- The PC AT can be set to recognize 256 or 512 KB of system board memory. For best performance with DESQview, you should set the computer to recognize 256 KB of system board memory, and allocate 384 KB of Rampage 286 memory as conventional memory. Figure B-3 shows the correct switch settings for using the PC AT with DESQview.

DESQview takes advantage of the enhanced expanded memory specification (EEMS) — it can swap application programs very rapidly into Rampage 286 memory in the 0- to 640-KB range used by the IBM PC disk operating system (DOS). This allows concurrent execution of programs that together use more than 640 KB of memory. For most effective operation, allocate as much Rampage 286 memory as possible as conventional memory.

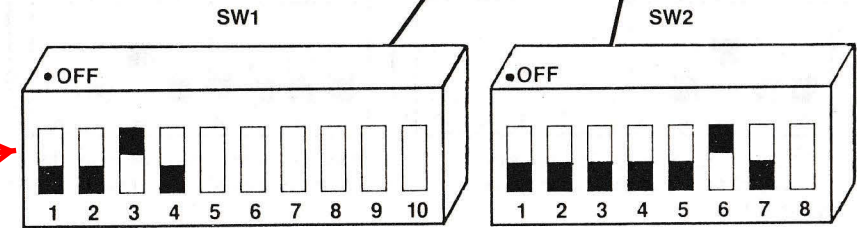
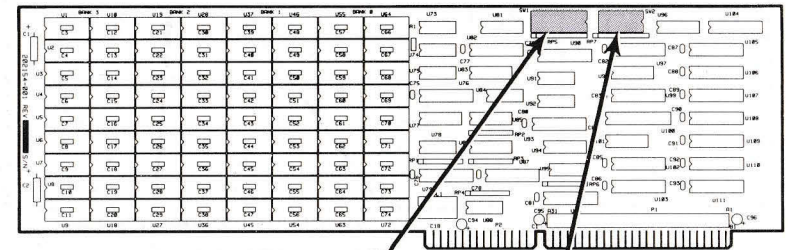

These two switch blocks, SW1 and SW2, are shown in the wrong orientation.

0 KB of Rampage 286 memory allocated as conventional/extended memory . (All expanded.)
 Note: it does not matter how switches are set.

640 KB of convention/extended memory already installed in PC XT Model 286.

Figure B-1. Switch Settings for Best DESQview Performance. (PC XT Model 286 with 640 KB of system memory.)

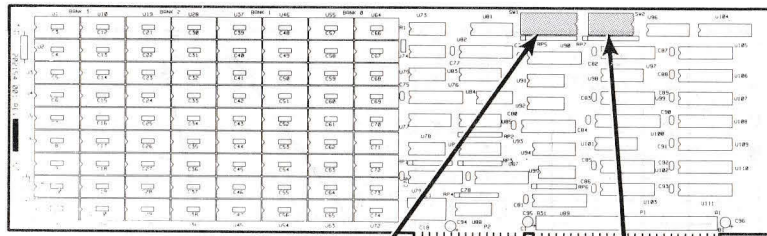

These two switch blocks, SW1 and SW2, are shown in the wrong orientation.

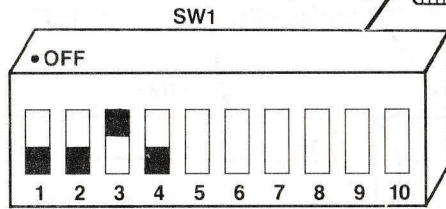

384 KB of Rampage 286 memory allocated as conventional/extended memory.

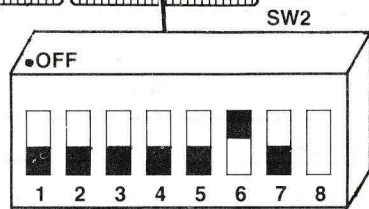

256 KB of convention/ extended memory already installed in PC-AT.

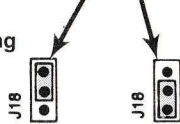
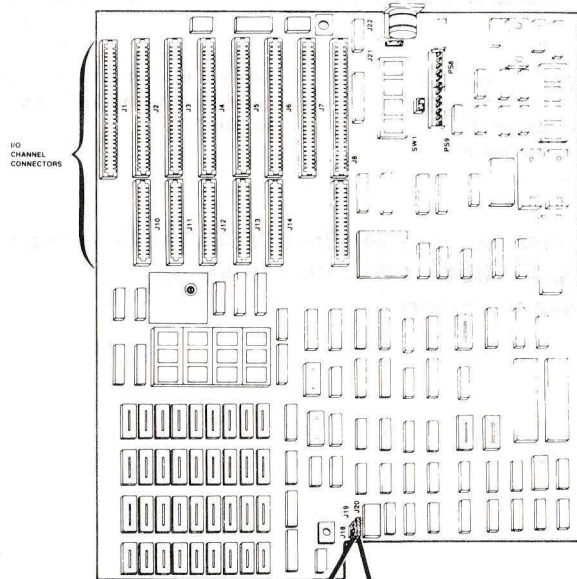

Up to 256 KB of system board memory recognized (use this setting with DESQview).



Up to 512 KB of system board memory recognized.

B.2 Allocating Add-on Board Memory

Your computer may already include an add-on memory board that fills in the area between 256 and 640 KB, such as AST's *Advantage!*. For best DESQview performance, you will need to remove the add-on board or reallocate its memory as *extended memory*, above Rampage 286 memory. Extended memory is memory in the 1- to 16-megabyte (MB) range.

To reallocate an add-on board, set its starting address so that it does not conflict with Rampage 286 memory. For example, if your Rampage 286 board is configured as shown in Figure B-3 (384 KB allocated as conventional/extended memory, and the remainder as expanded memory), then set the add-on board for a starting address of 1 MB (1024 KB).

B.3 Running SETUP

If you have configured your Rampage 286 as described in this section for greatest DESQview efficiency, supply the following parameters when you run the SETUP program:

Base memory size: 640.

Expansion memory size: Any memory allocated as extended memory (for example, memory on an *Advantage!* board or memory set by Rampage 286 hardware switches to be extended memory).

For more information on running the SETUP program, see Section 4.

Figure B-2. Switch Settings for Best DESQview Performance (PC AT).

NOTES

ADDING OR REMOVING MEMORY

C

This section tells you how to install additional memory on Rampage 286. You do not need this information unless you are adding to the memory already installed on your Rampage 286 board.

Section 2 of this manual tells you how to configure Rampage 286 (for conventional/extended memory already installed, conventional/extended memory size, and parity error checking enable/disable) before installing it into your computer.

If your Rampage 286 is not fully populated (that is, if less than 2 MB of memory is installed on the board), you can plug in 256-kilobit (KB) Random Access Memory (RAM) chips to upgrade Rampage 286 memory. You can remove Rampage 286 memory simply by unplugging RAM chips. Figure B-1 shows which memory rows must be populated for each Rampage 286 memory size.

You must add or subtract Rampage 286 memory in 512-KB increments — possible memory capacities are 512 KB, 1 MB, 1.5 MB, and 2 MB. To add memory, you can use the AST upgrade kit, MPAD-512/120, which supplies 18 256-Kilobit (Kb) chips, providing 512 KB of memory.

C.1 Memory Chip Specifications

If you purchase memory chips from another source, be sure they meet the following specifications for use in either 8-MHz or 6-MHz computers.

256-Kb Chip Specification. Use 256-Kb Dynamic Random Access Memory (DRAM) chips with 120 nanosecond (ns) access time. The following manufacturer's 256-Kb (120 ns) memory chips are compatible:

| | |
|-------------------|--------------|
| Fujitsu | MB81256-12P |
| Hitachi | HM50256P-12 |
| Micron | MT1257-12 |
| Motorola | MCM6256P-12 |
| NEC | UPD41256C-12 |
| Samsung | KM41256-12 |
| Texas Instruments | TMS4256-12NL |
| Toshiba | TMM41256P-12 |

C.2 Rules for Adding or Removing Memory

The following rules apply when adding or subtracting memory from your Rampage 286 board:

- For each memory size, all specified rows of chips must be populated entirely with 256-Kb chips (120 nanosecond access time)

NOTE

To ensure compatibility with 8-MHz computers, you must use 120-ns RAM chips to upgrade Rampage 286 memory.

- You must add or subtract Rampage 286 memory in 512-KB increments — possible memory capacities are 512 KB, 1 MB, 1.5 MB, and 2 MB.
- Whenever you add or remove memory, be sure to reset Rampage 286 switches SW1 and SW2 if the Rampage 286 memory configuration changes (including the conventional/extended memory already installed, or Rampage 286 conventional/extended memory size parameters).
- You must run the SETUP program and the INSTALL program any time you add or remove memory from the computer. Section 4 gives several examples of how to run the SETUP program when you install Rampage 286 in your computer.

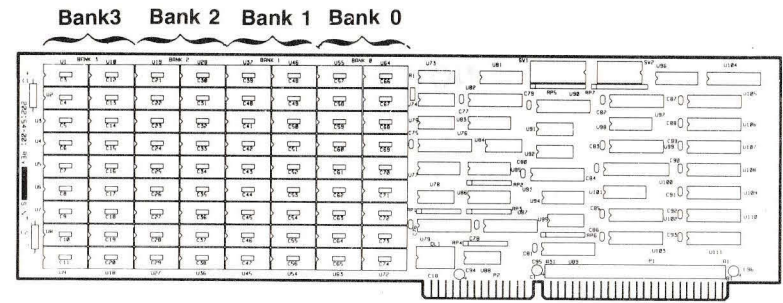

| Amount of RAM | Install RAM in these banks |
|---------------|----------------------------|
| 512 KB | 0 |
| 1 MB | 0, 1 |
| 1.5 MB | 0, 1, 2 |
| 2 MB | 0, 1, 2, 3 |

Figure C-1. Rampage 286 Memory Banks.

NOTES

**ADVANCED
INSTALL PROCEDURES****D**

Section 5 introduced you to the INSTALL program and explained how to use it to install a simple configuration of SuperPak programs on your boot disk. This section provides more advanced information on how to use the INSTALL program, including step-by-step details on how to modify the default operating parameters for each SuperPak program. It is assumed that you have already read Section 5 before reading this section.

You can use the INSTALL program to install the following programs on your boot disk:

- *fASTdisk* — the program that simulates up to two fixed disk drives in RAM. You can change the size and memory type for each *fASTdisk*.
- *SuperDrive* — the program that simulates 360-KB floppy disk drives in RAM (default size 360 KB). INSTALL can install up to two SuperDrives in your system. You can change the letter designation and memory type for each SuperDrive.
- *SuperSpool* — the program that creates a RAM print spooling buffer (default size 64 KB), freeing your computer for other work while your files print. You can change the device name, size, and memory type for the SuperSpool buffer.

- *AST Expanded Memory* — the software that enables expanded memory, providing maximum performance with new EEMS multitasking/windowing software. This software allows you to use expanded memory specification (EMS) programs. You can enable or disable this feature. The expanded memory manager is automatically installed when expanded memory is used to create RAM disks or a print spooler. (In this case expanded memory is made to emulate extended memory, and the REX.SYS program is also installed.)

NOTE

All SuperPak files may not pertain to your particular AST product. Your SuperPak diskette contains a README file that describes which files are applicable to your product. To view the README file, enter:

TYPE README <Enter>

For more information on SuperPak software, see your *SuperPak User's Manual*. For more information on AST expanded memory software, see Appendix E of this manual.

You will have to modify your AUTOEXEC.BAT and/or CONFIG.SYS files (using a text editor) after running INSTALL if you want to send printer output to a serial (not parallel) port, or if you want to use advanced parameters for the SuperPak software. The *SuperPak User's Manual* discusses the SuperPak utilities in greater detail.

D.1 Using INSTALL

For your convenience, INSTALL uses a screen and keyboard interface design similar to popular spreadsheet programs:

The main SuperPak INSTALL menu offers several options (including SuperDrive, SuperSpool, and fASTdisk). To install an option on your boot disk (such as a SuperDrive), you must first select that option by highlighting it, then create the highlighted option by pressing the <Enter> or <Ins> key. When you exit the INSTALL program, all the options you have created are saved on your boot disk.

- The currently selected option is highlighted in reverse video. To move from one option to another, press the right- or left-arrow keys on the numeric keypad to the right of your keyboard.
- Once you have selected (highlighted) an option, you create that option by pressing the <Enter> or <Ins> key.
- Press <F1> to bring up a help screen that corresponds to the currently highlighted option.
- Press <Ctrl>-C to abort the INSTALL program without changing your AUTOEXEC.BAT or CONFIG.SYS files.

If you want to modify the default parameters (such as memory size) for an option you have created, then you need to call up the INSTALL edit box after you have created the option. This is applicable to the fASTdisk, SuperDrive, and SuperSpool options only.

- To call up the INSTALL edit box, highlight the created option you want to modify (for example, one of two fASTdisks you may have created). After this, press <Enter> to invoke the edit box.

- The edit box presents the parameters you can change for the created option you are editing. Select the parameter you want to change by pressing the up- or down-arrow key. If the parameter requires a numeric value, you can enter a new value. If the parameter is for a memory type, device letter or device name, you can press the right- or left-arrow key to select from the available parameters.
- To exit the edit box once you have set the parameters as you want them, press **<Esc>**.
- The cursor appears as an underline character when an alphanumeric entry is required from you.

If you want to delete an option, highlight the option you want to delete (such as SuperDrive). Then press the up-or down-arrow key to select (highlight) the particular created option you want to delete. Next press the **** key to delete the highlighted created option.

Once you have installed and configured your SuperPak options, you can choose to save the installation you have created. When this is done, INSTALL modifies the AUTOEXEC.BAT and CONFIG.SYS files on your boot disk. If those files do not already exist on your boot disk, INSTALL will create them for you. IF those files do already exist on your boot disk, any existing statements not changed by the new installation will remain. INSTALL appends its statements to the end of existing AUTOEXEC.BAT and CONFIG.SYS files.

AUTOEXEC.BAT is a batch file that contains commands that are automatically executed when you boot up your computer. The CONFIG.SYS file installs the software drivers that allow devices that are external to your computer (such as REMM, REX and fASTdisk) to function.

INSTALL first creates fASTdisks, SuperDrives, and the SuperSpool from available extended memory, then uses conventional memory if extended memory is exhausted. If you create a device that is larger than available extended memory, this message is displayed at the bottom of the screen:

Not enough extended memory — switching to conventional

NOTE

There are two ways to allocate Rampage 286 extended memory:

- You can set switches on the board.
- You can rely on AST's expanded memory software to cause *expanded* memory to emulate the required amount of *extended* memory.

If you install AST RAM disks and print spoolers which require more extended memory than what is allocated by hardware switches, the INSTALL program automatically invokes the REX.SYS program. REX.SYS causes Rampage 286 expanded memory to emulate extended memory (assuming sufficient memory is installed on the board).

Each device can be composed of only one memory type (extended or conventional). INSTALL allocates available expanded memory as extended memory only as necessary to create the device.

D.2 Running the INSTALL Program

Full instructions for starting the INSTALL program running are provided in Section 4.2.

D.3 Installing SuperPak Software for Another Computer

After you have started running the INSTALL program (as described in Section 4.2), you will be presented with the following question —

Is installation for this machine (y/n)?:

press **N** if you are installing SuperPak software for another computer. This causes INSTALL to display these questions about the computer for which you are installing software:

Is your computer a PC-AT or AT-compatible (Y/N)?

Enter amount of conventional memory in K bytes:

Enter amount of extended memory in K bytes:

Enter amount of expanded memory in K bytes:

Enter number of floppies and RAM diskettes (1-4):

(These amounts are automatically determined by the INSTALL program if you answered "Y", that you are installing SuperPak software on this computer's boot disk.)

Is your computer a PC XT Model 286, a PC AT or an AT compatible (Y/N)?: Press **Y**.

Enter amount of conventional memory in K bytes: Enter the number of kilobytes (KB) (from **0** to **640**) of conventional memory for the computer whose software you are installing (including any memory allocated from Rampage 286). Conventional memory (as opposed to expanded or extended memory) is the system memory between 0 and 640 KB. Pressing <Enter> is equivalent to entering "0".

Enter amount of extended memory in K bytes: Enter the number of kilobytes (KB) (from **0** to **15360** — **15 MB**) of actual, physical extended memory for the computer whose software you are installing. Extended memory (*not* expanded memory) is the non-paged memory in the 1- to 16-MB range. Pressing <Enter> is equivalent to entering "0".

Enter amount of expanded memory in K bytes: Enter the number of KB (from **0** to **8192** — 8 megabytes (MB)) of expanded memory for the computer whose software you are installing. The amount of expanded memory is the total amount of memory on your AST expanded memory product that is *not* allocated as conventional or extended memory. Pressing <Enter> is equivalent to entering "0".

Examples

Here are some examples of how you would supply the requested memory amounts for several different configurations:

- Your PC AT has 256 KB of system memory and a 2-MB Rampage 286 board. You have allocated 384 KB as conventional memory and 512 KB as extended memory. Enter these parameters:

Conventional memory: **640**

Extended memory: **512**

Expanded memory: **1152** — (2048 minus 512 minus 384)

- Your PC XT Model 286 has 512 KB of system memory and a 2-MB Rampage 286 board. You have allocated 128 KB as conventional memory and all remaining Rampage 286 memory as expanded memory. Enter these parameters:

Conventional memory: **640**

Extended memory: **0**

Expanded memory: **1920** — (2048 minus 128)

- Your PC AT has 256 KB of system memory, a 2-MB Rampage 286, and a 1.5-MB *Advantage!* board. You have allocated all *Advantage!* memory as extended memory, 384 KB of Rampage 286 memory as conventional memory, and all remaining Rampage 286 memory as expanded memory. Enter these parameters:

Conventional memory: **640**
 Extended memory: **1536**
 Expanded memory: **1664** — (2048 minus 384)

Enter number of floppies and RAM diskettes (1-4): Enter the number (on the PC AT and PC XT Model 286, this number must be either 1 or 2) of floppy diskettes (including random access memory (RAM) floppy diskettes, such as SuperDrive), then press <**Enter**>. You will then be presented with the INSTALL main menu.

D.4 INSTALL Main Menu

Once you have installed all the questions in the initial INSTALL screen (described in Section 4.2), the main menu shown in Figure D-1 appears.

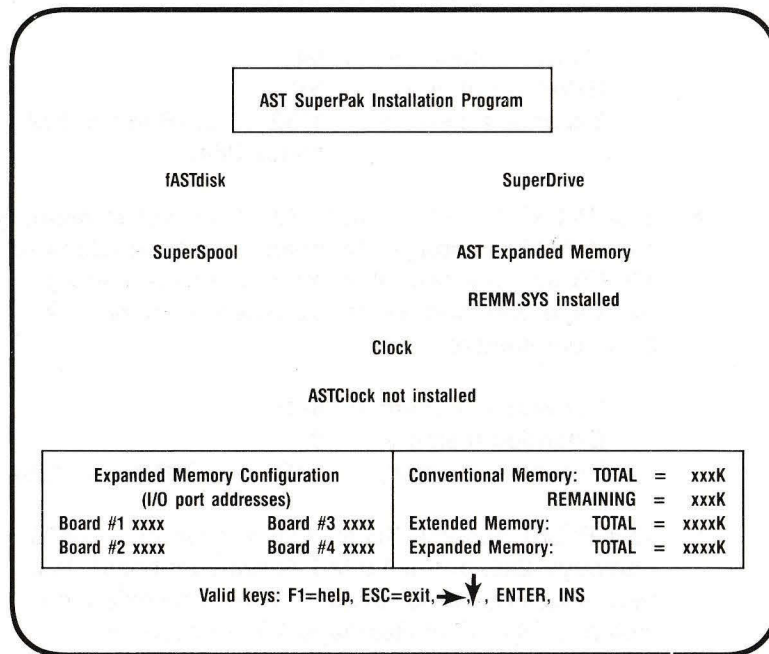

Figure D-1. Main INSTALL Menu.

Notice that the amounts of conventional, extended, and expanded memory you set with your hardware switches (or entered if you are preparing a boot disk for another computer appear at the bottom of the screen. For conventional memory, both the total amount and the remaining amount that has not been allocated are shown.

The amount of extended memory shown refers to actual extended memory and/or expanded memory that *emulates* extended memory.

As you progress, you will notice that as extended memory is allocated, it may be subtracted from expanded memory. This indicates that extended memory is “borrowing” from expanded memory (that is expanded memory is emulating extended memory).

You can install the programs on the Main Menu using the keys as described in Section D.1. Detailed step-by-step procedures follow for installing and modifying each SuperPak program except the Clock program, which is not used with the PC AT. If you attempt to enable the Clock program this message is displayed at the bottom of your screen:

ASTClock not required for PC-AT or compatible

D.5 Installing fASTdisk

This option allows you to create up to two RAM fixed disk drives (default size: 512 KB each).

To create a fASTdisk:

1. Press the right -or left-arrow key to highlight “fASTdisk”.

2. Press **<Enter>** or **<Ins>** once for each fASTdisk you want to create. If you press **<Enter>** more than twice, this message will appear at the bottom of the screen:

Maximum of two fASTdisks allowed

If extended memory is exhausted, the memory totals in the lower right corner of the screen (Figure 4-3) will show 512 KB subtracted from expanded memory, (and added to extended memory) each time you create a fASTdisk. This indicates that fASTdisk is using expanded memory that is emulating extended memory.

To change the size or memory type of a fASTdisk:

1. Press the right- or left-arrow key to highlight "fASTdisk".
2. Press the down-arrow key to highlight the fASTdisk you want to modify (Figure D-2 shows fASTdisk "1" highlighted).
3. Press **<Enter>** to invoke the edit box, shown in Figure D-2.

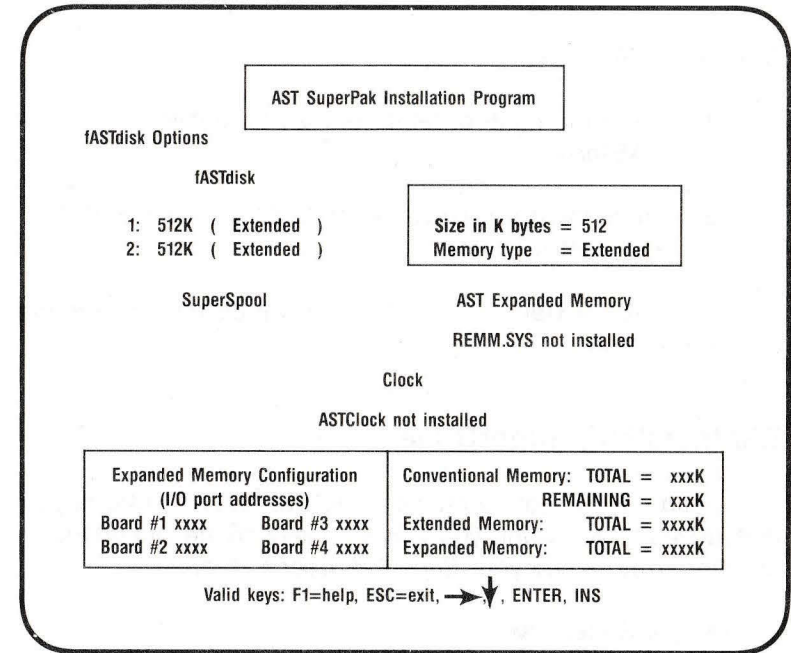

Figure D-2. INSTALL with fASTdisk Edit Box.

4. Press the up- or down-arrow key to highlight the parameter you want to modify (Figure D-2 shows the fASTdisk size parameter highlighted).
5. To change the size: Enter the new size (in KB) of the fASTdisk (from 1 to 9999 KB). Your computer will beep if you enter more than four digits. This message will appear at the bottom of your screen if you enter a non-numeric character:

Input must be a decimal digit

To change the memory type: Press the right- or left-arrow key to select the memory type ("Conventional" or "Extended") you want the fASTdisk to use.

6. Press **<Esc>** to exit the edit box. Notice that the memory allocation at the lower right corner of the screen changes to reflect changes you have made.

To delete a fASTdisk:

1. Press the right- or left-arrow key to highlight "fASTdisk".
2. Press the down-arrow key to highlight the fASTdisk you want to delete.
3. Press — the fASTdisk will disappear from the screen.

D.6 Installing SuperDrive

This option allows you to create up to two 360-KB RAM floppy disk drives (if you want, you can manually create SuperDrives of other sizes — see your *SuperPak User's Manual*).

To create a SuperDrive:

1. Press the right- or left-arrow key to highlight "SuperDrive".
2. Press <Enter> or <Ins> once for each SuperDrive you want to create.

Watch the memory totals at the lower right corner of the screen. (See Figure D-3: if extended memory is exhausted, 360 KB is subtracted from expanded memory, and added to extended memory, each time you create a SuperDrive.)

If you have told the SETUP program that you have one floppy drive (or told INSTALL that the PC-AT for which you are installing SuperPak has one floppy disk drive installed) you will not be able to create a SuperDrive. If you try to create a SuperDrive, this message will be displayed at the bottom of your screen:

Not enough disk devices to add SuperDrive

If you have told the SETUP program that your PC-AT has two floppy drives installed (or told INSTALL that the PC-AT for which you are installing software has two floppy drives), the default drive letter for the first SuperDrive will be B:.

If you attempt to create a third SuperDrive, this message would be displayed at the bottom of your screen:

Maximum of two SuperDrives allowed

To change the drive letter or memory type of a SuperDrive:

1. Press the right- or left-arrow key to highlight "SuperDrive".
2. Press the down-arrow key to highlight the SuperDrive you want to modify (Figure D-3 shows SuperDrive B: highlighted).
3. Press <Enter> to invoke the edit box shown in Figure D-3.

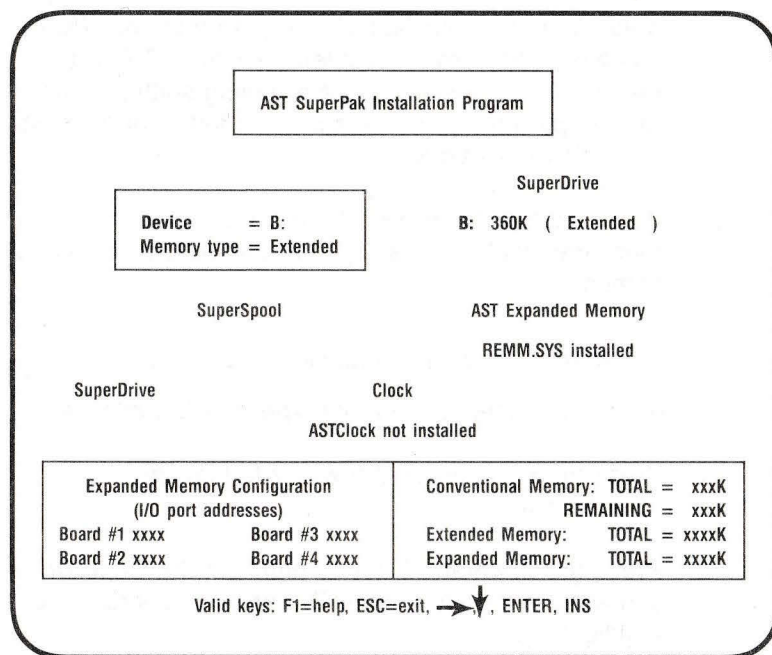

Figure D-3. INSTALL with SuperDrive Edit Box.

4. Press the up- or down-arrow key to highlight "Device" or "Memory type" (Figure D-3 shows "Device" highlighted).
5. To change the letter designation: Press the right- or left-arrow key to select the letter you want (A: or B: on the PC AT).

To change the memory type: Press the right- or left-arrow key to select the memory type ("Conventional" or "Extended") you want the SuperDrive to use.

6. Press <Esc> to exit the edit box. Notice that the memory allocation at the lower right corner of the screen now reflects changes you have made.

To delete a SuperDrive:

1. Press the left- or right-arrow key to highlight "SuperDrive".
2. Press the down-arrow key to highlight the SuperDrive you want to delete.
3. Press to delete the SuperDrive.

D.7 Installing the AST Expanded Memory Manager

This option automatically installs REMM.SYS and REX.SYS in your CONFIG.SYS file. REMM.SYS and REX.SYS are the software drivers that provide expanded memory and allow you to dynamically reconfigure expanded memory as extended memory. You must install REMM.SYS in order to use expanded memory with application programs, or to use memory beyond 640 KB for RAM disks and spoolers.

NOTE

The expanded memory manager software installed by the INSTALL program is appropriate for most applications. However, software developers who want to edit the REMM and REX command lines in the CONFIG.SYS file can use the parameters described in Appendix B. Make sure you're using the version of REMM.SYS that came with your Rampage 286 board.

To install or delete AST expanded memory software:

1. Press the left- or right-arrow key to highlight "AST Expanded Memory Manager".

2. Press <Enter> to select "REMM.SYS installed" or "REMM.SYS not installed". If you press the down-arrow key, this message will appear at the bottom of the screen:

Device can only be enabled or disabled

D.8 Installing SuperSpool

This option allows you to create one RAM print spooler buffer in RAM (default size: 64 KB). Whether or not you use INSTALL, your computer can accommodate only one SuperSpool.

You must edit the SUPERSPL command in the AUTOEXEC.BAT file if you are spooling to a serial printer port or you are changing any default parameter (see your *SuperPak User's Manual* for more details).

INSTALL will first attempt to create a SuperSpool buffer from available extended memory, then uses conventional memory (the buffer is composed of only one memory type — extended or conventional). If you create a SuperSpool that is larger than available extended memory, INSTALL will create a buffer from the extended memory that is available. If no extended memory is available, this message is displayed at the bottom of the screen:

Not enough extended memory — switching to conventional

If no extended or conventional memory is available, this message is displayed at the bottom of the screen:

Not enough memory for spooler

To create a SuperSpool:

1. Press the left- or right-arrow key to highlight "SuperSpool".

2. Press <Enter> to create a SuperSpool.

If you press <Enter> again, this message will be displayed at the bottom of the screen:

Maximum of one spooler allowed

To change the device name, size, or memory type of the SuperSpool buffer:

1. Press the left- or right-arrow key to highlight "SuperSpool".
2. Press the down-arrow key to highlight the SuperSpool buffer ("LPT1:" is highlighted in Figure D-4).
3. Press <Enter> to invoke the edit box shown in Figure D-4.

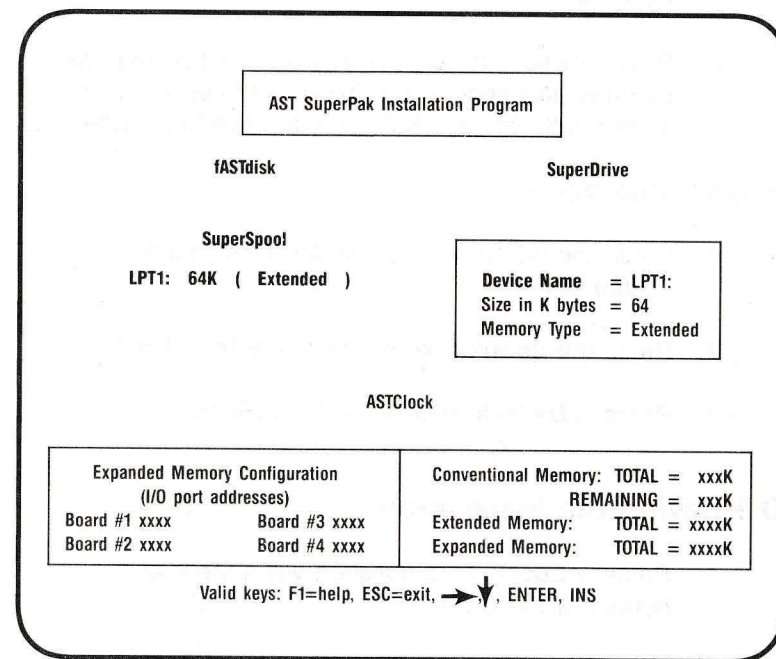

Figure D-4. INSTALL with SuperSpool Edit Box.

- Press the up- or down-arrow key to highlight the parameter you want to modify ("Device Name" is highlighted in Figure D-4).
- To change the device name: Press the left-or right-arrow key to select "LPT1:" or "LPT2:".

To change the size: Enter the new size (in KB) of the SuperSpool (from 1 to 999 KB to a maximum of all available PC-AT memory). Your computer will beep if you enter more than three digits. This message will appear at the bottom of your screen if you enter a non-numeric character:

Input must be a decimal digit

To change the memory type: Press the left- or right-arrow key to select extended or conventional memory.

- Press <Esc> to exit the edit box. Notice that the memory allocation at the lower right corner of the screen reflects any changes you have just made.

To delete SuperSpool:

- Press the left- or right-arrow key to highlight "SuperSpool".
- Press the down-arrow key to highlight "LPTx:".
- Press to delete the SuperSpool.

D.9 Saving the Installation

- Press <Esc>. This question will appear at the bottom of the screen:

Are you sure you want to quit (y/n)?

Press **Y** to exit INSTALL. Press **N** to return to the main INSTALL menu.

- If you press **Y**, this question appears at the bottom of the screen:

Do you want to save configuration (y/n)?

Press **Y** to save the SuperPak software you have just configured using the INSTALL program. Pressing **N** exits INSTALL without making any changes.

- If you save the configuration, these messages flash at the bottom of the screen:

Writing CONFIG.SYS to x: . . .

Writing AUTOEXEC.BAT to x: . . .

where x: is the drive containing the boot disk.

- The screen will then clear and show this message:

For the configuration process to be complete, the following SuperPak utility files need to be present on your boot disk:

The above message is followed by a list of the files necessary to install your SuperPak software, and this question is displayed:

Do you want these files copied to your boot disk (Y/N)?:

- If you press **Y**, your screen will display this message:

Enter the letter of the disk drive containing your SuperPak software:

Enter the letter of the drive that currently contains your SuperPak software. Your screen will then list the appropriate files as they are copied from the SuperPak diskette to your boot disk.

If there is an error copying SuperPak software to your boot disk, this message will be displayed:

Error copying utility files to drive x:

where x: is the letter of the drive containing the boot disk.

Check that the boot disk is not write-protected, that there is enough room on the boot disk for SuperPak files, that the SuperPak software is in the specified drive, and that the disk drives are closed.

6. If you press **N** (do not copy SuperPak files to the boot disk), or once the SuperPak files have been copied, this message appears on your screen:

Configuration is now complete.

You will need to reboot the system for your updated configuration to take effect.

7. Run the SETUP program: You must run SETUP whenever you change the amount of conventional or extended memory, or if you change the number of floppy disk drives (for example, when you install a SuperDrive). Section 5 gives several examples of how to run the SETUP program.
8. Press **<Ctrl>-<Alt>-** to reboot your PC-AT.

D.10 Example of Completed Installation

For example, you have a PC-AT with 256 KB of RAM and an AST *Preview!*™ video display card installed, and you are installing a 2-MB Rampage 286 board (you entered "640" for conventional memory, "384" for extended memory, and "1024" for expanded memory).

If you install one fASTdisk, one SuperDrive B:, one SuperSpool buffer, and enabled AST memory manager software, your AUTOEXEC.BAT and CONFIG.SYS files will contain the following lines at the end of the file (assuming you did not change any default parameters):

| | |
|----------------------|---|
| <i>AUTOEXEC.BAT</i> | <i>CONFIG.SYS</i> |
| superdrv b: /extm | device=remm.sys /x=B000-BFFF /x=E000-EFFF |
| superspl lpt1: /extm | device=rex.sys 936 |
| | device=fastdisk.sys /extm |

NOTES

HOW RAMPAGE 286 WORKS

E

This appendix gives a brief overview of how Rampage 286 works, including memory paging and descriptions of AST expanded memory software modules (REMM.SYS and REX.SYS), and how to modify them if necessary. Although you do not need this information to use Rampage 286, it is provided for those who want some background on how the product functions.

NOTE

Important! To use expanded memory, your boot disk *must* contain REMM.SYS. REX.SYS is also required (along with REMM.SYS) to run RAM disks and print spoolers from expanded memory.

E.1 Memory Paging

By using a technique called *memory paging*, Rampage 286 allows your PC-AT to use *expanded memory* — memory beyond the normal PC-AT memory map.

The IBM PC-AT can address up to 16 megabytes (MB) of memory. The normal memory map (shown in Figure E-1) allocates the first 640 kilobytes (KB) of PC-AT memory as user memory. The memory from 1 to 16 MB (which is accessed when running the PC-AT in Protected mode) is called extended memory. Some of the PC-AT memory between 640 KB and 1 MB is used for such purposes as video RAM and ROM to support PC housekeeping functions — but there are large unused areas.

Each Rampage 286 board can contain up to 2 MB of physical memory. Rampage 286 physical memory is divided into 16-KB blocks called *pages*. Rampage 286 software (along with your expanded memory application software) swaps memory pages in and out of open *windows* in the area between 640 KB and 1 MB. To further enhance performance, the AST expanded memory manager can also take advantage of Rampage 286 memory *below* 640 KB. This process — memory paging — allows your PC-AT to access up to 2 MB of Rampage 286 physical memory at RAM speeds, completely transparent to the user.

You can allocate any portion of Rampage 286 memory as conventional/extended memory anywhere on a 128-KB boundary (except for the area between 640 KB and 1 MB) in the 0- to 16-MB PC-AT address space. Whatever Rampage 286 memory is left will be used by the REMM software (if installed) as paged memory.

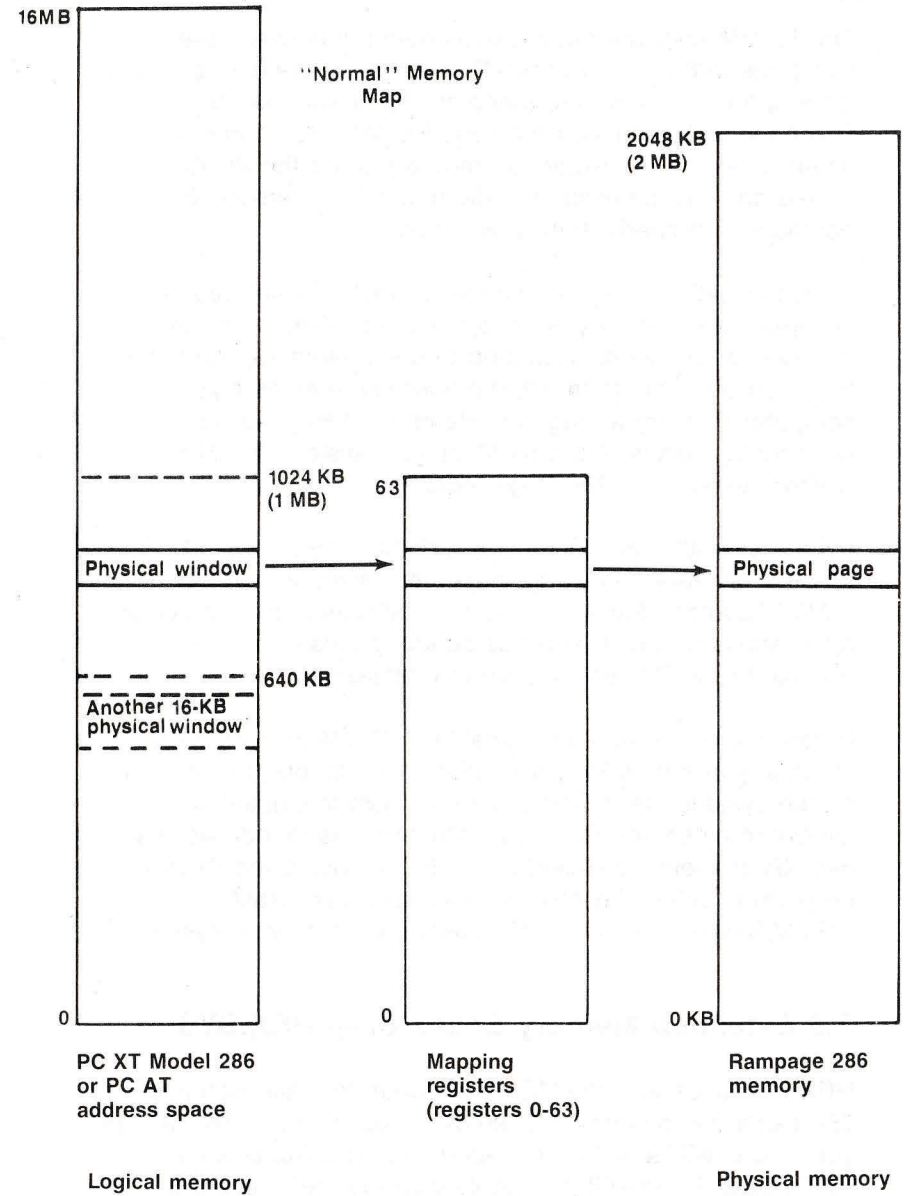

Figure E-1. Paging Technique.

E.2 Expanded Memory Manager — REMM.SYS

The REMM software driver swaps memory between the Rampage 286 board and PC-AT memory by creating pointers, loading the registers, and mapping PC-AT windows to Rampage 286 expanded memory. REMM also conducts an integrity test on the expanded memory when the PC-AT is turned on. This prevents any Rampage 286 memory that is not working properly from being used.

Your application program must keep track of what page of Rampage 286 memory holds a particular element of data, in order to retrieve it. According to parameters supplied by the application program, REMM links windows in logical computer memory to pages of Rampage 286 physical memory by means of the 64 Mapping registers, the Map Control register and the Page registers.

REMM also allocates Rampage 286 memory to several *Process IDs (also known as expanded memory manager (EMM) handles)*. Each Process ID is allocated to a particular applications program, and has certain pages of memory allocated to it. Process IDs aid in multitasking.

Before memory mapping is enabled, REMM automatically maps any of the 16-KB pages that are to fill out the 640 KB on the system board. You can circumvent this automatic allocation by setting Rampage 286 switches to indicate that 640 KB is already installed in the PC-AT. Using the INSTALL program to select the AST memory manager installs REMM.SYS and automatically configures it for your system.

E.3 Extended Memory Emulator — REX.SYS

REX interfaces with the REMM program to make Rampage 286 expanded memory act like extended memory. This allows you to use AST's fASTdisk, SuperDrive, and SuperSpool (also IBM's DOS 3.x VDISK.SYS utility with the "/E" option) to create RAM disks or a print spooler in Rampage 286 expanded memory which emulates extended memory.

This way, you do not have to set Rampage 286 board switches to physically allocate extended memory.

NOTE

REX must be installed after the REMM software, and it cannot function without REMM software.

REX intercepts calls on read-only memory basic input/output system (ROM BIOS) functions designed for extended memory use, and interfaces them to the REMM software so that they can use Rampage 286 expanded memory.

As with applications that use the REMM software, program code portions of the SuperPak programs must reside in the 640 KB of PC-AT memory. However, data associated with SuperPak utilities can use Rampage 286 expanded memory.

E.4 Modifying REMM and REX

As installed with AST's SuperPak INSTALL program, REMM and REX should not require further modification. However, the information in this section is provided as a reference for programmers.

You can add these statements to your CONFIG.SYS file to change the default REMM and REX software drivers:

```
DEVICE=REMM.SYS [/X] [/P] [/S] [/D] [/C] [/N]
```

and/or

```
DEVICE=REX.SYS [nnnn]
```

This section describes the parameters you can use with each of these statements.

E.4.1 DEVICE=REMM.SYS Parameters

You can append multiple parameters to the DEVICE=REMM statement. Separate parameters with one blank space. This section describes the following REMM parameters:

DEVICE=REMM.SYS [/X] [/P] [/S] [/D] [/C] [/N]

With the exception of the "/X" parameter, the following are intended for software developer use.

/X= — Exclude

The /X parameter allows you to exclude certain ranges of memory from REMM mapping. REMM will never map into memory space that is already occupied, but you may have an application for which you would like to reserve certain memory ranges.

NOTE

If you will be using software designed for the enhanced expanded memory specification (EEMS), AST recommends excluding the area used by video memory from mapping.

The INSTALL program automatically installs the appropriate "/X" parameter. (INSTALL excludes the 0B000-0BFFFh range for an IBM monochrome adapter, Hercules graphics adapter, or compatible; 0B800-0BFFFh for an IBM color graphics adapter or compatible; 0A000-0BFFFh for an IBM enhanced graphics adapter or compatible, or for other types of video cards.)

For PC-AT installations, the INSTALL program also automatically excludes memory addresses 0E000-0EFFFh (the area used by the PC-AT extended BIOS).

Format: **/X=nnnn-nnnn**

where *n* is a hexadecimal digit. The first *nnnn* is the starting address of the range, and the second *nnnn* is the ending address.

You can specify multiple ranges as long as you separate each address range with one blank.

Default: None excluded.

Example: **DEVICE=REMM.SYS /X=B000-BFFF**

This is the standard statement for a system that includes a Hercules graphics adapter.

Example: **DEVICE=REMM.SYS /X=C140-CA00
/X=DDDD-DDFF**

Notes: You must leave at least one contiguous 64-KB segment of memory available for mapping by REMM starting in the range C000 through E000. In other words, you may not use the /X parameter to exclude all contiguous 64-KB segments that start in that range.

/PIDS= or /P= — Process IDs

The /P parameter limits the number of process IDs that REMM will allow. A *process ID* is the identification assigned to each user or application on the system.

Format: **/PIDS=n** or **/P=n** (short form)

where *n* is a decimal number from 2 to 256.

Default: The default value is 32.

Example: **DEVICE=REMM.SYS /PIDS=12**

Notes: Increasing the number of process IDs increases the amount of memory used by REMM.

/START= or /S= — Start

The /S parameter tells REMM to put logical page 0 of the mapping window at the specified segment address. This hexadecimal address must be on a 16-KB boundary, and must be within the 0C000-0E000h range.

Format: **/START=nnnn**

where *n* is a hexadecimal digit.

Default: Determined dynamically by REMM.

Example: **DEVICE=REMM.SYS /START=C000**

/DEPTH= or /D= — Depth

The /D parameter specifies the maximum number of mapping register contexts per process ID that REMM can save. Unless you are developing software, the default value should be adequate.

Format: **/DEPTH=nn**

where *nn* is any decimal number from 1 to 32.

Default: The default value is 5.

Example: **DEVICE=REMM.SYS /DEPTH=15**

/CONTEXTS= or /C= — Total Contexts

The /C parameter specifies the total number of mapping register contexts that can be saved for all process IDs combined. Unless you are developing software, the default value should be adequate.

Format: **/CONTEXTS=nnn**

where *n* is a decimal digit.

Default: The value of DEPTH plus the value of PIDS minus one.

Example: **DEVICE=REMM.SYS /CONTEXTS=36**

Notes: The value of CONTEXTS cannot be less than the value of PIDS.

/N — Nomenclature

The /N parameter causes an informational message similar to the following to be displayed at bootup:

```

RAMpage Expanded Memory Manager          Version 3.00
(C) Copyright AST Research, Inc. 1985, 1986    All Rights Reserved.
KB ok  Board at Port  Bank Number .....0123
1152   0268           O=OK, X=Bad or Empty, P=Parity Err..0000
1024   0258           O=OK, X=Bad or Empty, P=Parity Err..00XX

```

```

Expanded Memory Pages:      136
Windows START at:          C000h
Process IDs:                32
Contexts:                   36
Depth:                      5
Mode:                       1F

```

E.4.2 DEVICE=REX.SYS Parameters

The AST SuperPak INSTALL program automatically configures and installs the appropriate command statement for REX.

Format: **DEVICE=REX.SYS [nnnn]**

where *nnnn* is a decimal number indicating the amount of memory (in KB) allocated for use by REX.

Default: The default value is 512 (KB).

Example: **DEVICE=REX.SYS 1024**

Notes: The amount of memory allocated to REX must be at least as much as the sum of all extended memory used by fASTdisk, SuperDrive, SuperSpool, IBM's VDISK, and any other RAM disks and print spoolers set up to use memory outside the 0-to 640-KB area. If you do not express this value as a multiple of 16 KB, it will automatically be rounded up to the next highest multiple.

E.4.3 Modifying CONFIG.SYS for fASTdisk

If you intend to use fASTdisk for virtual disk software, be sure to add the appropriate statement to your CONFIG.SYS file as described in your *AST SuperPak User's Manual*. The `DEVICE=FASTDISK.SYS` statement must follow the `REMM` and `REX` statements in the CONFIG.SYS file to enable fASTdisk to use Rampage 286 memory.

PRODUCT REPAIR PROCEDURE

F

If your AST Research product ever requires repair, contact your dealer first. The dealer from whom you originally purchased the product can usually service the product. If you must return a hardware product to the factory for service, follow these guidelines to ensure rapid, accurate turnaround:

1. *Call AST Research Technical Support for a Return Authorization Number (RAN):* A technician will discuss the problem with you; be prepared to provide the technician with the product model number and serial number. If factory service is required, the technician will give you a Return Authorization Number (RAN). Always refer to the RAN when you return anything for service. AST Research will return anything without a RAN to the sender.
2. *If the product is covered under an AST Research Warranty:* There is no charge for parts or labor involved in the repair. Please include a copy of your original purchase receipt as the proof of date of purchase for all warranty repairs.
3. *If the product is not covered under a warranty:* Contact your dealer or AST Research Technical Support for instructions on obtaining service for your product.
4. *Parts not covered under the warranty:* Dealer- or user-installed parts (such as RAM chips) are not covered under the terms of the warranty. Dealer-installed parts are warranted by the dealer; parts that you install are covered only by the parts suppliers' warranties. If we find that your dealer- or user-installed parts are defective, we can identify

which parts are defective, but we will not replace parts unless you specifically authorize us to do so in writing when you send the board to us. The parts charges and any applicable labor charges will be billed COD.

5. *Describe the problem and return any related accessories:* Please include a brief but explicit written description of the problem when you return your AST product to the factory for repair. Also return any accessories that might relate to the problem. For example, if the the parallel port does not function correctly, be sure to return the parallel port adapter cable with the board.
6. *Be sure to provide a return shipping address that UPS can deliver to and include your RAN:* UPS cannot normally deliver to post office boxes. Reference the RAN issued to you by AST Technical Support on all correspondence. Securely package all materials to prevent shipping damage. Shipping charges must be prepaid; CODs will not be accepted. Ship the materials to the following address:

AST Research, Inc.
Customer Service — RAN xxxx
2722 Michelson Irvine, CA 92715

where xxxx is your assigned
Return Authorization Number.
7. Once your product is repaired, we will return it to you by UPS or UPS Blue Label service, whichever is appropriate for your geographical location. We will return items covered by warranty at our expense. Shipping costs and repair expenses for items not covered by warranty will be billed COD. If you prefer overnight service (UPS Red Label), the shipping charges will be billed COD. If you want us to ship Federal Express, please give us your Federal Express account number for billing purposes.

GLOSSARY

Following are definitions of some technical terms used in this manual:

AUTOEXEC.BAT file

A batch file of Disk Operating System (DOS) commands with the file name AUTOEXEC.BAT that your PC-AT automatically executes when you boot or reboot the computer. The commands in this file are used to install software each time your PC-AT boots up.

For example, if you want to create a SuperDrive random access memory (RAM) disk whenever you are using your PC-AT, you would place the command that creates the SuperDrive in your AUTOEXEC.BAT file. You can use the SuperPak INSTALL program described in Section 4 to create an AUTOEXEC.BAT file to initiate the SuperPak utilities you select.

CONFIG.SYS file

A file of commands used to configure your computer system and install software device drivers. Device drivers are programs that allow your PC-AT to communicate with hardware devices such as the Rampage 286 board. The commands in the CONFIG.SYS file are executed automatically when you boot or reboot your PC- AT, before the AUTOEXEC.BAT file commands.

For example, if you want to use part or all of your Rampage 286 memory as expanded memory, you must place a command in your CONFIG.SYS file to install the Rampage Expanded Memory Manager (REMM) device driver. You can use the SuperPak INSTALL program described in Section 5 to create a CONFIG.SYS file that automatically installs the device drivers needed to use Rampage 286 memory as expanded or linear memory.

Conventional memory

Memory used to fill up PC-AT system memory, up to the maximum of 640 kilobytes (KB) recognized by the DOS.

DESQview

A multitasking/windowing software product that allows you to run several programs concurrently and view them through several windows on your PC-AT display screen.

Device driver

A program that allows your PC-AT to use hardware in your PC-AT system. The REMM and Rampage Extended Memory Emulator (REX) are both device driver programs that allow your PC-AT to use Rampage 286 memory as expanded memory.

Expanded memory

Also called paged memory. Expanded memory is memory provided on the Rampage 286 board that is not allocated as part of PC-AT linear memory. Rather, it is swapped in and out of windows in the PC-AT address space that DOS can recognize, using special software device drivers provided with your Rampage 286. Expanded memory provides maximum performance with new multitasking/windowing software, including DESQview.

Extended memory

Memory at addresses of one megabyte (MB) or greater on the PC-AT. Extended memory is part of linear memory, along with conventional memory. It is also referred to as *protected mode* extended memory (protected mode is explained in the *PC-AT Technical Reference Manual*). Some Rampage 286 expanded memory can *simulate* extended memory with the use of REX software. This extended-paged memory is not actually protected mode memory in the 1-16 MB address range. However, programs designed to use extended memory can use extended-paged memory as well.

Kilobyte (KB)

A unit of measure for memory. KB is an abbreviation for kilobyte. One KB is equal to 1024 bytes of memory.

Linear memory

Linear memory is all the addressable memory in your PC-AT. It includes conventional (0-640 KB) and extended memory (1-16 MB). Linear memory does NOT include paged memory, because paged memory is outside of PC-AT addressable memory.

Megabyte (MB)

A unit of measure for memory. MB is an abbreviation for megabyte. One MB is equal to one thousand kilobytes, and approximately one million bytes, of memory.

Paged memory

Also called expanded memory. Expanded memory is memory provided on the Rampage 286 board that is not allocated as part of PC-AT linear (conventional or extended) memory. Rather, it is swapped in and out of windows in the PC-AT address space that DOS can recognize, using special software device drivers provided with your Rampage 286. Expanded memory provides maximum performance with new multitasking/windowing software, including Lotus 1-2-3 release 2 and DESQview.

Rampage Expanded Memory Manager (REMM)

REMM is a device driver program that enables your PC-AT to use *Rampage!* expanded memory with application programs.

Rampage Extended Memory Emulator (REX)

REX is a device driver program that enables your PC to use *Rampage!* expanded memory with applications that are designed for PC-AT protected mode extended memory.

SETUP Program

A program that you are required to run on the PC-AT when you are adding or removing memory, disk drives, or other system components. Running the SETUP program is part of the procedure for installing your Rampage 286 board. Section 5 provides examples of the SETUP program and what parameters you need to supply to the program.

VDISK

An IBM software product that allows you to create simulated hard disks in random access memory (RAM).

LIMITED WARRANTY

AST Research, Inc. warrants to the original purchaser of this AST Research, Inc. product that it is to be in good working order for a period of 2 years from the date of purchase from AST Research, Inc. or an authorized AST Research, Inc. dealer. Should this product, in AST Research, Inc.'s opinion, malfunction during the warranty period, AST will, at its option, repair or replace it at no charge, provided that the product has not been subjected to misuse, abuse, or non-AST authorized alterations, modifications, and/or repairs.

Products requiring Limited Warranty service during the warranty period should be delivered to AST with proof of purchase. If the delivery is by mail, you agree to insure the product or assume risk of loss or damage in transit. You also agree to prepay shipping charges to AST.

ALL EXPRESS AND IMPLIED WARRANTIES FOR THIS PRODUCT INCLUDING, BUT NOT LIMITED TO, THE WARRANTIES OF MERCHANTABILITY AND FITNESS FOR A PARTICULAR PURPOSE ARE LIMITED IN DURATION TO THE ABOVE 2 YEAR PERIOD. Some states do not allow limitations on how long an implied warranty lasts, so the above limitations may not apply to you.

UNDER NO CIRCUMSTANCES WILL AST RESEARCH, INC. BE LIABLE IN ANY WAY TO THE USER FOR DAMAGES, INCLUDING ANY LOST PROFITS, LOST SAVINGS OR OTHER INCIDENTAL OR CONSEQUENTIAL DAMAGES ARISING OUT OF THE USE OF, OR INABILITY TO USE, SUCH PRODUCT. Some states do not allow the exclusion or limitation of incidental or consequential damages for consumer products, so the above limitations or exclusion may not apply to you. THIS WARRANTY GIVES YOU SPECIFIC LEGAL RIGHTS, AND YOU MAY ALSO HAVE OTHER RIGHTS WHICH MAY VARY FROM STATE TO STATE.

The limited warranty applies to hardware products only.

PRODUCT REPAIR PROCEDURE

If your AST Research product ever requires repair, contact your dealer first. The dealer from whom you originally purchased the product can usually service the product. If you must return a hardware product to the factory for service, follow these guidelines to ensure rapid, accurate turnaround:

1. *Call AST Research Technical Support for a Return Authorization Number (RAN):* A technician will discuss the problem with you. Please supply the technician with model and serial numbers for your AST product.

If factory service is required, the technician will give you a Return Authorization Number (RAN). Always refer to the RAN when you return anything for service. **AST Research will not accept material for repair without a RAN clearly displayed on the outside of the box.**

2. *If the product is covered under an AST Research warranty:* There is no charge for parts or labor involved in the repair. Please include a copy of your original purchase receipt as the proof of date of purchase for all warranty repairs.

If the product is not covered under an AST Research warranty: Contact your dealer or AST Research Technical Support for further information.

3. *Parts not covered under the warranty:* Dealer- or user-installed parts (such as RAM chips) are not covered under the terms of the warranty. Dealer-installed parts are warranted by the dealer; parts that you install are covered only by the parts suppliers' warranties. If we find that your dealer or user-installed parts are defective, we can identify which parts are defective, but we will not replace parts unless you specifically authorize us to do so in

writing when you send the board to us. The parts charges and any applicable labor charges will be billed COD.

4. *Describe the problem and return any related accessories:* Please include a brief but explicit written description of the problem when you return your AST product to the factory for repair. Also return any accessories that might relate to the problem. For example, if the the parallel port does not function correctly, be sure to return the parallel port adapter cable with the board.
5. *Be sure to provide a return shipping address that UPS can deliver to and include your RAN:* UPS cannot deliver to post office boxes. Refer to the RAN issued to you by AST Technical Support on all correspondence. Securely package all materials to prevent shipping damage. Shipping charges must be prepaid; **CODs will not be accepted.** Ship the materials to the following address:

AST Research, Inc.
Customer Support RAN xxxx
19650 Armstrong Ave.
Irvine, CA 92714

where xxxx is your assigned Return Authorization Number.

6. Once your product is repaired, we will return it to you by second-day service, as appropriate for your geographical location. We will return items covered by warranty at our expense. Shipping costs and repair expenses for items not covered by warranty will be billed COD. If you prefer overnight service (UPS Red Label), the shipping charges will be billed COD. If you want us to ship Federal Express, please give us your Federal Express account number for billing purposes.

AST RESEARCH, INC.

Product Comment Form

**Rampage® 286
User's Manual
000432-001 A**

We appreciate your comments regarding any problems or suggestions related to AST Research products. Please use this form to communicate any observations that you have concerning the improvement of either the product itself or the product documentation provided in this manual.

Submitter Information

Submitter's name:

Address:

Product/Manual Comments and Suggestions

Please mail this form to:

AST Research, Inc.
Attn: Product Marketing
2121 Alton Ave.
Irvine, CA 92714-4992

Rampage[®] 286
Enhanced Expanded Memory Board
for the
IBM Personal Computer AT[®]
and XT Model 286
and Other AT-Compatible Computers

Addendum
000432-002 A
January 1988

AST RESEARCH, INC.
Irvine, California
(714) 863-1333

First Edition (January 1988)

AST and Rampage are registered trademarks of AST Research, Inc. Advantage Premium, fASTram, Preview, SuperPak, SuperSpool, and fASTdisk are trademarks of AST Research, Inc.

IBM and AT registered trademarks and Operating System/2 is a trademark of International Business Machines Corporation. DESQview is a trademark of Quarterdeck Office Systems. Concurrent PC DOS XM is a trademark of Digital Research, Inc. Intel is a registered trademark of Intel Corporation. Microsoft is a registered trademark of Microsoft Corporation. Lotus, 1-2-3 and Symphony are registered trademarks of Lotus Development Corporation. FRAMEWORK II is a registered trademark of Ashton-Tate. Paradox is a trademark of Ansa Corporation. SuperCalc is a registered trademark of Computer Associates International, Inc. Hercules is a trademark of Hercules Computer Technology, Inc.

In view of demonstrated product reliability and comprehensive warranty policies, AST Research, Inc. does not normally provide schematics or material lists. AST recognizes that some customers with a large installed base of AST products want supportive documentation for their own service organizations. In such cases, customers should contact AST Research corporate offices to consider an appropriate nondisclosure agreement to obtain this documentation.

Changes are periodically made to the information contained in this manual; these changes will be incorporated into new editions.

A Product Comment Form is provided at the back of this publication. If this form has been removed, please address your comments to: AST Research, Inc., Attn: Product Marketing, 2121 Alton Ave., Irvine, CA 92714. AST Research may use or distribute any of the information you supply in any way it deems appropriate without incurring any obligations whatsoever.

Copyright 1987 AST Research, Inc. All rights are reserved, including those to reproduce this book or parts thereof in any form without permission in writing from AST Research, Inc.

WARNING

This manual is protected by United States Copyright law (Title 17 United States Code). Unauthorized reproduction and/or sales may result in imprisonment of up to one year and fines of up to \$10,000 (17 USC 506). Copyright infringers may be subject to civil liability.

ADDENDUM TO THE RAMPAGE 286 USER'S MANUAL

This addendum updates miscellaneous packaging information and corrects technical details not covered in the current user's manual.

Please replace the original page with new pages from this addendum as follows:

Original Pages

Replacement Pages

| | |
|-------------|-------------|
| iii to viii | iii to viii |
| 1-1 to 1-2 | 1-1 to 1-2 |
| 1-5 to 1-10 | 1-5 to 1-10 |
| 2-1 to 2-14 | 2-1 to 2-14 |
| 3-1 to 3-6 | 3-1 to 3-8 |
| 4-5 to 4-6 | 4-5 to 4-6 |
| A-3 to A-10 | A-3 to A-10 |
| B-1 to B-6 | B-1 to B-2 |
| C-1 to C-4 | C-1 to C-6 |

Please remove the following original pages from the user's manual:

F-1 to F-2

NOTES

THE UNIVERSITY OF MICHIGAN
LIBRARY

ANN ARBOR, MICHIGAN
48106-1000

DATE RECEIVED
BY

DEPARTMENT OF
ECONOMICS

UNIVERSITY OF MICHIGAN
LIBRARY

ANN ARBOR, MICHIGAN
48106-1000

DATE RECEIVED
BY

DEPARTMENT OF
ECONOMICS

UNIVERSITY OF MICHIGAN
LIBRARY

ANN ARBOR, MICHIGAN
48106-1000

DATE RECEIVED
BY

DEPARTMENT OF
ECONOMICS

CONTENTS

| | |
|---|------|
| 1. INTRODUCTION | 1-1 |
| 1.1 Features..... | 1-2 |
| 1.1.1 Hardware Features..... | 1-3 |
| 1.1.2 Software Features..... | 1-4 |
| 1.2 Memory Allocation Example..... | 1-5 |
| 1.3 Getting Started..... | 1-8 |
| 1.4 Checklist..... | 1-10 |
| 1.5 System Requirements..... | 1-10 |
| 1.6 How To Use This Manual..... | 1-11 |
| 1.6.1 Format Notation..... | 1-11 |
| 1.6.2 Related Documentation..... | 1-12 |
| 1.6.3 Manual Outline..... | 1-12 |
| 2. CONFIGURING YOUR RAMPAGE 286 BOARD | 2-1 |
| 2.1 Default Configuration..... | 2-1 |
| 2.2 Basic Configuration..... | 2-4 |
| 2.2.1 What You Need to Know Before You Start..... | 2-4 |
| 2.2.2 SW1 Location and Default Settings..... | 2-7 |
| 2.2.3 Conventional/Extended Memory Size Setting (SW1-1 through SW1-4)..... | 2-8 |
| 2.2.4 Base I/O Address Settings (SW1-5 through SW1-8)..... | 2-10 |
| 2.2.5 Dual Page Mode (SW1-9)..... | 2-11 |
| 2.2.6 SW2 Location and Default Settings..... | 2-12 |
| 2.2.7 Conventional/Extended Memory Installed (SW2-1 through SW2-7)..... | 2-13 |

CONTENTS

| | |
|--|------------|
| 2.2.8 Parity Checking (SW2-8)..... | 2-14 |
| 3. INSTALLING RAMPAGE 286 IN YOUR COMPUTER | 3-1 |
| 3.1 Opening Your Computer..... | 3-1 |
| 3.2 Disabling System Board Memory | 3-4 |
| 3.3 Installing Rampage 286 in Your Computer..... | 3-6 |
| 4. RUNNING SETUP | 4-1 |
| 4.1 SETUP Examples..... | 4-5 |
| 5. INSTALLING RAMPAGE 286 SOFTWARE..... | 5-1 |
| 5.1 Example SuperPak Configuration..... | 5-3 |
| 5.2 Starting the INSTALL Program..... | 5-4 |
| 5.3 Installing Options..... | 5-8 |
| 5.4 Save the Installation..... | 5-9 |
| A. SWITCH SETTING SUMMARY..... | A-1 |
| A.1 Rampage 286 Conventional/Extended Memory Size | A-1 |
| A.2 Base I/O Address | A-4 |
| A.3 Dual Page Mode..... | A-6 |
| A.4 Conventional/Extended Memory Already Installed..... | A-7 |
| A.5 Parity Checking..... | A-10 |
| B. MEMORY ALLOCATION FOR EEMS SOFTWARE | B-1 |

| | |
|--|------------|
| C. ADDING OR REMOVING MEMORY | C-1 |
| C.1 Valid Memory Configurations | C-1 |
| C.2 Memory Chip Specifications..... | C-2 |
| C.3 Rules for Handling Memory Chips | C-2 |
| C.4 Installing Additional Memory | C-4 |
| D. ADVANCED INSTALL PROCEDURES | D-1 |
| D.1 Using INSTALL..... | D-3 |
| D.2 Running the INSTALL Program..... | D-5 |
| D.3 Installing SuperPak Software for Another Computer | D-6 |
| D.4 INSTALL Main Menu | D-8 |
| D.5 Installing fASTdisk..... | D-9 |
| D.6 Installing SuperDrive..... | D-12 |
| D.7 Installing the AST Expanded Memory Manager | D-15 |
| D.8 Installing SuperSpool..... | D-17 |
| D.9 Saving the Installation..... | D-18 |
| D.10 Example of Completed Installation | D-20 |
| E. HOW RAMPAGE 286 WORKS..... | E-1 |
| E.1 Memory Paging..... | E-1 |
| E.2 Expanded Memory Manager -- REMM.SYS..... | E-4 |
| E.3 Extended Memory Emulator -- REX.SYS | E-4 |

CONTENTS

| | |
|--|------|
| E.4 Modifying REMM and REX..... | E-5 |
| E.4.1 DEVICE = REMM.SYS Parameters..... | E-7 |
| E.4.2 DEVICE = REX.SYS Parameters..... | E-9 |
| E.4.3 Modifying CONFIG.SYS for fASTdisk..... | E-10 |

| | |
|-----------------------|------------|
| GLOSSARY | Glossary-1 |
|-----------------------|------------|

FIGURES

| | |
|---|------|
| Figure 1-1. Example Memory Map..... | 1-7 |
| Figure 2-1. Rampage 286 Board Layout..... | 2-2 |
| Figure 2-2. Rampage 286 Switch SW1 (Default Setting)..... | 2-7 |
| Figure 2-3. Rampage 286 Switch SW2 (Default Setting)..... | 2-12 |
| Figure 3-1. Removing the PC XT Model 286 Cover..... | 3-2 |
| Figure 3-2. Removing the PC AT Cover..... | 3-3 |
| Figure 3-3. Setting the PC AT System Board Jumper..... | 3-5 |
| Figure 3-4. Installing the Rampage 286 Board..... | 3-7 |
| Figure 5-1. Initial INSTALL Screen..... | 5-5 |
| Figure 5-2. Main INSTALL Menu..... | 5-7 |
| Figure A-1. Rampage 286 Conventional/Extended Memory Size..... | A-3 |
| Figure A-2. Rampage 286 Base I/O Address Settings..... | A-5 |
| Figure A-3. Dual Page Mode Configuration..... | A-6 |
| Figure A-4. Conventional/Extended Memory Already Installed . | A-8 |
| Figure A-5. Parity Error Checking..... | A-10 |
| Figure C-1. Rampage 286 Memory Configuration..... | C-1 |
| Figure C-2. Installing Rampage 286 Memory Chips..... | C-3 |
| Figure D-1. Main INSTALL Menu..... | D-8 |
| Figure D-2. INSTALL with fASTdisk Edit Box..... | D-11 |
| Figure D-3. INSTALL with SuperDrive Edit Box..... | D-14 |
| Figure D-4. INSTALL with SuperSpool Edit Box..... | D-17 |
| Figure E-1. Paging Technique..... | E-3 |

TABLES

NOTES

| | |
|---|------|
| Table 2-1. Rampage 286 Default Configuration..... | 2-3 |
| Table 2-2. Rampage 286 Conventional/Extended Memory Size..... | 2-9 |
| Table 2-3. Rampage 286 Base I/O Address..... | 2-10 |
| Table C-1. Compatible 256-KB Memory Chips..... | C-2 |

NOTES

1. The first part of the book is devoted to the study of the theory of the differential equations of the first order. The second part is devoted to the study of the theory of the differential equations of the second order. The third part is devoted to the study of the theory of the differential equations of the third order. The fourth part is devoted to the study of the theory of the differential equations of the fourth order. The fifth part is devoted to the study of the theory of the differential equations of the fifth order. The sixth part is devoted to the study of the theory of the differential equations of the sixth order. The seventh part is devoted to the study of the theory of the differential equations of the seventh order. The eighth part is devoted to the study of the theory of the differential equations of the eighth order. The ninth part is devoted to the study of the theory of the differential equations of the ninth order. The tenth part is devoted to the study of the theory of the differential equations of the tenth order.

Rampage[®] 286 is a flexible and powerful memory enhancement board. It represents a new generation of products to expand the available memory for the IBM Personal Computer XT (PC XT) Model 286, PC AT[®], and compatible computers. Rampage 286 offers these features:

- *Conventional memory.* Computer memory from 0 to 640 kilobytes (KB) is called conventional memory.
Your computer's system board contains a certain amount of conventional memory, and add-on boards (such as Rampage 286) can provide additional conventional memory. No matter how much memory you install in your computer, you can never have more than 640 KB of conventional memory. The Disk Operating System (DOS) can directly use all the conventional memory installed in your computer.
- *Extended memory.* Memory in the 1- to 16-megabyte (MB) address range is called extended memory. (Extended and conventional memory are also called *linear* or *non-paged* memory.)

Extended memory is used by the 80286 microprocessor when it operates in protected mode. (The *Technical Reference Manual* for your computer provides further information on protected mode.) Extended memory is used by the Operating System/2[™] (OS/2) and XENIX[™] operating systems, random access memory (RAM) disks and print spoolers. However, current versions of DOS and most application programs cannot use extended memory directly.

- *Expanded memory.* Memory above 640-KB that is made available by swapping segments of RAM in and out of conventional memory is called expanded or paged memory. Rampage 286 expanded memory supports expanded memory specification (EMS) software, including Lotus® 1-2-3 Release 2 and Symphony® 1.1. These applications use expanded memory by working with AST's expanded memory manager software, which is supplied with your Rampage 286 board.

Rampage 286 also supports the enhanced expanded memory specification (EEMS), providing superior performance with software written to support it, including Microsoft® Windows 2.0 and Quarterdeck DESQview™.

AST expanded memory software allows your computer to access up to 8 MB of memory (using four 2-MB AST expanded memory boards, including Rampage 286 and Advantage Premium™), while maintaining DOS compatibility.

NOTE

To ensure compatibility, use only AST expanded memory products (such as Advantage Premium) with Rampage 286.

- *Full compatibility with the Lotus/Intel/Microsoft (LIM) version 3.2 Expanded Memory Specification (EMS).* In addition, AST's EEMS offers a more flexible paging scheme that maximizes software performance and exceeds the capabilities of the LIM EMS.

1.1 Features

Rampage 286 hardware and software features are described in this section.

- *SuperSpool™*, an intelligent print spooler that allows you to send files to a printer while freeing your computer for other tasks.
- *INSTALL*, a software installation utility that allows easy installation of the fASTdisk, SuperDrive, SuperSpool, and expanded memory software.

NOTE

You must use a version 6.10 (or later) SuperPak diskette with Rampage 286. All your SuperPak software is fully compatible with earlier versions of AST products.

1.2 Memory Allocation Example

A typical example of how Rampage 286 memory can be allocated is presented in this section. Suppose your computer has 512 KB of conventional memory installed and your Rampage 286 provides 2 MB of RAM. You would like to use Rampage 286 to do the following:

- Fill out conventional memory to 640 KB.
- Allocate extended memory to create a 384-KB fASTdisk.
- Use all remaining Rampage 286 memory as expanded memory for use with EMS or EEMS application programs.

Set Rampage 286 for 512 KB of conventional/extended memory already installed in your computer and allocate 512 KB of Rampage 286 memory as conventional/extended memory, -- 128 KB are used to round out conventional memory and 384 KB as extended memory. The remaining 1536 KB (1.5 MB) of Rampage 286 memory would be used as expanded memory.

Memory addressed between 640 and 1024 KB, called *high memory*, is reserved for video graphics adapters and other DOS utilities. This memory comes from the read only memory basic input/output system (ROM BIOS), display adapter, disk controller, and other peripheral devices in your computer. Rampage 286 uses a portion of high memory for paging expanded memory. High memory is not counted as part of conventional or extended memory.

Figure 1-1 shows how the different types of memory are used in the computer. In this example, your computer has a total of 2560 KB including 512 KB on the system board, 2048 KB on the Rampage 286 board, and 384 KB of reserved memory. When you start the computer, it counts only the total conventional and extended memory. Therefore, you will see 1024 KB in the upper-left corner of the screen when you boot the computer (640 KB conventional memory plus 384 KB extended memory).

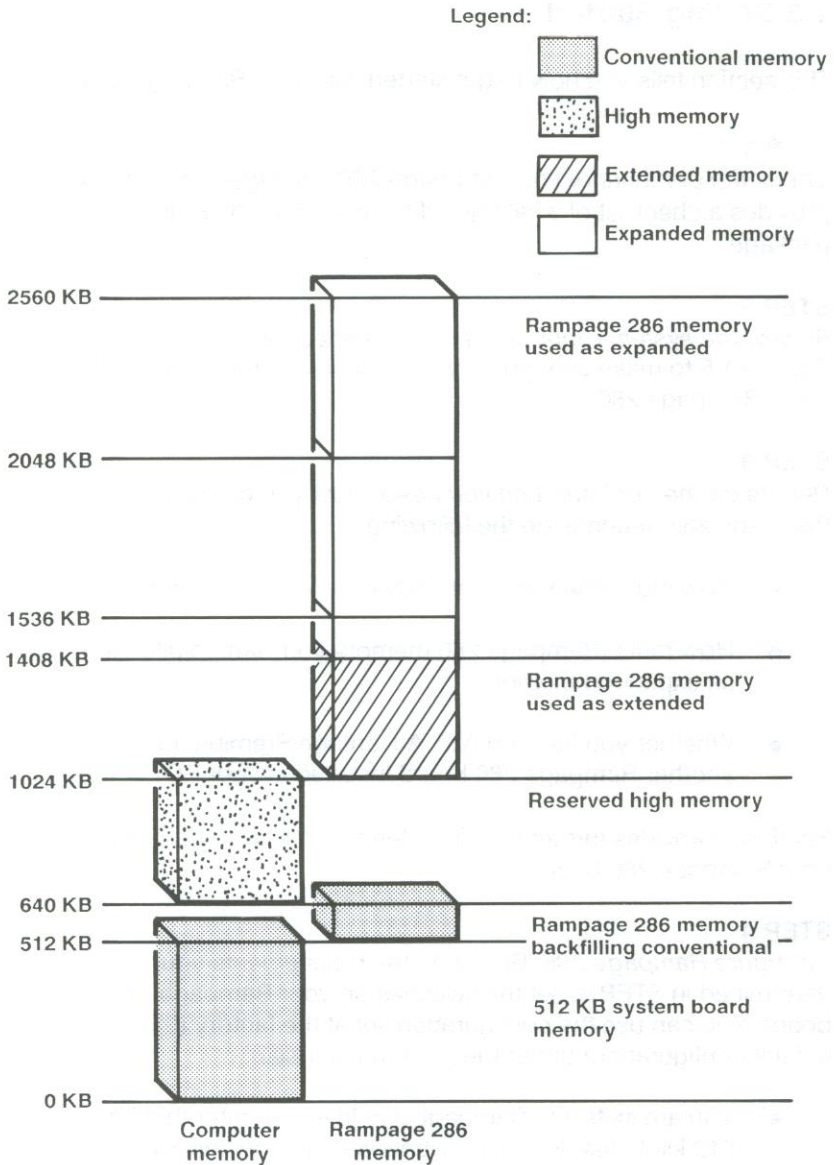

Figure 1-1. Total Memory.

1.3 Getting Started

This section tells you how to get started with your Rampage 286.

STEP 1

Check the contents of your Rampage 286 package. Section 1.4 provides a checklist of what should be included with your package.

STEP 2

Review the system requirements for Rampage 286. Read Section 1.5 to make sure your system meets the requirements for using Rampage 286.

STEP 3

Decide on the configuration you need. How you configure Rampage 286 depends on the following:

- How much memory is already installed in your computer.
- How much Rampage 286 memory you want to allocate as expanded memory.
- Whether you have an AST Advantage Premium or another Rampage 286 board installed in your PC.

Section 2 provides further help in determining how to configure your Rampage 286 board.

STEP 4

Configure Rampage 286. Based on the requirements you determined in STEP 3, set the switches on your Rampage 286 board. You can use the configuration set at the factory (the default configuration) under these circumstances:

- You are installing Rampage 286 in a computer that has 512 kilobytes (KB) of conventional memory installed.
- No other expanded memory board is installed in your system.

If the default configuration does not meet your needs, reconfigure the board as shown in Section 2.

STEP 5

Configure the PC AT system board. To improve the performance of EEMS software, you may disable part of the system board's memory and backfill it with Rampage 286 memory. This procedure gives the EEMS software more conventional memory to use for paging. See Section 3 for instructions on setting the system board's jumper or switch block for the amount of memory.

STEP 6

Install Rampage 286. Once the Rampage 286 board is configured, you must install it in your PC. Follow the instructions in Section 3.

STEP 7

Run the SETUP program. Whenever you change your memory configuration, and you plan to add a SuperDrive RAM disk drive, you need to run the SETUP program provided with your computer. Section 4 gives examples of what parameters you should supply while you are running SETUP.

STEP 8

Install the Rampage 286 software. Section 5 shows you how to use INSTALL to configure and install the Rampage 286 software.

STEP 9

Start your application software package. Rampage 286 is compatible with EMS and EEMS software. Follow the instructions provided with your software to install and use it.

1.4 Checklist

In addition to this user's manual (AST part number 000432-001), your Rampage 286 package includes the following items:

- Rampage 286 full-size expanded memory board.
- SuperPak diskette (version 6.10 or later).
- *SuperPak User's Manual* (000300-001).

1.5 System Requirements

The minimum hardware requirements using Rampage 286 is an AT-compatible computer with at least one floppy drive, an unused dual-connector expansion slot, and a bus speed of 8 megahertz (MHz) or less. (See your computer's user manual for the bus speed.) Compatible computers include the IBM PC XT Model 286, PC AT, and other computers with AT-equivalent expansion buses.

Rampage 286 will also run in a PC XT (or compatible) with the AST's Xformer/286™ replacement system board with a bus speed of 10 MHz (requires Rampage 286 version 02A or later).

Rampage 286 is compatible with DOS 2.0, or later, or OS/2 on machines that support it.

This section gives a step-by-step procedure for configuring the Rampage 286 board. It provides the information you need to configure your board in most circumstances.

Section 2.1 shows the Rampage 286 default configuration (how the board is configured at the factory). If the default configuration meets your needs, you can skip directly to Section 3.

If you need to change any of the settings, Section 2.2 leads you step-by-step through each switch and jumper setting.

2.1 Default Configuration

Rampage 286 is shipped from the factory in this configuration:

- Your computer has 512 KB of conventional memory already installed.
- Rampage 286 uses 128 KB to backfill conventional memory. The rest of the Rampage 286 memory is used as expanded.
- Multitasking is enabled.
- The base I/O address is 0218h.

If the default settings are appropriate for your system, you can skip directly to Section 3, with no further configuration. Figure 2-1 shows the default configuration which is explained in Table 2-1.

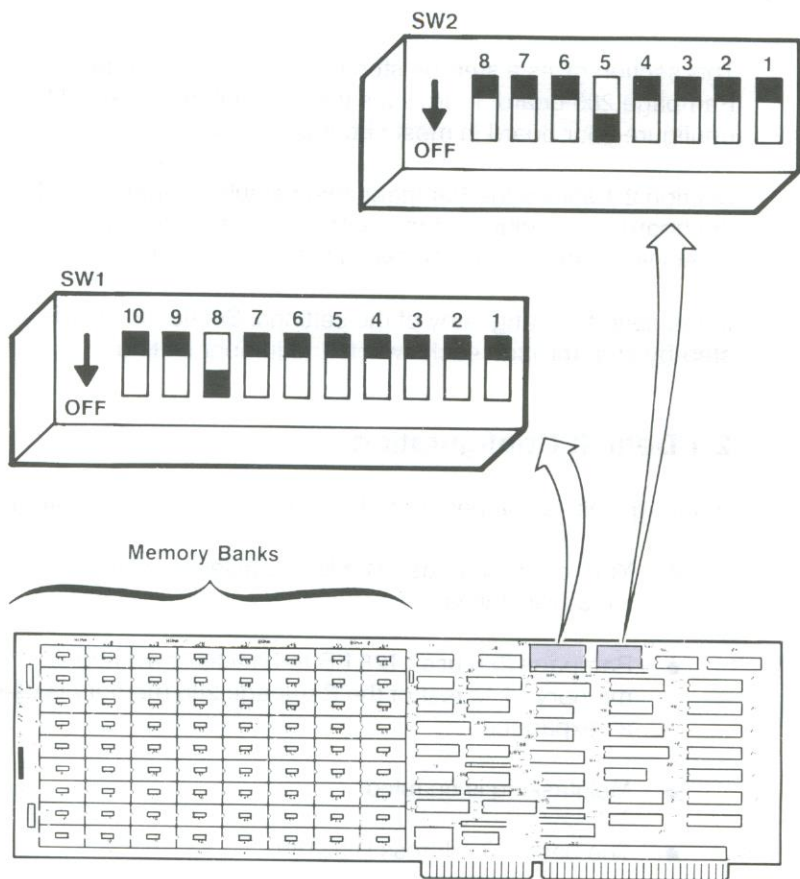

Figure 2-1. Rampage 286 Board Layout.

Table 2-1. Rampage 286 Default Configuration.

| Parameter | Default | Comments |
|---|---|---|
| <i>Expanded Memory Parameters</i> | | |
| Rampage 286 conventional/extended memory size | 128 KB (SW1-1 ON SW1-2 ON SW1-3 ON SW1-4 ON) | The amount of Rampage 286 memory that can be allocated as conventional or extended memory. Remaining Rampage 286 memory is used as expanded memory. |
| Base I/O address | 0218h (SW1-5 ON SW1-6 ON SW1-7 ON SW1-8 OFF) | Rampage 286 uses the I/O address to communicate with the computer, allowing it to use expanded memory. Do <i>not</i> change this parameter unless you are installing more than one Rampage 286 board in your system, or another device (such as an Advantage Premium) in your PC uses the same I/O address range. |
| Dual Page mode | Enabled (SW1-9 ON) | Ensures proper multitasking operation (allows two sets of Mapping registers to be used). |
| <i>Conventional/Extended Memory Configuration</i> | | |
| Conventional/extended memory already installed | 512 KB (SW2-1 ON SW2-2 ON SW2-3 ON SW2-4 ON SW2-5 OFF SW2-6 ON SW2-7 ON) | Change this setting if your computer has other than 512 KB of conventional memory already installed or if you want to address additional Rampage 286 memory below 640 KB to enhance multitasking. |
| Parity checking | Enabled (SW2-8 ON) | Parity checking enables memory error checking. To ensure reliability, do not disable. |

2.2 Basic Configuration

This section tells you what you need to know before you configure Rampage 286, then guides you step-by-step through each switch setting on the board.

2.2.1 What You Need to Know Before You Start

Before you change the configuration of your Rampage 286 board, you need to answer the following questions.

A. Are there any other expanded memory boards installed in your computer?

If your computer includes any other AST expanded memory boards (for example, AST's Advantage Premium board), make sure their base I/O and memory addresses do not conflict. Use only AST expanded memory boards together with Rampage 286 in the same machine.

B. How much conventional/extended memory is already installed in your computer?

One of the Rampage 286 switch settings is the total amount of conventional and extended memory already installed in your computer. Memory between 0 and 640 KB is called *conventional* memory. Memory in the range from 1 megabyte (MB) to 16 MB is called *extended memory*. (The range from 640 KB to 1 MB is called *high memory*. Portions of memory in this range are reserved for video display buffer memory and other DOS housekeeping functions.)

If you are not sure how much conventional/extended memory is installed in your computer, boot the computer and note the total amount of memory displayed in the upper-left corner of the screen. This total shown includes memory on the system and other memory boards.

You will need to separate total linear memory into conventional and extended memory when you run the SETUP program after your Rampage 286 is installed. Subtract 640 KB from your total linear memory. Any remainder is extended memory. If your total linear memory is less than 640 KB, it is all conventional.

C. How much Rampage 286 memory do you want to allocate as conventional memory?

If your computer has less than 640 KB of conventional memory installed, allocate enough Rampage 286 memory to round out your conventional memory to 640 KB.

To determine how much Rampage 286 memory to allocate as conventional memory, note the amount of memory displayed when booting the computer. If more than 640 KB is displayed, you already have a full 640 KB of conventional memory.

D. How much Rampage 286 memory do you want to allocate as extended memory?

- Extended memory is linear memory from 1 to 16 MB.
- Most application programs are not able to use extended memory. If you plan to use RAM disks, print spoolers, XENIX, or Operating System/2™ (OS/2), you may use the Rampage 286 board switches to allocate extended memory.

If you want to use extended memory only for RAM disks (AST's SuperDrive and fASTdisk) or AST's SuperSpool print spooler program, the SuperPak INSTALL program will automatically allocate Rampage 286 expanded memory as emulated extended memory. That way, you need not worry about setting your Rampage 286 hardware switches to allocate Rampage 286 memory as extended memory.

E. How much Rampage 286 memory do you want to allocate as conventional/extended memory?

Add your totals from D and E together to get the total Rampage 286 memory that you want to allocate as conventional and extended memory. One of your Rampage 286 switch settings is set according to this total.

The following sections take you step-by-step through the configuration of the two switches on your Rampage 286 board.

2.2.2 SW1 Location and Default Settings

Figure 2-2 shows the location and default setting for SW1.

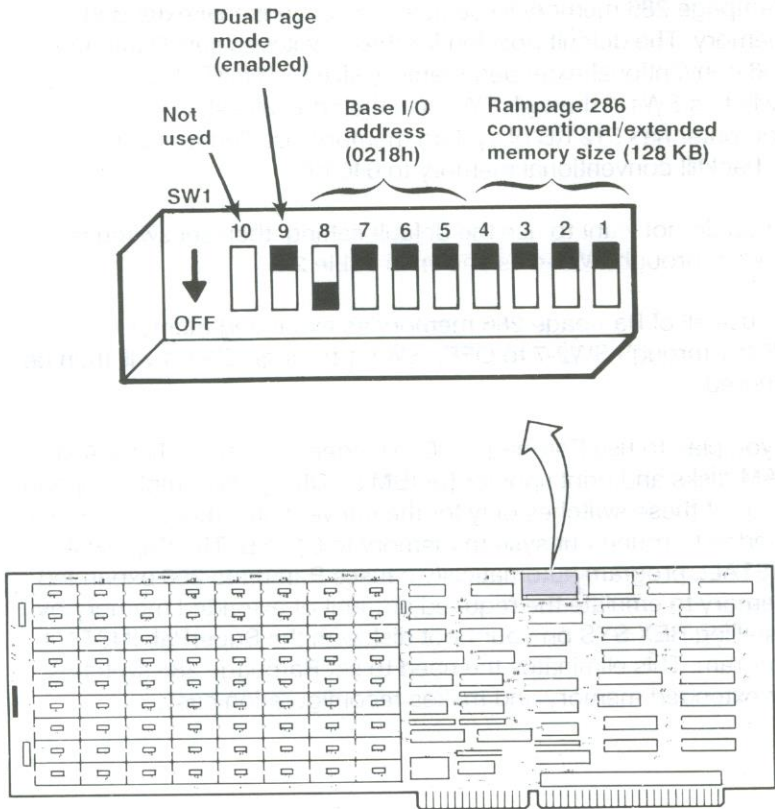

Figure 2-2. Rampage 286 Switch SW1 (Default Setting).

2.2.3 Conventional/Extended Memory Size Setting (SW1-1 through SW1-4)

Switches SW1-1 through SW1-4 determine the amount of Rampage 286 memory to be used as conventional/extended memory. The default position for these switches sets Rampage 286 conventional/extended memory size to 128 KB. Leave switches SW1-1 through SW1-4 in their default settings if your computer has 512 KB of system memory installed and you want to backfill conventional memory to 640 KB.

If you do not want to use the default setting, then set switches SW1-1 through SW1-4 as shown in Table 2-2.

To use all of Rampage 286 memory as expanded memory, set SW2-1 through SW2-7 to OFF. SW1-1 through SW1-4 will then be ignored.

If you plan to use Rampage 286 extended memory only for AST RAM disks and print spooler (or IBM's VDISK), the simplest option is to set these switches only for the conventional memory amount needed to round out system memory to 640 KB. The SuperPak INSTALL program automatically causes Rampage 286 expanded memory to emulate the required amount of extended memory by installing REX.SYS on your boot disk with the SuperPak INSTALL program. This eliminates the need to set Rampage 286 switches for extended memory and makes reconfiguration easy.

Table 2-2. Rampage 286 Conventional/Extended Memory Size.

| Rampage 286 Conventional/Extended Memory Size * | SW1-1 | SW1-2 | SW1-3 | SW1-4 |
|--|--------------|--------------|--------------|--------------|
| ** 128 KB | ON | ON | ON | ON |
| 256 KB | ON | ON | ON | OFF |
| 384 KB | ON | ON | OFF | ON |
| 512 KB | ON | ON | OFF | OFF |
| 640 KB | ON | OFF | ON | ON |
| 768 KB | ON | OFF | ON | OFF |
| 896 KB | ON | OFF | OFF | ON |
| 1024 KB | ON | OFF | OFF | OFF |
| 1152 KB | OFF | ON | ON | ON |
| 1280 KB | OFF | ON | ON | OFF |
| 1408 KB | OFF | ON | OFF | ON |
| 1536 KB | OFF | ON | OFF | OFF |
| 1664 KB | OFF | OFF | ON | ON |
| 1792 KB | OFF | OFF | ON | OFF |
| 1920 KB | OFF | OFF | OFF | ON |
| 2048 KB | OFF | OFF | OFF | OFF |

* These settings are ignored if all Rampage 286 memory is to be used as expanded memory (SW2-1 through SW2-7 OFF).

** Default setting.

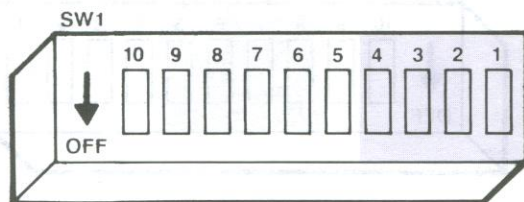

2.2.4 Base I/O Address Settings (SW1-5 through SW1-8)

Switches SW1-5 through SW1-8 determine the base I/O address. The default position for these switches sets the Rampage 286 base I/O address to 0218h. Leave SW1-5 through SW1-8 in the default positions unless you have another board in your computer with base I/O address 0218h.

If you have another expanded memory board in your computer (such as another Rampage 286 or an Advantage Premium), or another device with a conflicting I/O address, configure Rampage 286 to use a different base I/O address (Table 2-3 summarizes the possible base I/O addresses).

Table 2-3. Rampage 286 Base I/O Address.

| Base I/O Address | SW1-5 | SW1-6 | SW1-7 | SW1-8 |
|------------------|-------|-------|-------|-------|
| 0208 | ON | ON | ON | ON |
| *0218 | ON | ON | ON | OFF |
| 0258 | ON | OFF | ON | OFF |
| 0268 | ON | OFF | OFF | ON |
| 02A8 | OFF | ON | OFF | ON |
| 02B8 | OFF | ON | OFF | OFF |
| 02E8 | OFF | OFF | OFF | ON |

*Default setting

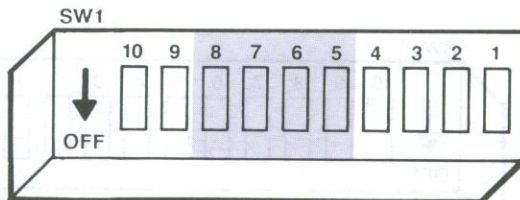

NOTE

When you select base I/O address 02x8h, Rampage 286 uses the following addresses:

02x8h, 42x8h, 82x8h, C2x8h,
02x9h, 42x9h, 82x9h, C2x9h

For example, selecting base I/O address 0208h causes the Rampage 286 board to use I/O addresses 0208h, 4208h, 8208h, C208h, 0209h, 4209h, 8209h, and C209h.

2.2.5 Dual Page Mode (SW1-9)

Switch position SW1-9 selects Dual Page mode which enables Rampage 286 to run several operations at once (called *multitasking*). Turn switch SW1-9 on to enable Dual Page mode. Under normal conditions, SW1-9 should be left on.

NOTE

Switch SW1-10 is not used. It can be left on or off.

2.2.6 SW2 Location and Default Settings

Figure 2-3 shows the location and default setting for SW2.

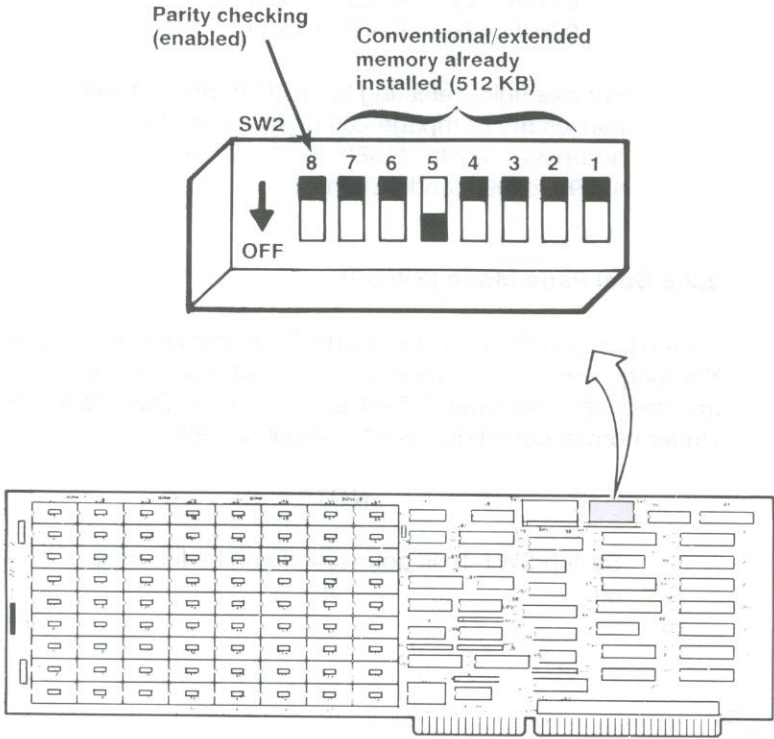

Figure 2-3. Rampage 286 Switch SW2 (Default Setting).

2.2.7 Conventional/Extended Memory Installed (SW2-1 through SW2-7)

The amount of conventional/extended memory already installed in your computer before adding Rampage 286 determines how you should set switch positions SW2-1 through SW2-7.

Leave switches SW2-1 through SW2-7 in their default setting if your computer has 512 KB already installed.

To use all of Rampage 286 memory as expanded memory, turn off switches SW2-1 through SW2-7.

Appendix A gives all the switch settings for this parameter.

2.2.8 Parity Checking (SW2-8)

Switch position SW2-8 enables or disables parity checking. By default, SW2-8 is ON, enabling parity checking. Leave SW2-8 on unless you have a special reason to disable parity checking. Only under rare circumstances would you change this setting.

NOTES

1. The Rampage 286 board is designed to be used with the following hardware configurations:

2. The Rampage 286 board is designed to be used with the following software configurations:

3. The Rampage 286 board is designed to be used with the following software configurations:

4. The Rampage 286 board is designed to be used with the following software configurations:

5. The Rampage 286 board is designed to be used with the following software configurations:

6. The Rampage 286 board is designed to be used with the following software configurations:

7. The Rampage 286 board is designed to be used with the following software configurations:

INSTALLING RAMPAGE 286 IN YOUR COMPUTER

This section provides installation instructions, including:

- Preparing your computer for installing Rampage 286 (Section 3.1).
- Installing the board in your computer (Section 3.2).

3.1 Opening Your Computer

This section tells you how to set up your computer before installing Rampage 286.

CAUTION

Be sure that the power switch is off and the power cord is removed from the wall outlet. Turn off any other equipment connected to the computer. Installing any component while the power is on can permanently damage your computer and its components.

You will need a flathead screwdriver or nut driver to perform the following procedure.

Depending on the type of computer you have, follow these instructions to remove the cover. (For more information, see your computer's user manual.)

PC XT Model 286: Use a flathead screwdriver or nut driver to remove the cover mounting screws from the rear panel of the computer. Once you have removed the cover mounting screws, pull the cover off as shown in Figure 3-1.

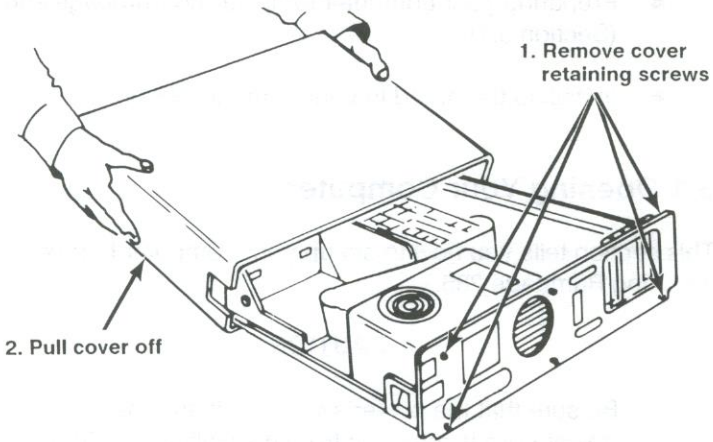

Figure 3-1. Removing the PC XT Model 286 Cover.

PC AT: Unlock the key lock at the front of the PC AT by turning the key counterclockwise. Remove the back panel (attached with plastic fastener strips) from the rear of the computer. Use a flathead screwdriver or nut driver to remove the cover mounting screws. Slide the cover toward the front until it comes off, as shown in Figure 3-2.

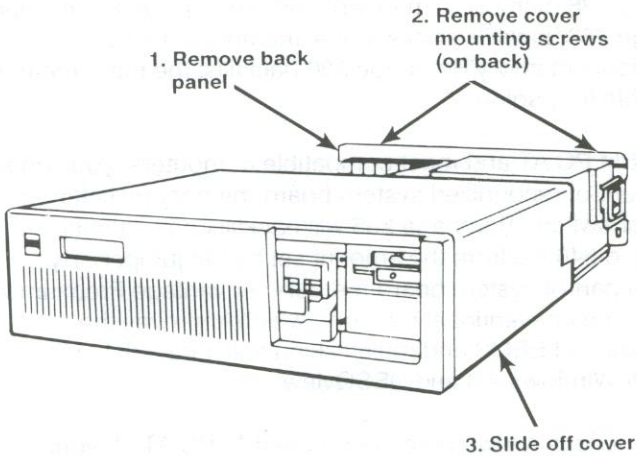

Figure 3-2. Removing the PC AT Cover.

3.2 Disabling System Board Memory

You can enhance the performance of EEMS software by disabling all or part of the system board memory and using Rampage 286 to backfill conventional memory.

Paging takes place in conventional memory. System board memory is not mapped, so it cannot be used for paging. Rampage 286 memory is mapped, and paging can occur where Rampage 286 backfills conventional memory. The more conventional memory Rampage 286 backfills, the more memory is available for paging.

On the IBM PC AT and most compatible computers, you can set the amount of recognized system board memory by setting a jumper or switch. Rampage 286 will backfill conventional memory to 640 KB from the amount set by the jumper. By disabling part of system board memory, Advantage Premium will backfill more conventional memory, which improves the performance of EEMS and multitasking software, such as Microsoft Windows 2.0 and DESQview.

The instructions shown here are for the IBM PC AT. If your computer is configured differently, see the computer's user manual for instructions.

While the computer cover is off, follow these steps to set the jumper:

STEP 1

Lift the disk controller board: To reach the jumper, you need to remove the disk controller board. Remove the disk controller board's bracket retaining screw and save it. Carefully lift the board about two inches. Be careful not to pull on the ribbon cables attached to the board.

STEP 2

Set the jumper: Locate jumper J18 toward the front of the computer. Set the jumper for the appropriate amount of memory, either 256 KB or 512 KB.

If you have 512 KB of memory on the system board, you may leave the jumper in the 512 KB position, or set it to 256 KB to backfill. If you have 256 KB on the system board, leave the jumper in the 256 KB position. Do not set it for 512 KB. (See Figure 3-3.)

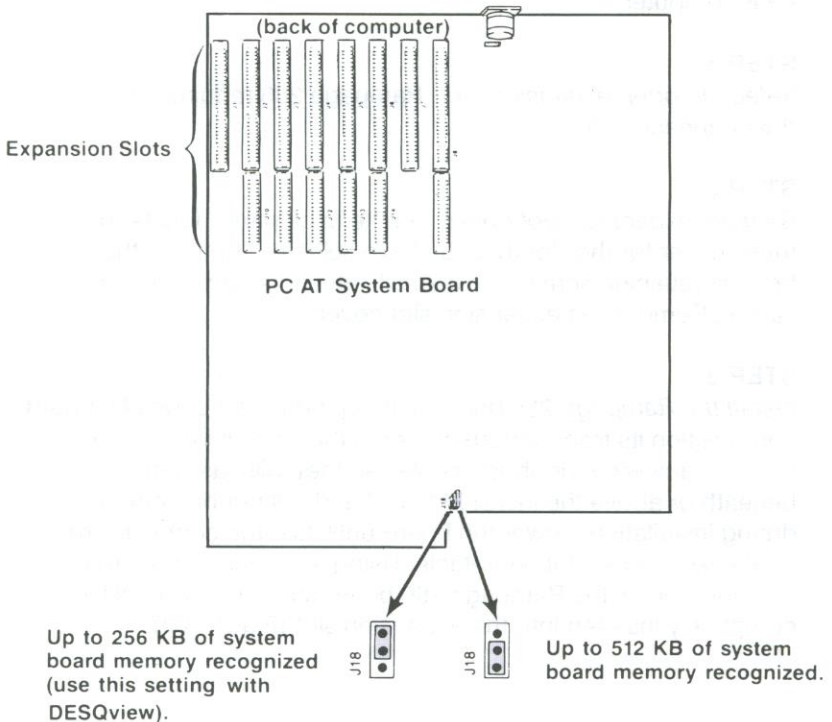

Figure 3-3. Setting the PC AT System Board Jumper.

CAUTION

Do not remove memory chips from the PC AT system board, regardless of the jumper setting.

STEP 3

Replace the disk controller board: Carefully press down on the disk controller board until it is completely inserted into the slot. Be sure all ribbon cables are securely attached. Replace the bracket retaining screw you removed earlier.

3.3 Installing Rampage 286 in Your Computer

This section tells you how to install the Rampage 286 board into your computer.

STEP 1

Select an open expansion slot: Rampage 286 requires one dual-connector slot.

STEP 2

Remove expansion slot cover: On the back panel, locate the metal cover for the slot that you have selected. Remove the bracket retaining screw with a small flathead screwdriver and save it. Remove the expansion slot cover.

STEP 3

Install the Rampage 286 board: Line up your Rampage 286 board and position its front bottom corner in the card guide channel. Position any wires or ribbon cables so they will pass either beneath or above the installed board and will not be damaged during installation. Lower the board until its edge connector rests on the expansion slot receptacle. Using an evenly distributed pressure, press the Rampage 286 board straight down until it is completely inserted into the expansion slot (Figure 3-4).

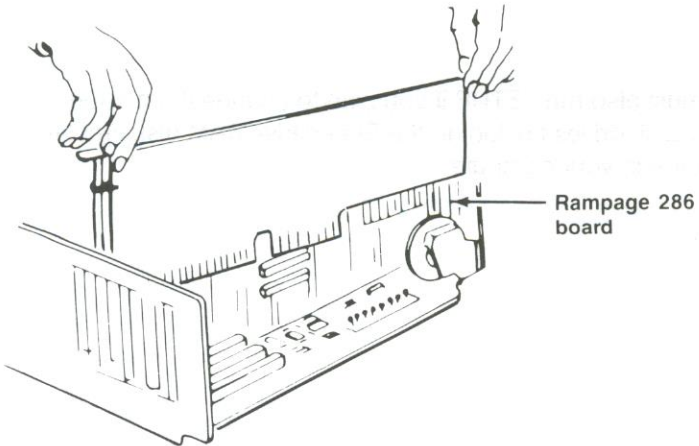

Figure 3-4. Installing the Rampage 286 Board.

STEP 4

Secure the board to the rear of the chassis: Use the screw you removed from the expansion slot cover in Step 2.

STEP 5

Replace the cover: Carefully slide the cover from the front until it stops securely against the rear panel. Reinstall the cover mounting screws you removed earlier.

If you have a PC AT, press the back panel so that the plastic fastener strips secure it in place.

STEP 6

Install cables: Replace the power cord to the system unit and be sure that the keyboard and the monitor connectors are plugged in. Reattach any other cables and connectors you removed previously.

Now you are ready to start the computer. Run the SETUP program whenever you add or subtract conventional or extended memory from your computer. The SETUP program is included on the diagnostics diskette that comes with your computer. Section 5 gives several examples of how to run the SETUP program.

You must also run SETUP if you plan to change the number of floppy disk drives (including the SuperDrive RAM disk emulation program) in your computer.

Enter the amount of memory installed above 1 MB (the amount does not necessarily have to be expressed in 512-KB increments, as implied in the display above). Press < **Enter** > to proceed with SETUP.

STEP 6

Verify that all SETUP options are set correctly: SETUP will then display the options for disk type, memory size, and adapter type. If all options are correct, press **Y** to reboot.

4.1 SETUP Examples

This section gives several sample Rampage 286 configurations and provides the appropriate SETUP parameters.

Example 1: Your PC AT has 256 KB of conventional memory installed, and you have a 512-KB Rampage 286 board. You want to use 384 KB of Rampage 286 memory to fill out conventional memory to 640 KB, and you want to allocate 128 KB as extended memory (memory addressed above 1 MB). Specify the following:

Base memory size: 640

Extended memory size: 128

Example 2: Your IBM PC XT with the Xformer/286 system board replacement has 512 KB of conventional memory installed, and you have a 512-KB Rampage 286 board. You want to use 128 KB of Rampage 286 memory to fill out conventional memory to 640 KB, and you want to allocate 384 KB as extended memory. Specify the following:

Base memory size: 640

Extended memory size: 384

Example 3: Your PC XT Model 286 has 512 KB of conventional memory installed, and you have a 2-MB Rampage 286 board. You want to use 128 KB of Rampage 286 memory to fill out

conventional memory to 640 KB, and you want to allocate all remaining memory (1920 KB) as expanded memory. Specify the following:

Base memory size: 640
Extended memory size: 0

Example 4: Your PC AT has 512 KB of conventional memory installed, and you have a 2-MB Rampage 286 board. You want to use 128 KB of Rampage 286 memory to fill out conventional memory to 640 KB, 384 KB as extended memory, and all remaining memory (1536 KB, 2048 minus 128 minus 384) as expanded memory. Specify the following:

Base memory size: 640
Extended memory size: 384

Example 5: Your PC AT has 256 KB of conventional memory installed, and you have one 2-MB Rampage 286 board and one 2-MB Advantage Premium board. You want to use 384 KB of Rampage 286 memory to fill out conventional memory to 640 KB, 1 MB as expanded (paged) memory, and all remaining memory (2688 KB) as extended memory (memory addressed above 1 MB). Specify the following:

Base memory size: 640
Extended memory size: 2688

Enhanced Expanded Memory Specification software works best when as much Rampage 286 memory as possible is allocated as conventional memory.

If you have a PC AT, it is possible to allocate as much as 384 KB of Rampage 286 memory as conventional memory.

If you have a PC XT Model 286 with 512 KB installed, you can allocate up to 128 KB of Rampage 286 memory as conventional memory. If your PC XT Model 286 has 640 KB installed, do not allocate any Rampage 286 memory as conventional memory.

| <i>Rampage 286</i> Conventional/Extended Memory Size | SW1-1 | SW1-2 | SW1-3 | SW1-4 |
|--|-------|-------|-------|-------|
| * 128 KB | ON | ON | ON | ON |
| 256 KB | ON | ON | ON | OFF |
| 384 KB | ON | ON | OFF | ON |
| 512 KB | ON | ON | OFF | OFF |
| 640 KB | ON | OFF | ON | ON |
| 768 KB | ON | OFF | ON | OFF |
| 896 KB | ON | OFF | OFF | ON |
| 1024 KB | ON | OFF | OFF | OFF |
| 1152 KB | OFF | ON | ON | ON |
| 1280 KB | OFF | ON | ON | OFF |
| 1408 KB | OFF | ON | OFF | ON |
| 1536 KB | OFF | ON | OFF | OFF |
| 1664 KB | OFF | OFF | ON | ON |
| 1792 KB | OFF | OFF | ON | OFF |
| 1920 KB | OFF | OFF | OFF | ON |
| 2048 KB | OFF | OFF | OFF | OFF |

* Default setting.

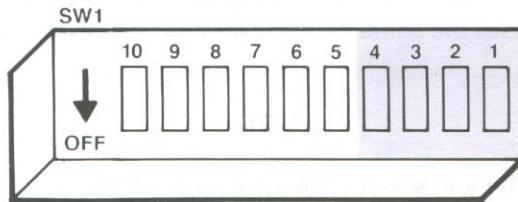

Figure A-1. Rampage 286 Conventional/Extended Memory Size.

NOTE

If Rampage 286 is configured for all of its memory to be used as expanded memory (for example, switches SW2-1 through SW2-7 OFF) the above linear memory size settings will be ignored.

You can use the REX.SYS program to configure Rampage 286 expanded memory as extended memory without resetting Rampage 286 hardware switches. However, the reverse is not true: you cannot override the setting for conventional/extended memory size to allocate extended memory as expanded memory.

To reconfigure Rampage 286 expanded memory as extended memory without resetting board switches, use the INSTALL program (described in Section 4) to add or modify the DEVICE = REX.SYS statement in your CONFIG.SYS file.

A.2 Base I/O Address

Figure A-2 shows the Rampage 286 base I/O address settings. This setting defines the base I/O address used by Rampage 286 to communicate with the computer so that it can make use of expanded memory.

If more than one AST expanded memory board is installed in a computer, each must use a different base I/O address. To prevent I/O address conflicts, make sure that no other devices in the computer uses the same base I/O address or associated I/O addresses.

NOTE

When you select base I/O address 02x8h, Rampage 286 uses these associated addresses:

02x8h, 42x8h, 82x8h, C2x8h,
02x9h, 42x9h, 82x9h, C2x9h

For example, selecting base I/O address 0208h causes the Rampage 286 board to use I/O addresses 0208h, 4208h, 8208h, C208h, 0209h, 4209h, 8209h, and C209h.

| Base I/O Address | SW1-5 | SW1-6 | SW1-7 | SW1-8 |
|------------------|-------|-------|-------|-------|
| 0208h | ON | ON | ON | ON |
| * 0218h | ON | ON | ON | OFF |
| 0258h | ON | OFF | ON | OFF |
| 0268h | ON | OFF | OFF | ON |
| 02A8h | OFF | ON | OFF | ON |
| 02B8h | OFF | ON | OFF | OFF |
| 02E8h | OFF | OFF | OFF | ON |

* Default setting

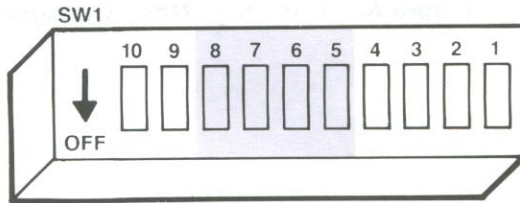

Figure A-2. Rampage 286 Base I/O Address Settings.

A.3 Dual Page Mode

Figure A-3 shows how to enable or disable Dual Page mode. Dual Page mode allows expanded memory to maintain two sets of mapping registers, which ensures proper multitasking operation. Generally, Dual Page mode is left enabled.

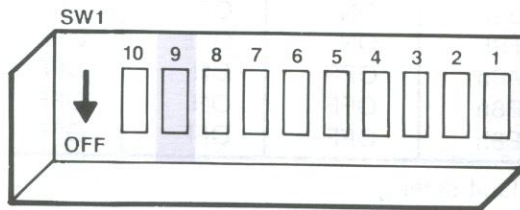

Figure A-3. Dual Page Mode Configuration.

A.4 Conventional/Extended Memory Already Installed

Figure A-4 shows the possible Rampage 286 settings for conventional/extended (linear) memory already installed. This setting tells Rampage 286 how much conventional and extended memory is already installed in your computer, and prevents parity errors.

Please note that this parameter does not include the high memory between 640 KB and 1 MB. For example, if your computer includes 640 KB of conventional memory and 128 KB of extended memory, the setting for conventional/extended (linear) memory already installed is 768 KB (SW2-1 through SW2-4 ON, SW2-5 through SW2-7 OFF).

NOTE

To allocate all Rampage 286 memory as expanded (paged) memory, simply set the conventional/extended memory already installed to 16 MB (SW2-1 through SW2-7 all OFF). If this is done, the settings for switches SW1-1 through SW1-4 are ignored.

Switch Setting Summary

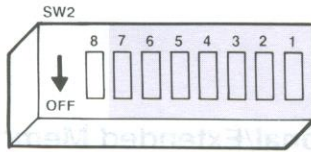

| Memory Already Installed | SW2-1 | SW2-2 | SW2-3 | SW2-4 | SW2-5 | SW2-6 | SW2-7 |
|--------------------------|-------|-------|-------|-------|-------|-------|-------|
| 0 KB | ON | ON | ON | ON | ON | ON | ON |
| 128 KB | ON | ON | ON | ON | ON | ON | OFF |
| 256 KB | ON | ON | ON | ON | ON | OFF | ON |
| 384 KB | ON | ON | ON | ON | ON | OFF | OFF |
| 512 KB * | ON | ON | ON | ON | OFF | ON | ON |
| 640 KB | ON | ON | ON | ON | OFF | ON | OFF |
| 768 KB | ON | ON | ON | ON | OFF | OFF | ON |
| 896 KB | ON | ON | ON | ON | OFF | OFF | OFF |
| 1024 KB | ON | ON | ON | OFF | ON | ON | ON |
| 1152 KB | ON | ON | ON | OFF | ON | ON | OFF |
| 1280 KB | ON | ON | ON | OFF | ON | OFF | ON |
| 1408 KB | ON | ON | ON | OFF | ON | OFF | OFF |
| 1536 KB | ON | ON | ON | OFF | OFF | ON | ON |
| 1664 KB | ON | ON | ON | OFF | OFF | ON | OFF |
| 1792 KB | ON | ON | ON | OFF | OFF | OFF | ON |
| 1920 KB | ON | ON | ON | OFF | OFF | OFF | OFF |
| 2048 KB | ON | ON | OFF | ON | ON | ON | ON |
| 2176 KB | ON | ON | OFF | ON | ON | ON | OFF |
| 2304 KB | ON | ON | OFF | ON | ON | OFF | ON |
| 2432 KB | ON | ON | OFF | ON | ON | OFF | OFF |
| 2560 KB | ON | ON | OFF | ON | OFF | ON | ON |
| 2688 KB | ON | ON | OFF | ON | OFF | ON | OFF |
| 2816 KB | ON | ON | OFF | ON | OFF | OFF | ON |
| 2994 KB | ON | ON | OFF | ON | OFF | OFF | OFF |
| 3072 KB | ON | ON | OFF | OFF | ON | ON | ON |
| 3200 KB | ON | ON | OFF | OFF | ON | ON | OFF |
| 3328 KB | ON | ON | OFF | OFF | ON | OFF | ON |
| 3456 KB | ON | ON | OFF | OFF | ON | OFF | OFF |
| 3584 KB | ON | ON | OFF | OFF | OFF | ON | ON |
| 3712 KB | ON | ON | OFF | OFF | OFF | ON | OFF |
| 3840 KB | ON | ON | OFF | OFF | OFF | OFF | ON |
| 3968 KB | ON | ON | OFF | OFF | OFF | OFF | OFF |
| 4096 KB | ON | OFF | ON | ON | ON | ON | ON |
| 4224 KB | ON | OFF | ON | ON | ON | ON | OFF |
| 4352 KB | ON | OFF | ON | ON | ON | OFF | ON |
| 4480 KB | ON | OFF | ON | ON | ON | OFF | OFF |
| 4608 KB | ON | OFF | ON | ON | OFF | ON | ON |
| 4736 KB | ON | OFF | ON | ON | OFF | ON | OFF |
| 4864 KB | ON | OFF | ON | ON | OFF | OFF | ON |
| 4992 KB | ON | OFF | ON | ON | OFF | OFF | OFF |
| 5120 KB | ON | OFF | ON | OFF | ON | ON | ON |
| 5248 KB | ON | OFF | ON | OFF | ON | ON | OFF |
| 5376 KB | ON | OFF | ON | OFF | ON | OFF | ON |
| 5504 KB | ON | OFF | ON | OFF | ON | OFF | OFF |
| 5632 KB | ON | OFF | ON | OFF | OFF | ON | ON |
| 5760 KB | ON | OFF | ON | OFF | OFF | ON | OFF |
| 5888 KB | ON | OFF | ON | OFF | OFF | ON | ON |
| 6016 KB | ON | OFF | ON | OFF | OFF | OFF | ON |
| 6144 KB | ON | OFF | OFF | ON | OFF | ON | OFF |
| 6272 KB | ON | OFF | OFF | ON | ON | ON | ON |
| 6400 KB | ON | OFF | OFF | ON | ON | ON | OFF |
| 6528 KB | ON | OFF | OFF | ON | ON | OFF | ON |
| 6656 KB | ON | OFF | OFF | ON | OFF | ON | OFF |
| 6784 KB | ON | OFF | OFF | ON | OFF | ON | ON |
| 6912 KB | ON | OFF | OFF | ON | OFF | ON | OFF |
| 7040 KB | ON | OFF | OFF | ON | OFF | OFF | ON |
| 7168 KB | ON | OFF | OFF | OFF | ON | OFF | OFF |
| 7296 KB | ON | OFF | OFF | OFF | ON | ON | ON |
| 7424 KB | ON | OFF | OFF | OFF | ON | ON | OFF |
| 7552 KB | ON | OFF | OFF | OFF | ON | OFF | ON |
| 7680 KB | ON | OFF | OFF | OFF | OFF | OFF | OFF |
| 7808 KB | ON | OFF | OFF | OFF | OFF | ON | ON |
| 7936 KB | ON | OFF | OFF | OFF | OFF | ON | OFF |
| 8064 KB | ON | OFF | OFF | OFF | OFF | OFF | ON |

* Default setting

Figure A-4. Conventional/Extended Memory Already Installed.

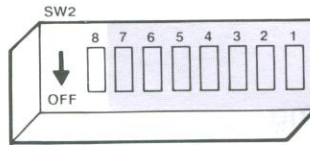

| Memory Already Installed | SW2-1 | SW2-2 | SW2-3 | SW2-4 | SW2-5 | SW2-6 | SW2-7 |
|--------------------------|-------|-------|-------|-------|-------|-------|-------|
| 8192 KB | OFF | ON | ON | ON | ON | ON | ON |
| 8320 KB | OFF | ON | ON | ON | ON | ON | OFF |
| 8448 KB | OFF | ON | ON | ON | ON | OFF | ON |
| 8576 KB | OFF | ON | ON | ON | ON | OFF | OFF |
| 8704 KB | OFF | ON | ON | ON | OFF | ON | ON |
| 8832 KB | OFF | ON | ON | ON | OFF | ON | OFF |
| 8960 KB | OFF | ON | ON | ON | OFF | OFF | ON |
| 9088 KB | OFF | ON | ON | ON | OFF | OFF | OFF |
| 9216 KB | OFF | ON | ON | OFF | ON | ON | ON |
| 9344 KB | OFF | ON | ON | OFF | ON | ON | OFF |
| 9472 KB | OFF | ON | ON | OFF | ON | OFF | OFF |
| 9600 KB | OFF | ON | ON | OFF | OFF | ON | ON |
| 9728 KB | OFF | ON | ON | OFF | OFF | ON | OFF |
| 9856 KB | OFF | ON | ON | OFF | OFF | OFF | ON |
| 9984 KB | OFF | ON | ON | OFF | OFF | OFF | OFF |
| 10112 KB | OFF | ON | ON | OFF | OFF | ON | ON |
| 10240 KB | OFF | ON | OFF | ON | ON | ON | OFF |
| 10368 KB | OFF | ON | OFF | ON | ON | OFF | ON |
| 10496 KB | OFF | ON | OFF | ON | ON | OFF | OFF |
| 10624 KB | OFF | ON | OFF | ON | OFF | ON | ON |
| 10752 KB | OFF | ON | OFF | ON | OFF | ON | OFF |
| 10880 KB | OFF | ON | OFF | ON | OFF | OFF | ON |
| 11008 KB | OFF | ON | OFF | ON | OFF | OFF | OFF |
| 11136 KB | OFF | ON | OFF | ON | OFF | ON | ON |
| 11264 KB | OFF | ON | OFF | OFF | ON | ON | OFF |
| 11392 KB | OFF | ON | OFF | OFF | ON | OFF | ON |
| 11520 KB | OFF | ON | OFF | OFF | ON | OFF | OFF |
| 11648 KB | OFF | ON | OFF | OFF | OFF | ON | ON |
| 11776 KB | OFF | ON | OFF | OFF | OFF | ON | OFF |
| 11904 KB | OFF | ON | OFF | OFF | OFF | OFF | ON |
| 12032 KB | OFF | ON | OFF | OFF | OFF | OFF | OFF |
| 12160 KB | OFF | ON | OFF | ON | ON | ON | ON |
| 12288 KB | OFF | OFF | ON | ON | ON | ON | OFF |
| 12416 KB | OFF | OFF | ON | ON | ON | OFF | ON |
| 12544 KB | OFF | OFF | ON | ON | ON | OFF | OFF |
| 12672 KB | OFF | OFF | ON | ON | OFF | ON | ON |
| 12800 KB | OFF | OFF | ON | ON | OFF | ON | OFF |
| 12928 KB | OFF | OFF | ON | ON | OFF | OFF | ON |
| 13056 KB | OFF | OFF | ON | ON | OFF | OFF | OFF |
| 13184 KB | OFF | OFF | ON | ON | OFF | OFF | ON |
| 13312 KB | OFF | OFF | ON | OFF | ON | ON | OFF |
| 13340 KB | OFF | OFF | ON | OFF | ON | ON | OFF |
| 13568 KB | OFF | OFF | ON | OFF | ON | OFF | ON |
| 13696 KB | OFF | OFF | ON | OFF | ON | OFF | OFF |
| 13824 KB | OFF | OFF | ON | OFF | OFF | ON | ON |
| 13952 KB | OFF | OFF | ON | OFF | OFF | ON | OFF |
| 14080 KB | OFF | OFF | ON | OFF | OFF | OFF | ON |
| 14208 KB | OFF | OFF | ON | OFF | OFF | OFF | OFF |
| 14366 KB | OFF | OFF | OFF | ON | ON | ON | ON |
| 14464 KB | OFF | OFF | OFF | ON | ON | ON | OFF |
| 14592 KB | OFF | OFF | OFF | ON | ON | OFF | ON |
| 14720 KB | OFF | OFF | OFF | ON | ON | OFF | OFF |
| 14848 KB | OFF | OFF | OFF | ON | OFF | ON | ON |
| 14976 KB | OFF | OFF | OFF | ON | OFF | ON | OFF |
| 15104 KB | OFF | OFF | OFF | ON | OFF | OFF | ON |
| 15232 KB | OFF | OFF | OFF | ON | OFF | OFF | OFF |
| 15360 KB | OFF | OFF | OFF | OFF | ON | ON | ON |
| 15488 KB | OFF | OFF | OFF | OFF | ON | ON | OFF |
| 15616 KB | OFF | OFF | OFF | OFF | ON | OFF | ON |
| 15744 KB | OFF | OFF | OFF | OFF | ON | OFF | OFF |
| 15872 KB | OFF | OFF | OFF | OFF | OFF | ON | ON |
| All RAMpage memory paged | OFF | OFF | OFF | OFF | OFF | ON | OFF |
| | OFF | OFF | OFF | OFF | OFF | OFF | ON |
| | OFF | OFF | OFF | OFF | OFF | OFF | OFF |

Figure A-4 (Continued).

A.5 Parity Checking

Figure A-5 shows how to enable or disable parity error checking. To ensure the most reliable memory operation, leave parity checking enabled.

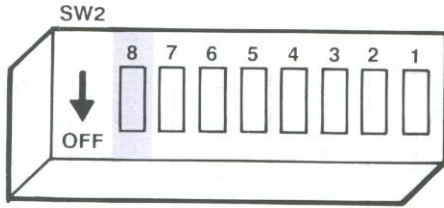

Figure A-5. Parity Error Checking.

MEMORY ALLOCATION FOR EEMS SOFTWARE

NOTES
B

For best performance with EEMS software, you may disable all or part of the system board's memory. For more instructions, see Section 3. See your EEMS application's user manual for specific memory requirements.

NOTES

ADDING OR REMOVING MEMORY

C

This section tells you how to install additional memory on Rampage 286. You can increase Rampage 286 memory to 2 megabytes (MB) by installing 256-kilobyte (KB) dynamic random access memory (DRAM) chips.

C.1 Valid Memory Configurations

You must add or subtract Rampage 286 memory in 0.5 MB (512-KB) increments. The possible memory configurations are 0.5 MB, 1 MB, 1.5 MB, and 2 MB.

Figure C-1 shows the memory configurations.

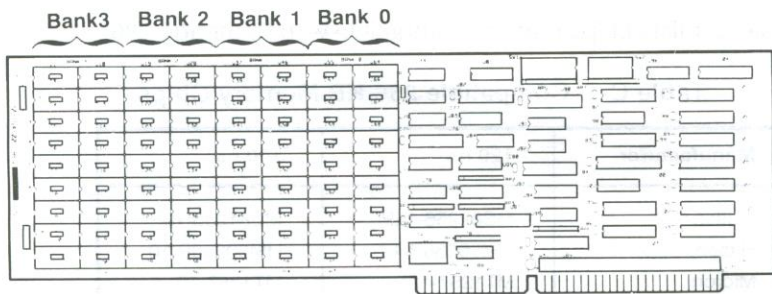

| Amount of RAM | Install RAM in these banks |
|---------------|----------------------------|
| 512 KB | 0 |
| 1 MB | 0, 1 |
| 1.5 MB | 0, 1, 2 |
| 2 MB | 0, 1, 2, 3 |

Figure C-1. Rampage 286 Memory Configuration.

C.2 Memory Chip Specifications

Rampage 286 requires 256-KB DRAM chips which meet these specifications:

- Pin 1 not used.
- + 5 Volt only.

Depending on your computer, select SIMMs of these speeds:

- *For the IBM PC XT Model 286 and AT-compatible computers with 8 megahertz (MHz) bus speeds:* 120 nanoseconds (ns) or faster.
- *For the XT-compatible computers with the AST Xformer/286 replacement system board:* 100 ns or faster.

Table C-1 lists chips that are compatible with Rampage 286.

Table C-1. Compatible 256-KB Memory Chips.

| Manufacturer | 120 ns | 100 ns |
|-------------------|--------------|--------------|
| Fujitsu | MB81256-12P | MB81256-10P |
| Hitachi | HM50256P-12 | HM50256P-10 |
| Micron | MT1257-12 | MT1257-10 |
| Motorola | MCM6256P-12 | MCM6256P-10 |
| NEC | UPD41256C-12 | UPD41256C-10 |
| Samsung | KM41256-12 | KM41256-10 |
| Texas Instruments | TMS4256-12NL | TMS4256-10NL |
| Toshiba | TMM41256P-12 | TMM41256P-10 |

C.3 Rules for Handling Memory Chips

Before you start installing chips into your Rampage 286 board, there are a few rules of which you must be aware. Following

these rules will prevent damage to your Rampage 286 board and computer:

- Use chips that meet the specifications in Section C.2.
- Fill each bank with the same type of memory chip. You cannot mix 256-KB DRAMs with other chips in the same bank.
- Add or subtract Rampage 286 memory in 512-KB increments, as shown in Section C.1.
- Before handling any chips, discharge any static electricity on your body by touching a grounded surface such as the computer chassis.
- Insert each chip so the notch or pin 1 indicator points left (See Figure C-2.)

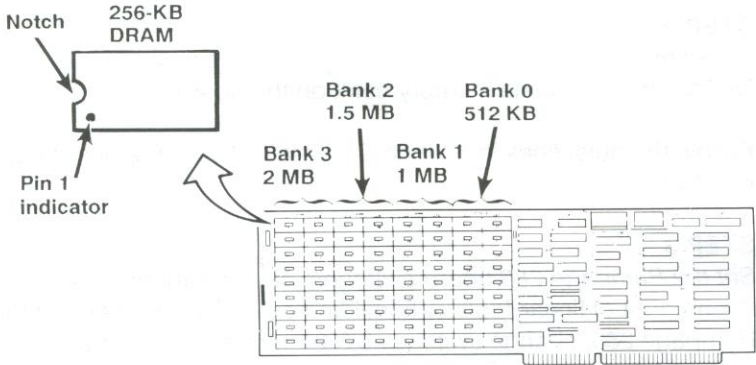

Figure C-2. Installing Rampage 286 Memory Chips.

- Be careful not to bend the chip's pins. If a chip seems too wide to fit in its socket, place it on its side on a flat surface and gently angle it under both thumbs to bend the legs inward.

- Remove a chip by prying it loose with a flathead screwdriver or chip extractor. Be careful not to damage the chip pins.
- You must run the SETUP and INSTALL programs whenever you add or remove Rampage 286 memory. Section 4 tells you how to run SETUP. For instructions on using INSTALL, see Section 5.

C.4 Installing Additional Memory

Follow this procedure to install DRAM chips on your Rampage 286 board:

STEP 1

Remove the Rampage 286 board: Shut off the power to the computer and remove the Rampage 286 board.

STEP 2

Install memory chips: Install each bank of eighteen 256-KB DRAM chips in the next empty bank on the board.

Follow the guidelines in Section C.3 to install your memory chips carefully.

STEP 3

Set the Rampage 286 board switches: If you want to increase the amount of linear (conventional and extended) memory on the Rampage 286, change switches SW1-1 through 1-4 to the appropriate settings. See Section 2 for instructions.

STEP 4

Reinstall the Rampage 286 board: Follow the instructions in Section 3 to install the Rampage 286 in your computer.

STEP 5

Run the SETUP program: You must run SETUP whenever you change the amount of linear memory in your computer. See Section 4 for instructions.

STEP 6

Run the INSTALL program: To change the amount of expanded memory, or the size of the SuperPak utilities, run the INSTALL program as shown in Section 5.

NOTES

1. The memory modules are installed in the DIMM sockets on the system board. The system board is located in the system unit. The system unit is located in the system rack. The system rack is located in the system cabinet. The system cabinet is located in the system room. The system room is located in the system building. The system building is located in the system city. The system city is located in the system state. The system state is located in the system country. The system country is located in the system world.

2. The memory modules are installed in the DIMM sockets on the system board. The system board is located in the system unit. The system unit is located in the system rack. The system rack is located in the system cabinet. The system cabinet is located in the system room. The system room is located in the system building. The system building is located in the system city. The system city is located in the system state. The system state is located in the system country. The system country is located in the system world.

)

)

)

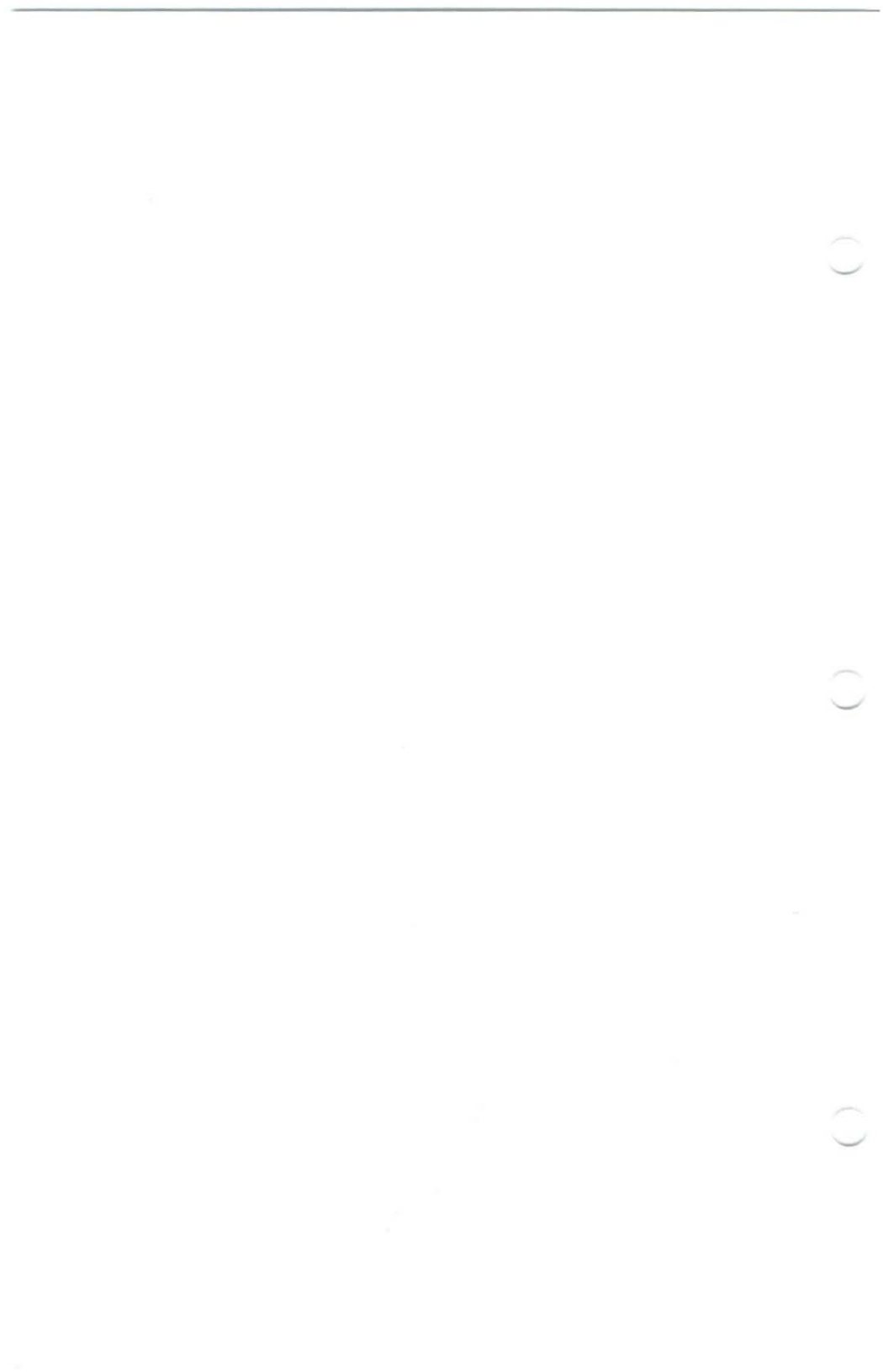

1

2

3

(

(

(



