

# PEER-2030

20MHz 386SX™ SYSTEM



# PEER-2030

---

**Personal Computer**

**User's Manual**

**Edition 1.2**

The following does not apply to any country where such provisions are inconsistent with local law:

We make no warranties with respect to this documentation either express or implied and provides it "as is". This includes but is not limited to any implied warranties of merchantability and fitness for a particular purpose. The information in this document is subject to change without notice. We assume no responsibility for any errors that may appear in this document.

IBM PC, IBM PC/XT and IBM PC/AT are registered trademarks of International Business Machines Corporation. MS-DOS is a registered trademark of Microsoft Corporation. Intel is a registered trademark of Intel Corporation. The typeface used in the text of this manual is Helvetica and is used under licence from the Allied Corporation, the owner of the typeface.

All other brand names are registered trademarks of their respective companies

The PEER-2030, this manual and all illustrations in it are copyrighted with all rights reserved. Under the copyright laws, the PEER-2030, this manual, and the illustrations, may not be copied without the written consent of Datatech Enterprises Co., Ltd.

Documentation design and writing by: Echo Chen, Patty Lee, Hazel Chen, and Alan Patterson.

© 1991 Datatech Enterprises Co., Ltd.

## **Federal Communications Commission (FCC) Statement**

---

### ***Radio Frequency Interference Statement***

This equipment has been tested and found to comply with the limits for a Class B digital device, pursuant to Part 15 of the FCC Rules. These limits are designed to provide reasonable protection against harmful interference in a residential installation. This equipment generates, uses and can radiate radio frequency energy and if not installed and used in accordance with the instructions, may cause harmful interference to radio communications. However, there is no guarantee that interference will not occur in a particular installation. If this equipment does cause harmful interference to radio or television reception, which can be determined by turning the equipment off and on, the user is encouraged to try to correct the interference by one or more of the following measures:

- Reorient or relocate the receiving antenna.
- Increase the separation between the equipment and receiver.
- Connect the equipment into an outlet on a circuit different from that to which the receiver is connected.
- Consult the dealer or an experienced radio/TV technician for help.

Any special accessories needed for compliance must be specified in the instruction manual.

Warning: A shielded-type power cord is required in order to meet FCC emission limits and also to prevent interference to nearby radio and television reception. It is essential that only the attached power cord be used.

Use only shielded cables to connect I/O devices to this computer.

You are cautioned that changes or modifications not expressly approved by the party responsible for compliance could void your authority to operate the equipment.

This digital apparatus does not exceed the Class B limits for radio noise emissions from digital apparatus as set out in the radio interference regulations of the Canadian Department of Communication.

Le Présent appareil numérique n'émet pas de bruits radioélectriques dépassant les limites applicables aux appareils numériques de Class B prescrites dans le règlement sur le brouillage radioélectrique édicté par le Ministère des Communications du Canada.

# Warning

---

## *Reconfiguring*

- To keep the computer from being damaged, NEVER reconfigure the board while the power is ON.
- If you wish to reconfigure the computer at any time, ensure that the power is turned OFF before changing any hardware settings, such as DIP switches or jumpers.

# Contents

---

<b>Chapter 1</b>	
<b>System Overview</b>	<b>1</b>
I-1 Introduction	2
Operating System	2
I-2 QuickStart	3
I-3 Features	4
I-4 Specifications	5
I-5 Example of a System Configuration	6
I-6 SystemUnit	7
I-7 Control Panel	8
Reset Button	8
Turbo Button	8
Indicator Lights	8
Keyboard Lock	9
System Power Switch	10
I-8 Rear Panel	11
Keyboard Connector	12
Power Cord Connector	13
Display Port	14
Power Voltage Setting	15
I-9 Other Peripherals	16
I-10 Disk Drives	17
Floppy Disks	18
Hard Disks	20
I-11 Keyboard	21
I-1 2 Maintaining Your Equipment	22

## **Chapter 2**

### **Setting Up Your System . . . . . 1**

2-1 Motherboard . . . . .	
80386S X CPU . . . . .	
Math Coprocessor . . . . .	
Chip Insertion . . . . .	
Jumper . . . . .	
Onboard System Memory Size . . . . .	
ROM BIOS Chips . . . . .	
2-2 Installation . . . . .	20
2-3 Connection to Power Supply. . . . .	21

## **Chapter 3**

### **Operating Your System . . . . . 1**

3-1 An Introduction to DOS . . . . .	2
Loading DOS . . . . .	2
System Messages . . . . .	2
3-2 DOS Operations . . . . .	3
Starting MS-DOS . . . . .	3
Formatting Disks . . . . .	4
Backing up Your Diskettes and Files. . . . .	5
Deleting Your Diskettes and Files . . . . .	6
Finding Out What is on Your Disk . . . . .	7
3-3 Hard Disk Drive Format . . . . .	8
Step 1 – Preformat . . . . .	8
Step 2 – Partition . . . . .	8
Step3-Format . . . . .	9
3-4 Helpful Hints . . . . .	10
3-5 System Setup Program . . . . .	11
Entering the Setup Program . . . . .	12
Running the Setup Program . . . . .	14

**Chapter 4**  
**Keyboard . . . . . 1**

- 4-1 Keyboard Layout . . . . . 2
- 4-2 Getting Acquainted with Your Keyboard . . . . . 3
  - Function Keys . . . . . 3
  - Numeric Keypad . . . . . 3
  - Mode Indicator Lights . . . . . 5
  - Special Keys . . . . . 6
  - QWERTY keys . . . . . 7
  - Cursor Keys . . . . . 8
  - Key Combinations . . . . . 8
- 4-3 Keyboard Tilt Adjustment . . . . . 9

**Chapter 5**  
**Troubleshooting . . . . . 1**

- 5-1 Command Problems . . . . . 2
- 5-2 System Error Messages . . . . . 4
  - Examples of System Error Messages . . . . . 5
- 5-3 System BIOS Error Messages . . . . . 6

## Chapter 6

### Appendix . . . . . 1

6 -1 Installing Disk Drives . . . . .	2
5.25" Disk Drives . . . . .	2
3.5" Disk Drives . . . . .	7
6-2 Entering 20MHz Turbo Mode . . . . .	9
Entering 20 MHz Turbo Mode . . . . .	9
SoftwareTurbo Switch . . . . .	9
Hardware Turbo Switch . . . . .	9
Alternate Use of Both Switches . . . . .	9
6-3 Software . . . . .	10
Shadow RAM Enable . . . . .	10
EMS Driver Setup . . . . .	10
6-4 Quick Reference for Jumper Settings . . . . .	14
6-5 Moving Your Computer and Peripherals . . . . .	16
Short Move . . . . .	16
Long Move . . . . .	16
6-6 Technical information . . . . .	17
Microprocessor . . . . .	17
Protected Virtual Address Mode . . . . .	17
Real Address Mode . . . . .	18
System Timers . . . . .	18
System Interrupts . . . . .	19
ROM Subsystem . . . . .	20
RAM Subsystem . . . . .	20
Direct Memory Access . . . . .	21
DMAChannel . . . . .	21
I/O Channel Slots . . . . .	23
Math Coprocessor Control . . . . .	24

## Chapter 7

### Glossary . . . . . 1



# List of Figures

---

## Chapter 1 System Overview

Figure 1-1: Quick Start . . . . .	3
Figure 1-2: System Configuration . . . . .	6
Figure 1-3: System Unit Case . . . . .	7
Figure 1-4: Front Panel . . . . .	8
Figure 1-5: Keylock and Two Security-Lock Keys . . . . .	9
Figure 1-6: ON/OFF Switch in OFF Position . . . . .	10
Figure 1-7: Rear Panel . . . . .	11
Figure 1-8: Connecting the Keyboard Cable . . . . .	12
Figure 1-9: System Power Cord . . . . .	13
Figure 1-10: Two Kinds of Display Connectors . . . . .	14
Figure 1-11: Voltage Switch . . . . .	15
Figure 1-12: System Unit Connected to Peripherals . . . . .	16
Figure 1-13: Installing Floppy and Hard Disk Drives . . . . .	17
Figure 1-14: Copy Protection for a 3.5" Floppy Disk . . . . .	19
Figure 1-15: Copy Protection for a 5.25" Floppy Disk . . . . .	19
Figure 1-16: Keyboard . . . . .	21

## Chapter 2 Setting Up Your System

Figure 2-1 : Motherboard Layout . . . . .	2
Figure 2-2: The Location of W9,80386SX, and 80387SX . . . . .	5
Figure 2-3: Chip Insertion . . . . .	6
Figure 2-4: An Example of Three-Pin Jumper Setting . . . . .	7
Figure 2-5: RAM Banks & Jumpers for Bank Selection . . . . .	8
Figure 2-6: 512KB Total Onboard System Memory . . . . .	10
Figure 2-7: 640KB Total Onboard System Memory . . . . .	11
Figure 2-8: 1 MB Total Onboard System Memory . . . . .	12
Figure 2-9: 1.5MB Total Onboard System Memory . . . . .	13
Figure 2-10: 2MB Total Onboard System Memory (A) . . . . .	14
Figure 2-11: 2MB Total Onboard System Memory (B) . . . . .	14
Figure 2-12: 3MB Total Onboard System Memory . . . . .	15
Figure 2-13: 4MB Total Onboard System Memory . . . . .	16
Figure 2-14: 5MB Total Onboard System Memory . . . . .	17
Figure 2-15: Installing ROM . . . . .	19
Figure 2-16: Unpacking Your Main System . . . . .	20
Figure 2-17: Connecting to a Power Supply . . . . .	21

## Chapter 3 Operating Your System

Figure 3-1: Initial Screen . . . . .	13
Figure 3-2: "Set Up System Configuration" Screen . . . . .	15
Figure 3-3: "Preformat Hard Disk" Screen . . . . .	16
Figure 3-4: Calculator . . . . .	17
Figure 3-5: "NEAT Chip Setup Configuration" Screen . . . . .	18

## Chapter 4 Keyboard

Figure 4-1 : Keyboard Layout . . . . .	2
Figure 4-2: Function Keys . . . . .	3
Figure 4-3: Numeric Keypad . . . . .	3
Figure 4-4: Indicator Lights . . . . .	5
Figure 4-5: Special Keys . . . . .	6
Figure 4-6: QWERTY Keys . . . . .	7
Figure 4-7: Cursor Keys . . . . .	8
Figure 4-8: Adjustment of Keyboard Angles . . . . .	9

## Chapter 6 Appendix

Figure 6-1 : Installing a 5.25" Disk Drive . . . . .	2
Figure 6-2: Screwing the 5.25" Disk Drives . . . . .	3
Figure 6-3: Connecting a Floppy Disk Drive . . . . .	4
Figure 6-4: Connecting a Floppy Disk Drive to an FDC Card . . . . .	4
Figure 6-5: Connecting a Hard Disk Drive . . . . .	5
Figure 6-6: Connecting a Hard Disk Drive to an HDC Card . . . . .	5
Figure 6-7: Cables for Disk Drives . . . . .	6
Figure 6-8: Installing a 3.5" Disk Drive . . . . .	7
Figure 6-9: Screwing the 3.5" Disk Drives . . . . .	8
Figure 6-10: 62-Pin Expansion Bus I/O Channels . . . . .	23
Figure 6-11: 36-Pin Expansion Bus I/O Channels . . . . .	24

# List of Tables

---

## Chapter 1 System Overview

Table 1-1 : Power Cord Specifications . . . . .	15
Table 1-2: Floppy Disk Specifications . . . . .	18

## Chapter 2 Setting Up Your System

Table 2-1 : Math Coprocessor Jumper W9 . . . . .	4
Table 2-2: Settings of Jumpers W1 -W6 . . . . .	9
Table 2-3: Total Onboard System Memory Size . . . . .	9
Table 2-4: Jumper Settings for Different Types of BIOS . . . . .	18
Table 2-5: Power Supply Pinouts . . . . .	22

## Chapter 4 Keyboard

Table 4-1 : Functions of Numeric Keypad Keys . . . . .	4
Table 4-2: Functions of Special Keys . . . . .	6
Table 4-3: Functions of Special QWERTY Keys . . . . .	7
Table 4-4: Special Functions . . . . .	8

## Chapter 6 Appendix

Table 6-1: Channel . . . . .	18
Table 6-2: Channel 1 . . . . .	18
Table 6-3: Channel 2 . . . . .	18
Table 6-4: Interrupt Level Assignment . . . . .	19
Table 6-5: DMA Channels . . . . .	21
Table 6-6: I/O Hex Address . . . . .	22
Table 6-7: DMA Channel 3 Through 0 . . . . .	22
Table 6-8: DMA Channel 7 Through 5 . . . . .	22

# About This Manual

---

## What's Inside

---

Here's what you'll find in this manual:

**Chapter 1** — “*System Overview*”, gets you acquainted with the basic concepts of your system.

**Chapter 2** — “*Setting Up Your System*”, shows you how to install or upgrade your system.

**Chapter 3** — “*Operating Your System*”, shows you the MS-DOS functions and the basics of the system setup program.

**Chapter 4** — “*Keyboard*”, explains the keyboard's features, layout and basic functions.

**Chapter 5** — “*Troubleshooting*”, covers a simple troubleshooting procedure and provides directions for additional help.

**Chapter 6** — “*Appendix*”, provides some technical specifications for your system.

**Chapter 7**— “*Glossary*”, explains some microcomputer terms.

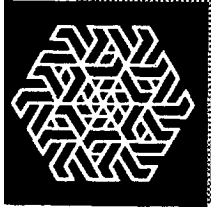
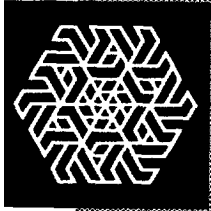
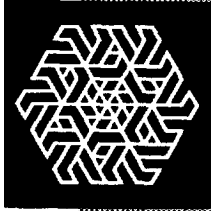
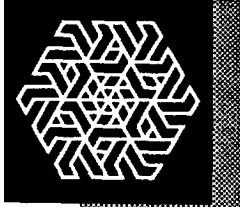
### ***For the advanced user***

If you are an experienced PC user and do not want to upgrade your system now and you want to start using your personal computer as soon as possible, refer to the *Quick Start* section at the beginning of chapter one.

Quick Start will provide you all the information you need to set up the hardware.

### ***For the beginner***

Chapter 1 gives you the basic information you need to use this system. Chapter 2 provides greater detail on the hardware and on how to upgrade your system. Your system is quite simple to set up. However if you are unsure of yourself, find an experienced PC hand to help out.



# ***Chapter 1***

## ***System Overview***

# System Overview

---

This chapter covers:

- the basics of your system
- the system's features and specifications
- control panel features and connectors outside of the Case
- how to maintain your computer.

If you are an experienced user who wants to get to work as soon as possible, the *Quick Start* section at the beginning of this chapter provides you all the information you need to set up the hardware.

If you want to upgrade your hardware later, read Section 2-2: Installation.

If you want to gain a more thorough understanding of your computer, read the entire manual.

**Note:**

You may refer to Chapter 7: Glossary for definitions of computer terminology.



## 1-1 Introduction

---

This manual will guide you through the setup of your computer and provide the information necessary to tailor the system to fit your needs. If you are a novice, you will be able to have your computer up and running with a minimum of fuss. You will also gain valuable hands-on experience by following the easy step-by-step instructions. If you are an advanced user, you will appreciate the affordable power of this system.

Your system uses an Intel Corporation™ 80386SX microprocessor which is a 32-bit CPU with a 16-bit external data bus and a 24-bit external address bus. It provides the performance benefits of a 32-bit programming architecture and the cost savings associated with 16-bit hardware systems. Moreover, it is 100% object-code compatible with the 386, 286, and 8086 microprocessors. Therefore, your system optimizes both for performance and cost. It can access the world's largest existing microcomputer software base, including the growing collection of 32-bit software.

Quality, flexibility, and functionality are the key design features of your system. This system provides optimum performance at an affordable price.

### **Operating System**

---

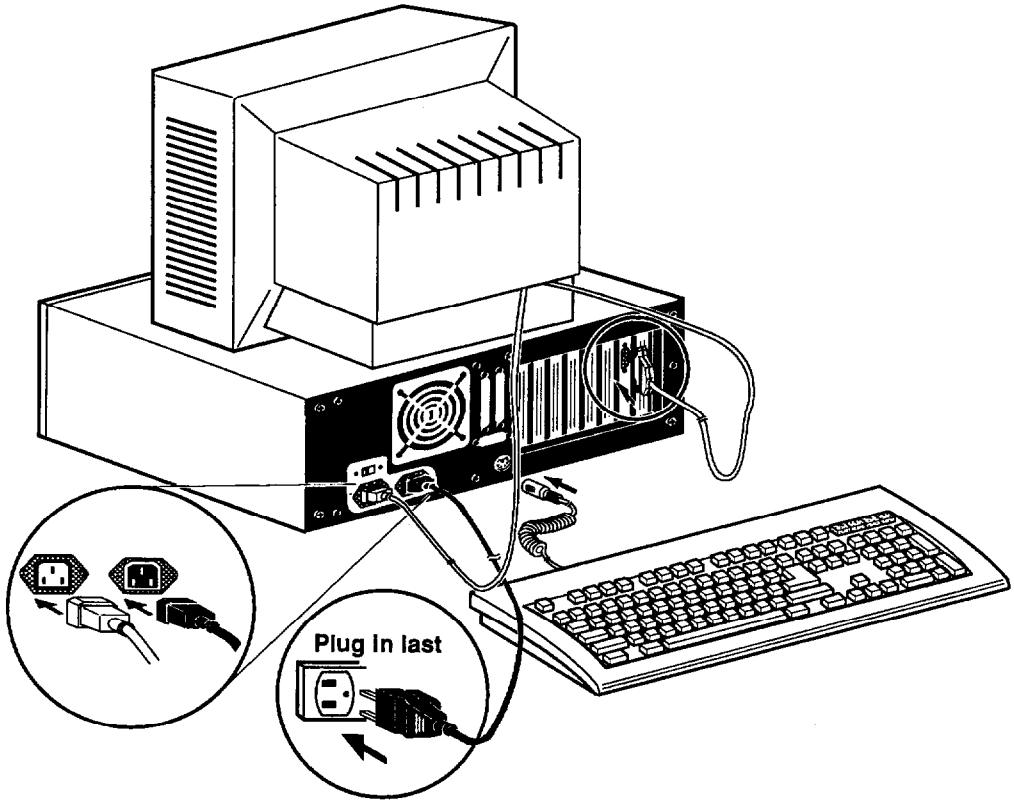
Your computer uses the MS-DOS® operating system. For more details on this operating system, please refer to the Microsoft® *MS-DOS User's Guide* and *User's Reference*. This manual is included with your system.

## 1-2 Quick Start

---

If you are an experienced user anxious to start using your computer, observe the figure below to set up your personal computer. You will still want to use this manual later as a reference book.

Note: Save all packing materials in case you need to ship or resell your computer in the future.



**Figure 1-1: Quick Start**

## 1-3 Features

---

- Intel 80386SX-20 microprocessor—32-bit CPU with a 16-bit external data bus and a 24-bit external address bus
- Intel 80387SX-20 coprocessors optional
- Switchable between 10MHz Normal mode and 20MHz Turbo mode by either a software-switch or a hardware switch
- Onboard battery backup for the CMOS configuration table and a real-time clock
- RAM subsystem of 512K/1,640KB, 1 MB, 1.5MB, 2MB, 3MB, 4MB and 5MB
- Eight expansion slots — six 16 bit slots and two 8 bit slots
- Sixteen-level interrupt
- Seven-channel DMA for disk and special I/O
- 64KB legal BIOS
- Four-layer mainboard
- LIM 4.0 EMS support
- Shadow RAM support
- Choice of either 44256 DIP or 256k/1M SIMM DRAM modules with 80ns
- Page/Interleaved DRAM access method support
- Power fail detect circuit
- Address pipeline support

## 1-4 Specifications

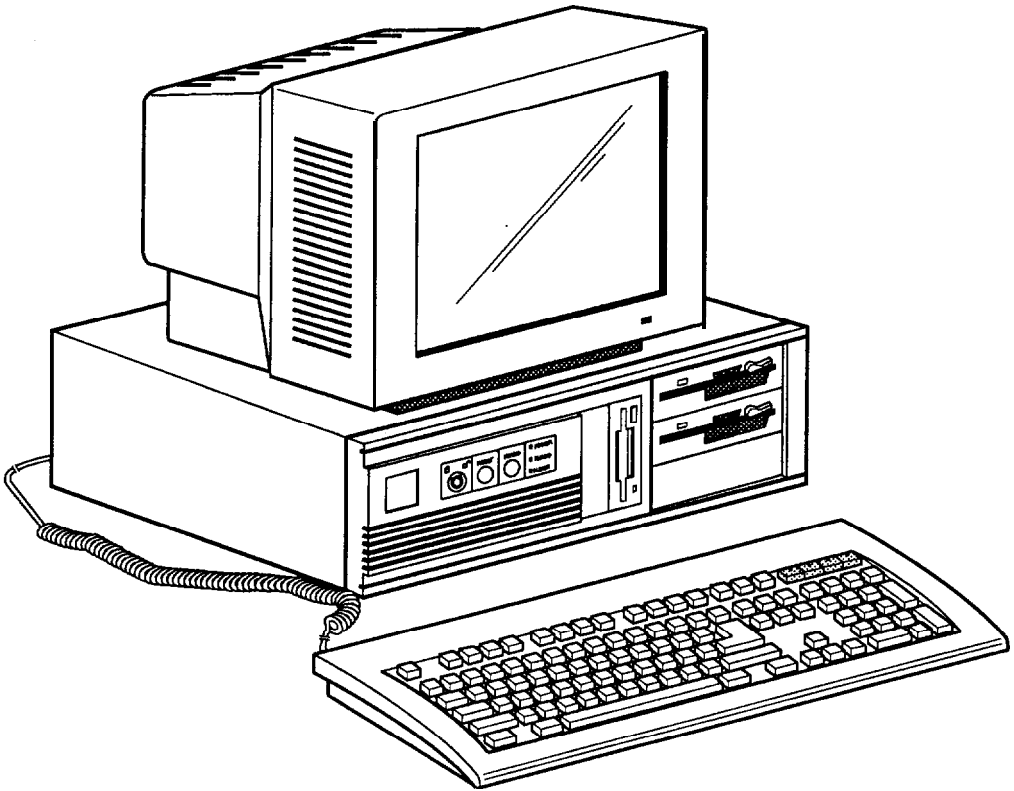
---

- **CPU** — 80386SX microprocessor, 20MHz
- **RAM** — Subsystem of 512KB, 640KB, 1 MB, 1.5MB, 2MB, 3MB, 4MB and 5MB
- **ROM** — 64KB legal BIOS
- **Expansion slots** — Six 16 bit slots and two 8 bit slots
- **Disk Drive(s)** — Three 5.25" bays and two 3.5" bays
- **Power Size** — 165mm X 150mm X 150mm
- **Options** — Math coprocessor 80387SX-20

## 1-5 Example of a System Configuration

---

The basic system is pictured below. You may choose peripherals and upgrades for the system as your needs require. Even if your system is different from the one pictured, it should operate in the same basic manner.

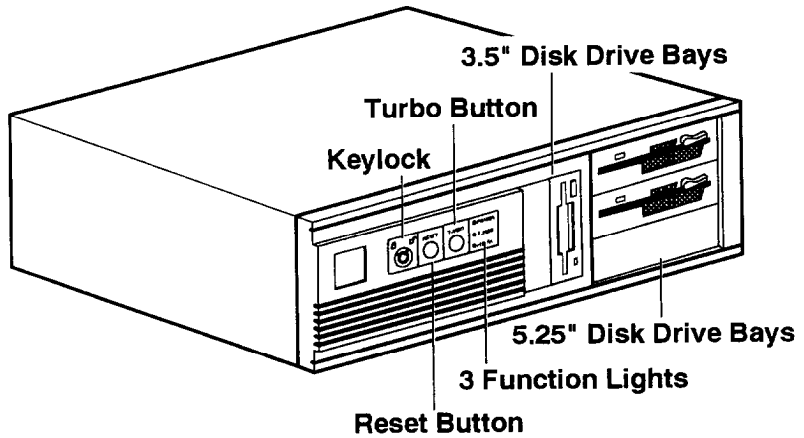


**Figure 1-2: System Configuration**

## 1-6 System Unit

---

The system unit may house a motherboard, disk drives, a power supply and an optional expansion cards.

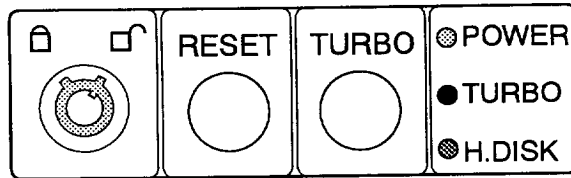


*Figure 1-3: System Unit Case*

## 1-7 Control Panel

---

The control panel provides several useful functions which are explained below. You are likely to use the front panel frequently, so let's start there.



**figure 14: Front Panel**

---

### Reset Button

The reset button allows you to restart the system without turning the lower off.

If you encounter any problems while using unfamiliar software, you can always restart quickly from the RAM test stage by pressing the reset button. Note, however, that any data which have not been saved to disk will be lost.

---

### Turbo Button

The Turbo button allows you to change the running speed of the microprocessor to accommodate software requirements. Some software applications must be run at a slow clock speed.

---

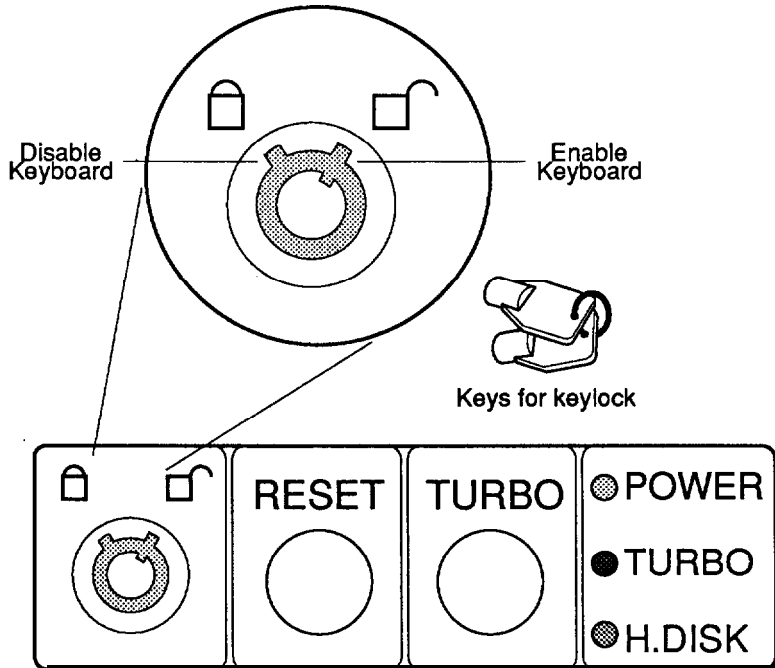
### Indicator Lights

These lights indicate the operation status of your computer.

- The *green* LED is lit when the power is on.
- The *yellow* LED comes on when Turbo clock speed is activated.
- The *red* LED comes on when the hard disk is being accessed.

## Keylock

The keylock enables or disables the keyboard. In the unlock mode the keyboard is activated. In the lock mode the keyboard is disabled to deny unauthorized users access to the computer.

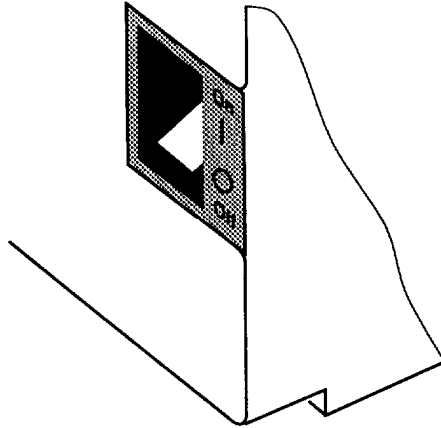


**Figure 1-5: Keylock and Two Security-Lock Keys**



## System Power Switch

The system power switch is located on the right side of the case toward the rear.

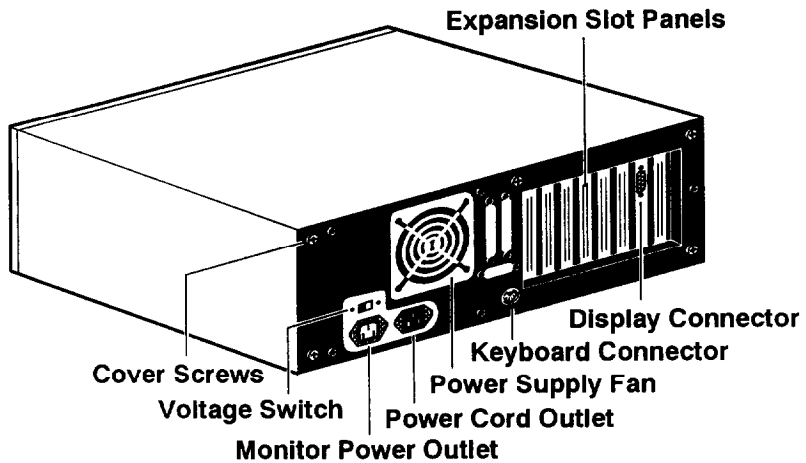


**Figure 1-6: ON/OFF Switch in OFF Position**

You should always be certain that the power is turned off before modifying the hardware configuration in any way.

## 1-8 Rear Panel

The rear panel has all the connections that lead from the system unit to external peripherals and the power source. **Turn off all power switches before connecting or disconnecting cables/wires!** Ensure that cables/wires are attached to the peripheral device first and connect to the outlet unit later. Turn the system unit power switch off before you plug the power cable into an electrical outlet.

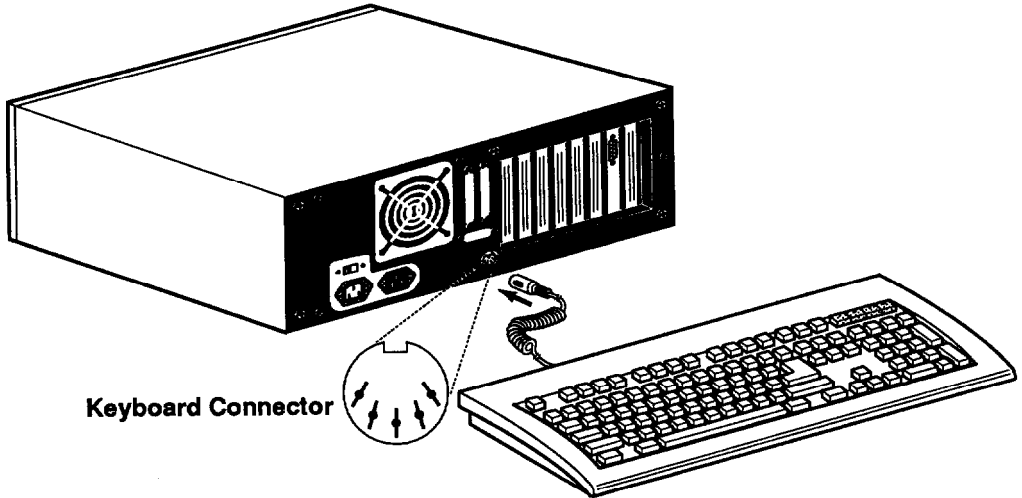


*Figure 1-7: Rear Panel*

## Keyboard Connector

---

The keyboard supplied with your system may be plugged into sockets at the back of the case. Plug the keyboard cable into the socket as shown below.



*Figure 1-8: Connecting the Keyboard Cable*

## Power Cord Connector

The power supply has two receptacles: one supplies power to a monitor; the other connects to the main power source.

If your monitor power plug does not fit the system unit's monitor power outlet, you should plug it into a wall electrical outlet.

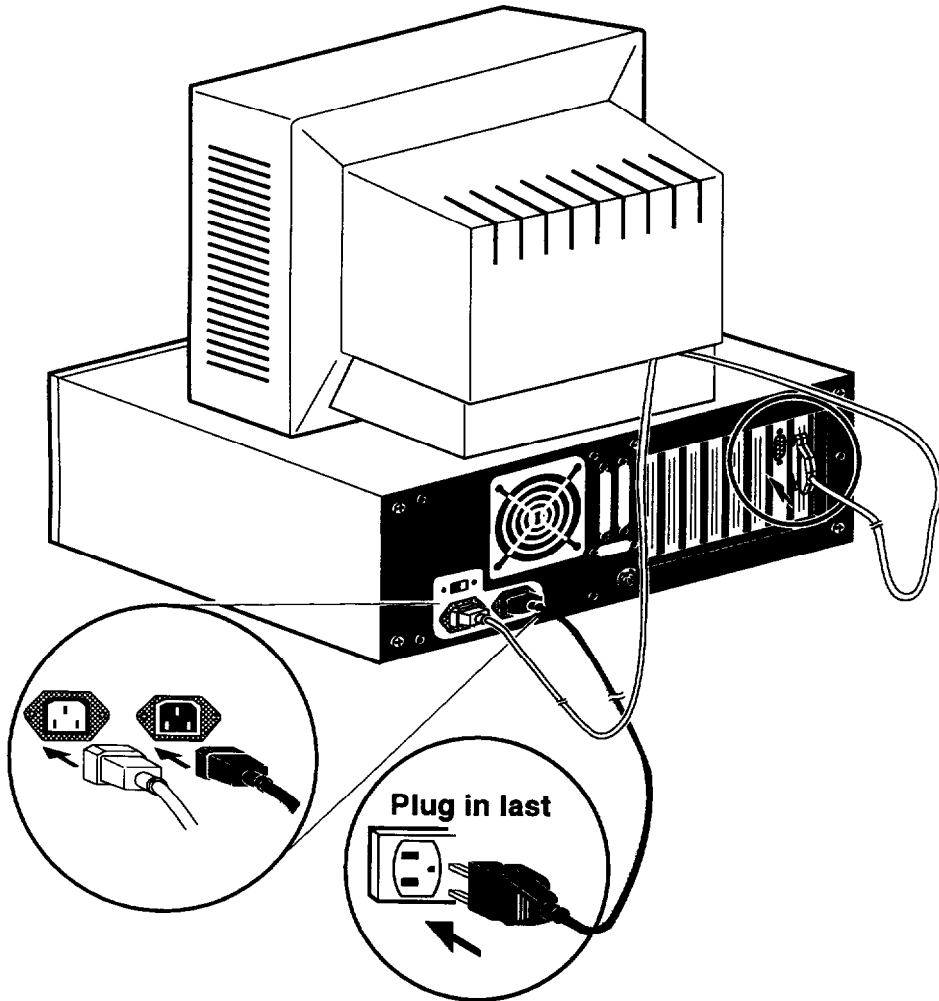


Figure 7-9: System Power Cord

## Display Port

You will also need to connect your monitor to the system unit at a female display port in one of the expansion slots as shown on the previous page.

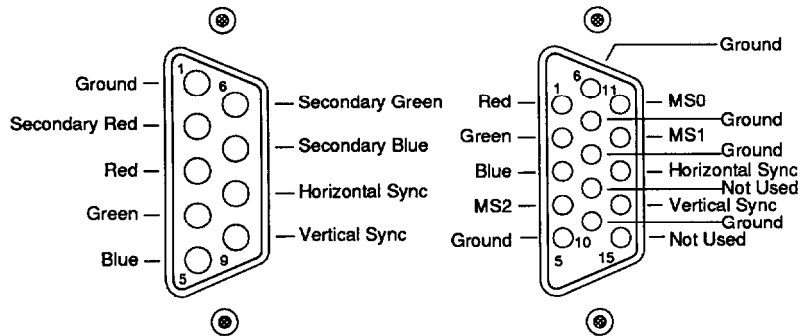
To attach the monitor cable to the display port, plug the cable into the port and screw the cable connector down securely.

Your computer gives you a wide range of video options to meet your needs.

You have a wide choice of the following video standards.

- MGA (Monochrome Graphics Adapter) also referred to as Hercules
- CGA (Color Graphics Adapter)
- EGA (Enhanced Graphics Adapter)
- VGA (Video Graphics Adapter)

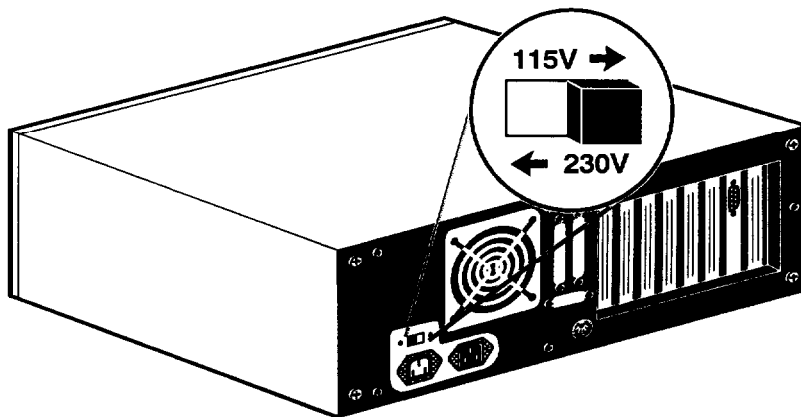
Refer to the figures below for mono and color display connectors.



**Figure 1-10: Two Kinds of Display Connectors**

## Power Voltage Setting

The system unit can run on either 115V or 230V as indicated in Figure 1-11. The voltage setting switch is located above the monitor power outlet. Refer to Table 1-1 for power cord specifications.



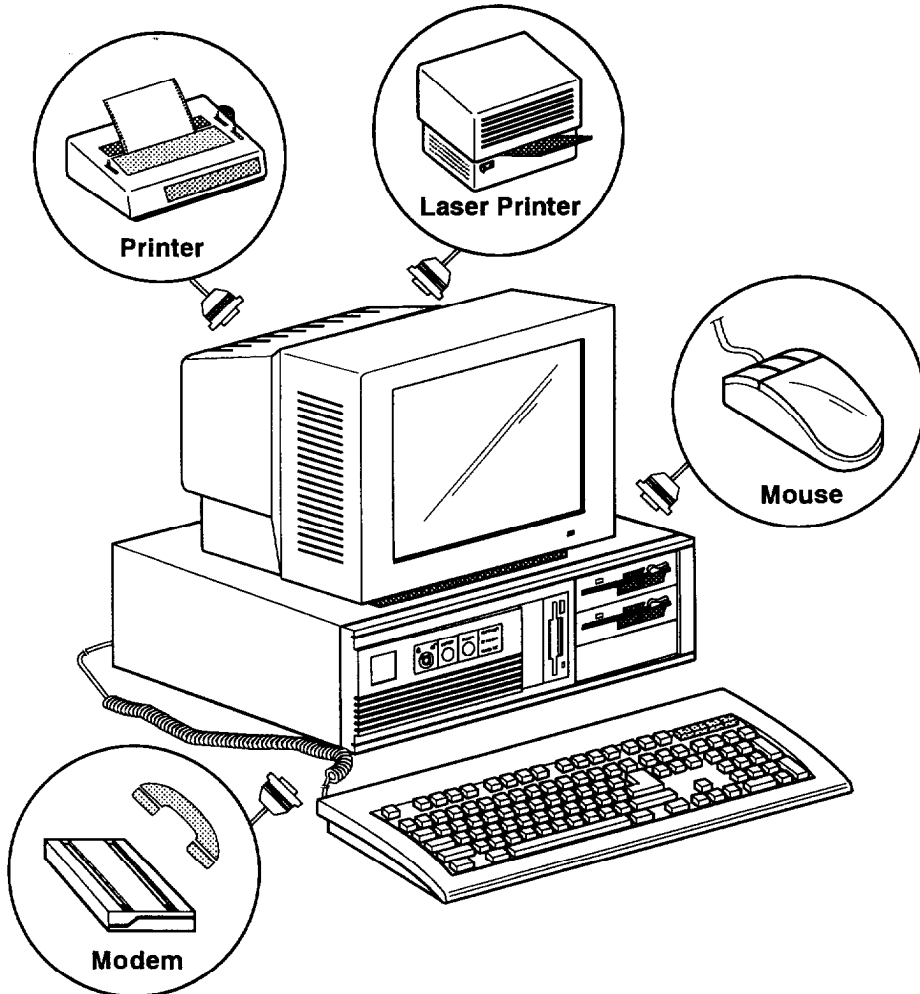
*Figure 1-1: Voltage Switch*

Power Source	Cord Specification
115V	UL listed; SVT/SJT type; three-conductor rated 10A, 125V; <15ft. in length
230V	Appropriate approval listed in that specific country; three-conductor; rated 6A, 250V
230V (U.S.A. only)	UL listed; SVT/SJT type; three-conductor; rated 6A, 125V; <16ft. in length

*Table 1-1: Power Cord Specifications*

## 1-9 Other Peripherals

To connect other peripherals (printer, modem etc.), refer to your expansion card manuals or peripheral manuals to determine which ports are to be used. You may consult your dealer for more about the expansion cards available for your system. Typical peripherals are shown as the figure below.

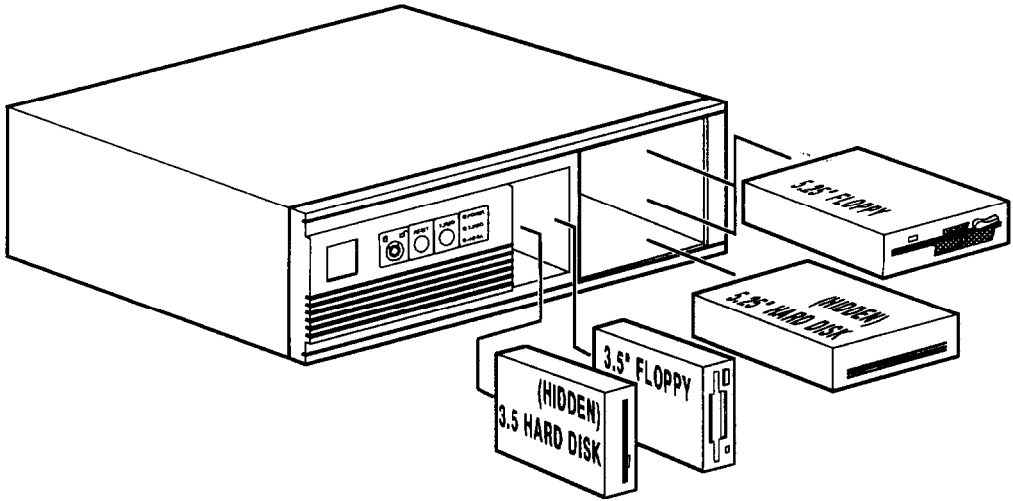


*Figure 1-12: System Unit Connected to Peripherals*

## 1-10 Disk Drives

---

Your disk drive displays different kinds of composition by installing 5.25" or 3.5" size of floppy or hard disk drives. You can decide the composition according to your need. More information about how to install disk drives may be found in Chapter 6.



**Figure 1-13: Installing Floppy and Hard Disk Drives**



## Floppy Disks

With a floppy disk drive you can format and use double-sided (or single-sided) double-density (or high-density) floppy disks.

One double-sided double-density 5.25" floppy disk can store up to 360KB of data. One double-sided high-density 5.25" floppy disk can store up to 1.2MB of data, One standard 3.5" floppy disk can store up to 720KB of data, One high-density 3.5" floppy disk can store up to 1.44MB of data.

Quality	Tracks Per Inch	Capacity	
		5.25"	3.5"
Double Density (DD, DS, RH)	48 TPI	360 KB	720 KB
High Density (DH)	96 TPI	1.2 MB	1.44 MB

**Table 1-2: Floppy Disk Specifications**

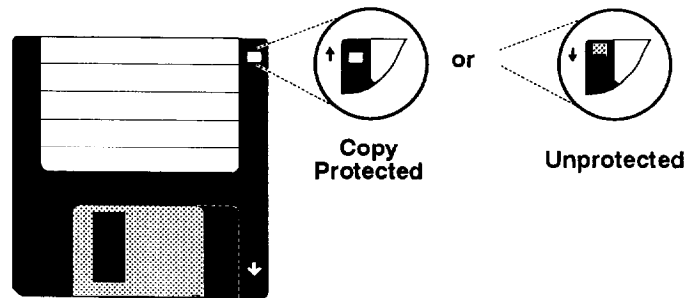
**Note:**

- Only high-density floppy disks can be formatted to high capacities of either 1.2M for 5.25" or 1.44M for 3.5" floppy disks. You may lose data if you use a low-density floppy disk formatted for high density.
- You can't use a high-density disk in a low-density disk drive.

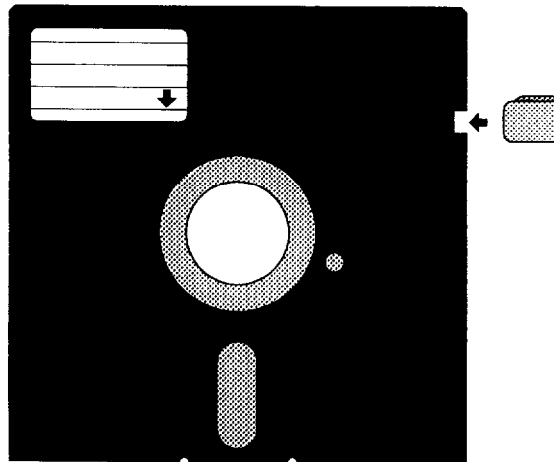
## Copy Protection

You can copy-protect a floppy disk to prevent accidental storage of information or viral infection onto that disk by covering the notch on the side of a 5.25" floppy disk with a write-protect tab or by sliding the small tab on a 3.5" floppy disk to expose the hole. Refer to the figures below for how to copy-protect floppy disks.

When a disk is copy-protected, you cannot add new information to it or change any information on it. To enable copying to the disk, remove the copy-protecting tab on a 5.25" floppy disk or slide the tab to show the hole on a 3.5" floppy disk.



**Figure 1-14: Copy Protection for a 3.5" Floppy Disk**



**Figure 1-15: Copy Protection for a 5.25" Floppy Disk**

## Hard Disks

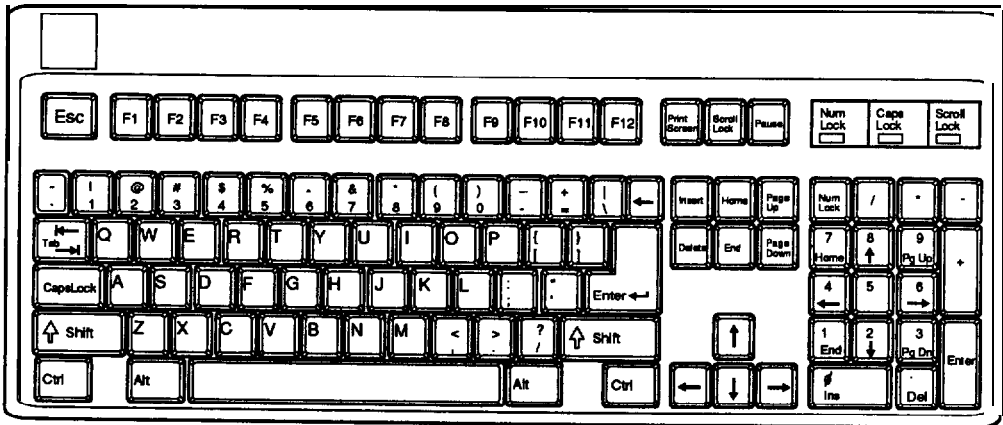
---

Your system is very powerful and versatile. To make full use of all its capabilities, it is best to use a hard disk. A hard disk can raise your efficiency because the hard disk keeps programs and data available at your fingertips.

Moreover, your system gives you a wide range of half-high or full-high hard disk(s) of 3.5" or 5.25" to meet your needs.

## 1-11 Keyboard

Your keyboard has a set of function keys, cursor keys and a numeric keypad. The figure below shows a typical keyboard. Refer to Chapter 4 for a more detailed description of the keyboard.



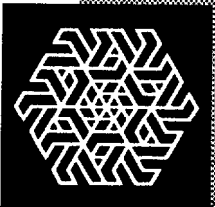
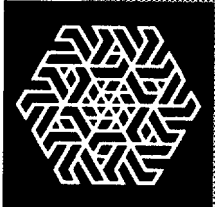
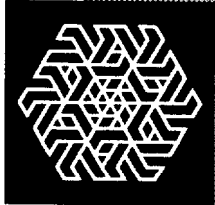
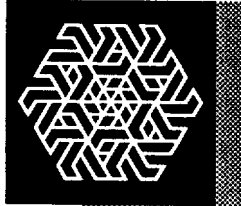
**Figure 1-15: Keyboard**

## 1-12 Maintaining Your Equipment

---

Read and follow carefully all the instructions and warnings in this manual and on these products!

- Only use a damp cloth to clean your system unit and monitor case. **Do not use detergents!**
- Position your system unit, monitor and cables/wires away from direct sunlight, moisture, dust, oil, and thoroughfares.
- Do not submit your equipment to harsh jarring.
- Ensure that all ventilation outlets are always free from obstruction.
- In the event of mechanical/power failure or damage, do not attempt to repair the system unit, monitor/s, cables/wires. Refer all such problems to experienced service personnel.
- Ensure that the back of the system unit is at least 3" away from anything that might obstruct the ventilation outlets and cause overheating.
- Ensure that the power source is grounded correctly. This product is equipped with a 3-wire grounding-type plug. This plug will only fit into a grounded power outlet.
- It is recommended not to service this product yourself, as opening and removing covers exposes dangerous voltage areas and other risks. Refer all servicing to service persons.



## ***Chapter 2***

# ***Setting Up Your System***

# Setting Up Your System

---

In this chapter you will learn about:

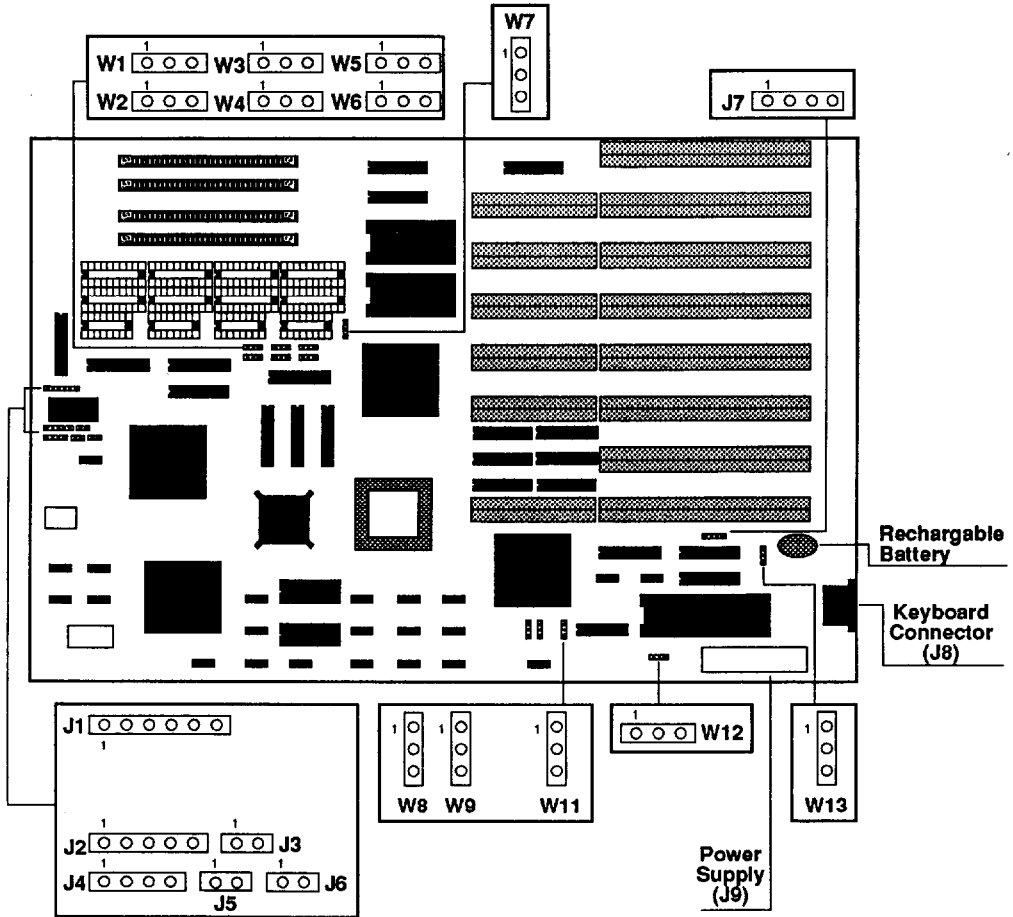
- how to assemble a knocked-down system
- how to upgrade your system

Setting up a system is easy and takes only a short time. If your dealer has set up your system for you, you can skip this chapter. With the system set up you are now ready to load your application software and begin work. This chapter covers topics you are less likely to need to know right away.

You may also skip this chapter unless you want to add to or alter your system unit hardware yourself. It is recommended to have your dealer or technician upgrade your system if you are a novice. Ensure that the power is off before modifying the hardware configuration!

## 2-1 Motherboard

The motherboard contains an Intel® 80386SX-20 processor, a 80387SX math coprocessor socket, BIOS chips and expansion slots. These parts of your system that you can see and touch are called hardware. Below is an illustration of the board layout.



**Figure 2-1: Motherboard Layout**



## 80386SX CPU

---

Your system uses an Intel 80386SX-20 microprocessor running at 20MHz. The 80386SX has a number of features that enable a substantial leap in processing power and capability over the 80286 standard used in AT-type microcomputers. The 80386SX has superior extended memory support and will execute the new 32-bit programs of the future. The 80386SX-20 CPU is vastly superior in capabilities and speed to the 80286, and can handle:

- Concurrent processing
- Hardware-based multitasking
- Superior extended-memory support; and
- Virtual machines

Virtual machines can create discrete, non-interfering operating environments for application programs, giving each application its own working environment. Virtual machines can be created within the extended memory by using appropriate control software.

Your system is switchable between 10 and 20MHz to ensure software compatibility and can be activated with either a hardware or software switch. For software that fails to operate at Turbo mode you may switch to the Normal speed.



## Math Coprocessor

If you process numeric data, a math coprocessor will make your work more efficient.

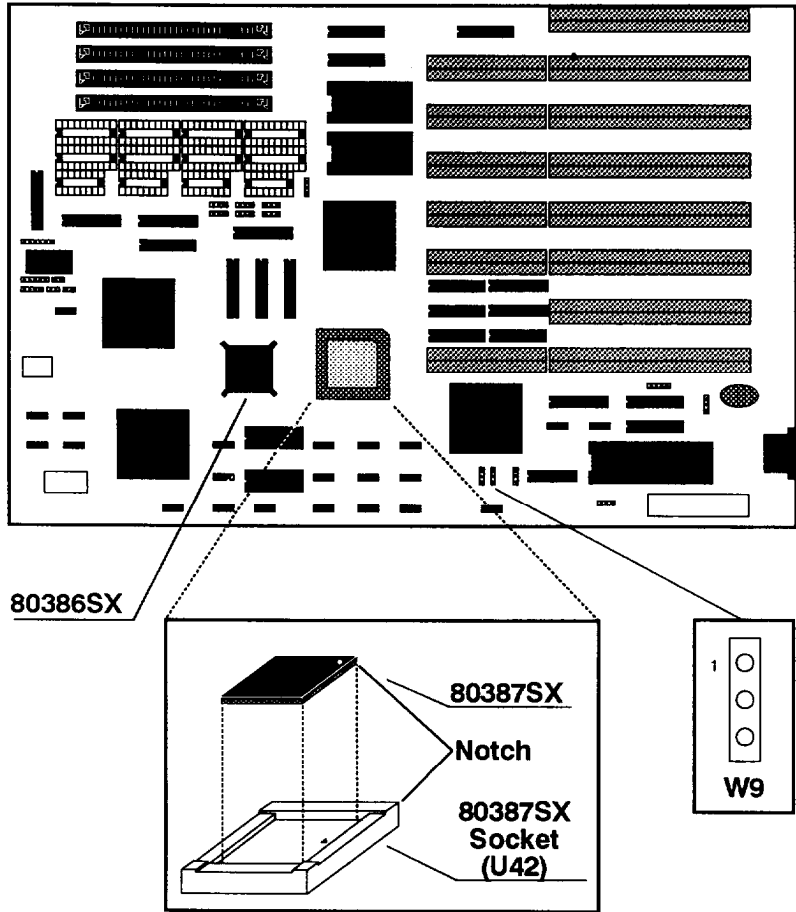
An optional 80387SX-20 coprocessor can be installed in socket U42 to accelerate processing of calculation-intensive applications. Jumper W9 is used to enable or disable the 80387SX math coprocessor.

Remember that you must make sure the dotted end of the chip is lined up with the notched end of the socket. Refer to the illustrations below and on the next page to install the Intel 80387SX-20.

Refer to Table 2-1 below for jumper W9 and Figure 2-2 on the next page for the 80386SX and the 80387SX.

Jumper W9	80387SX
1 	Enable
1 	Disable

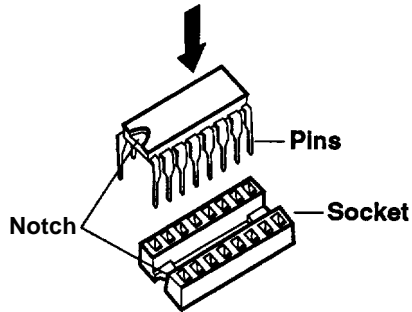
**Table 2-1: Math Coprocessor Jumper W9**



*Figure 2-2 . The Location of W9,80386SX, and 80387SX*

## Chip Insertion

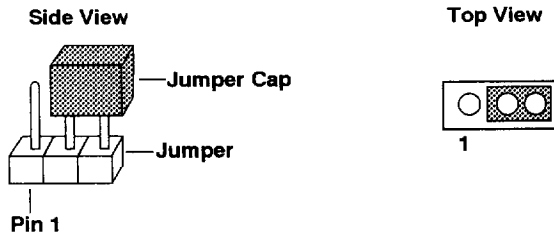
Remember that when inserting chips, you must make sure that the notched or the dotted end of the chip is lined up with the notched end of the socket. Gently push the chip into the socket, and be careful not to bend the pins.



**Figure 2-3: Chip insertion**

## Jumper

A jumper is a kind of switch which uses a plastic cap with a metal interior to connect (short) two pins. If a jumper needs to be left open, you should save the cap for future use by covering only one pin of a jumper. This has no effect on the function of the board while it keeps the cap handy. The illustration below shows the side and top views of a three-pin jumper in which pins two and three are shorted.



**Figure 2-4: An Example of Three-Pin Jumper Setting**

## Onboard System Memory Size

Jumpers W1- W6 are used to set the RAM size you want on the mainboard. The DIP and SIMM DRAM banks can contain from 512KB, 640KB, 1 MB, 1.5MB, 2MB, 3MB, 4MB to 5MB by means of setting jumpers W1 - W6. Refer to Figure 2-5 below for the location of jumpers W1 - W6 and the RAM banks.

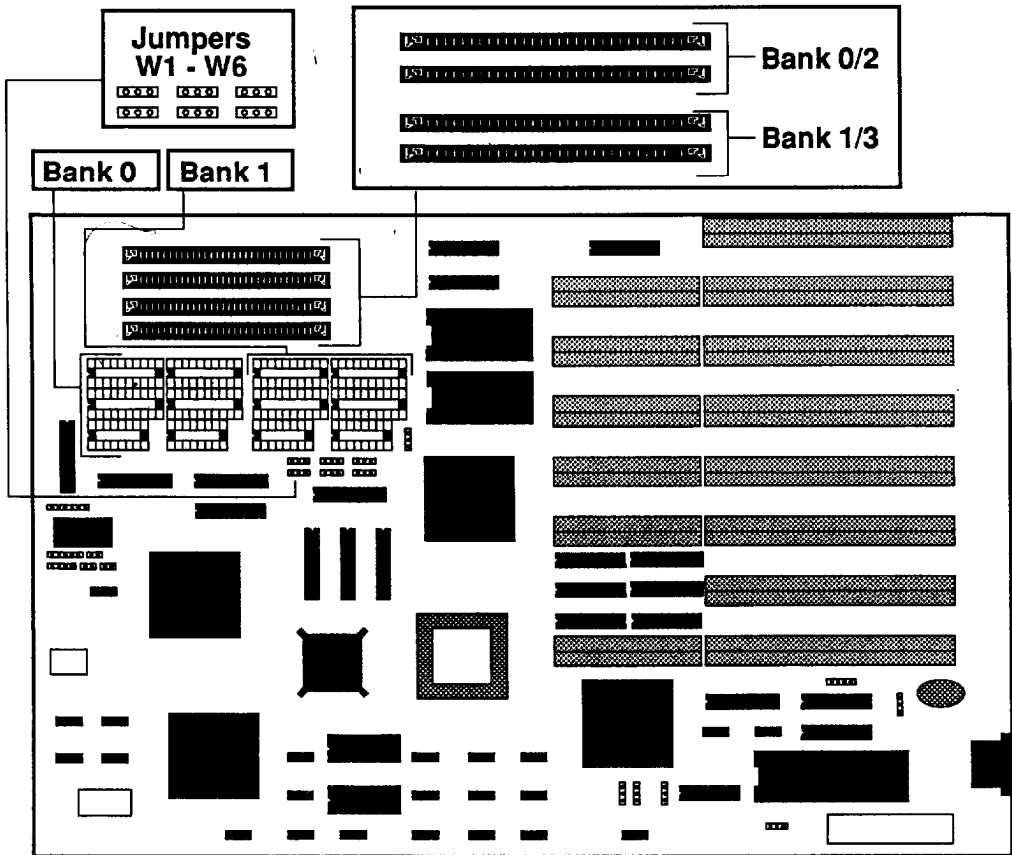
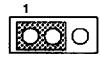



Figure 2-5: RAM Banks & Jumpers for Bank Selection

Following figures show the configuration for total onboard system memory.

Description	W1 - W6 Settings
Using one bank or two banks (banks 0 & 1) with either DIP or SIMM DRAMs as onboard memory	→ 
Using three or four banks of DIP (banks 0, 1) and SIMM (banks 2, 3) DRAMs as onboard memory	→ 

**Table 2-2: Settings of Jumpers W1- W6**

Before setting up **RAM** configuration in BIOS, you must refer to the following table to set the wait state and the page-interleave mode.

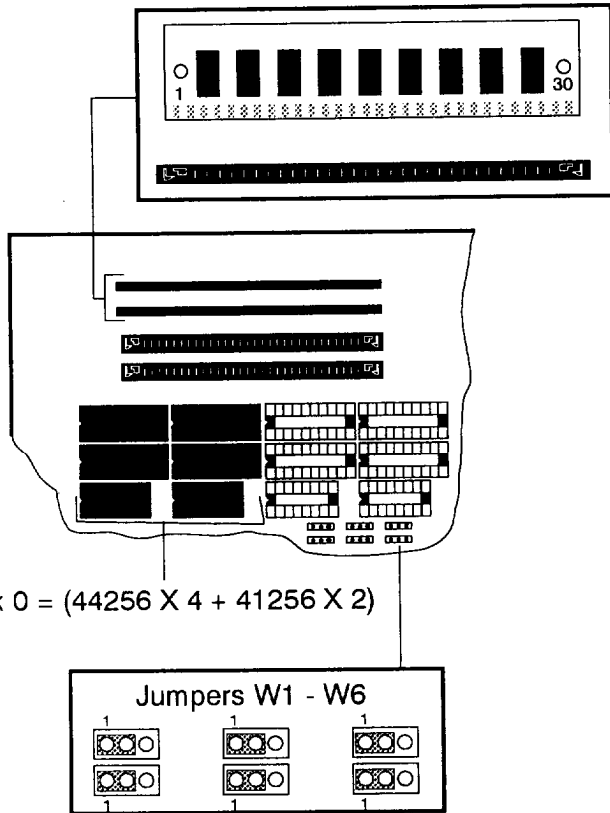
**Particularly, you cannot set both 0 wait state and disabled page-interleave mode in Turbo mode; otherwise your system cannot operate normally, even cannot display the screen. In order to set both modes normally, you should switch the button from Turbo mode to Normal mode.**

Total System Memory	DRAM Type				Wait-State	Page Interleave	Reference
	Bank 0	Bank 1	Bank 2	Bank 3			
512K	256K	0K	0K	0K	1	Disable	Page 10
640K	256K	64K	0K	0K	1	Disable	Page 11
1MB	256K	256K	0K	0K	0	Enable	Page 12
					1	Enable	
					1	Disable	
1.5MB	256K	256K	256K	0K	1	Disable	Page 13
2MB	256K	256K	256K	256K	0	Enable	Page 14
					1	Enable	
					1	Disable	
2MB	1M	0K	0K	0K	1	Disable	Page 14
3MB	256K	256K	1M	0K	1	Disable	Page 15
4MB	1M	1M	0K	0K	0	Enable	Page 16
					1	Enable	
					1	Disable	
5MB	256K	256K	1M	1M	0	Enable	Page 17
					1	Enable	
					1	Disable	

RAM access time is 80ns.

**Table 2-3: Total Onboard System Memory Size**

Bank 0 = 41256 RAM Module x 2 pieces

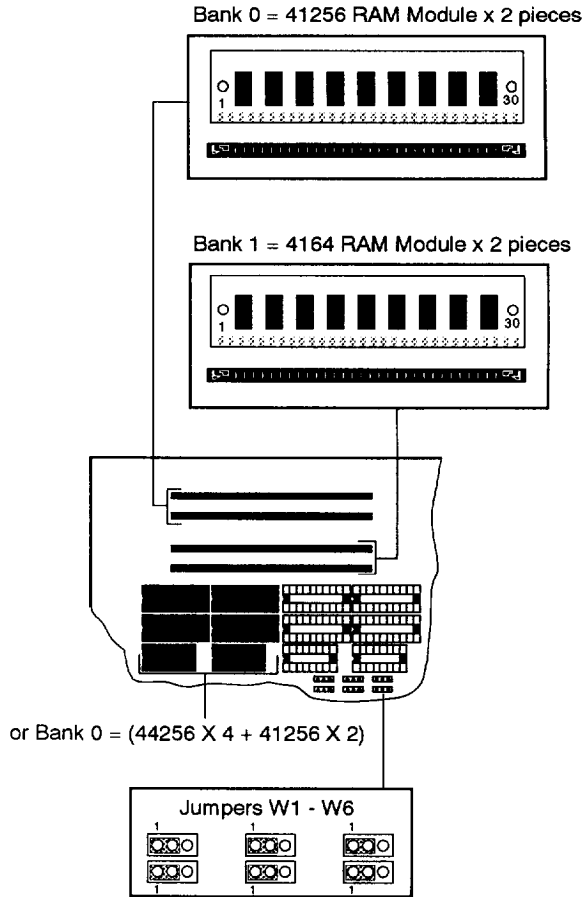


or Bank 0 = (44256 X 4 + 41256 X 2)

You may use either bank as bank 0.

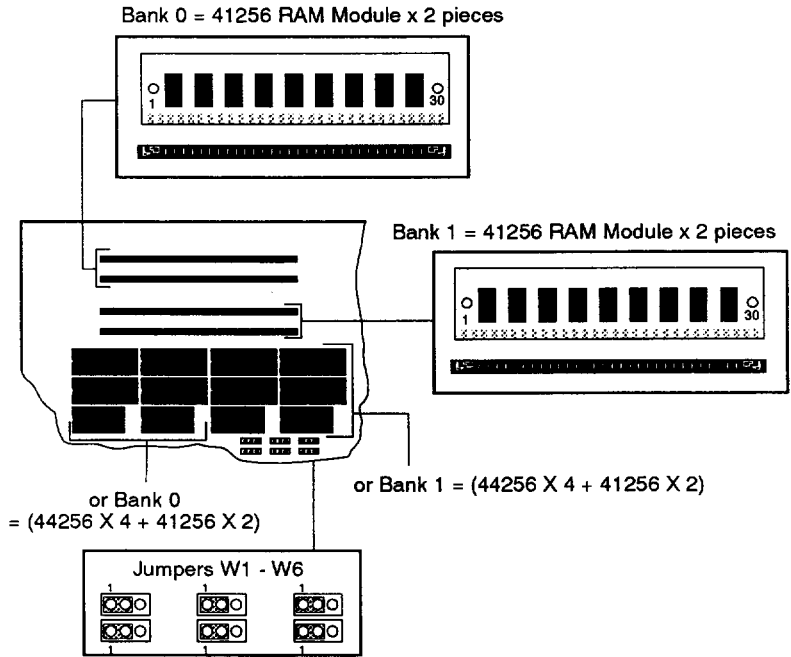
**Figure 2-6: 512KB Total Onboard System Memory**





You may use either bank as bank 0.

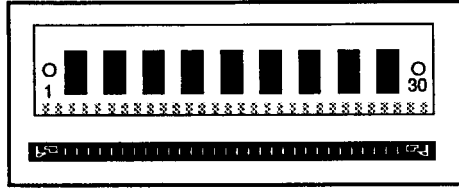
**Figure 2-7: 640 KB Total Onboard System Memory**



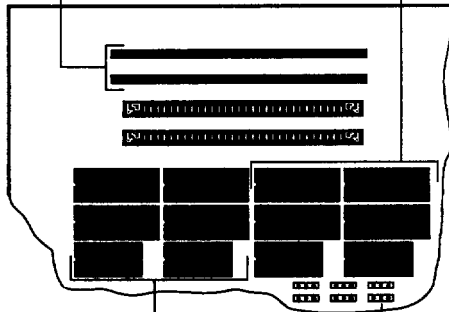
Any bank 0 may be used with any bank 1.

**Figure 2-8: 1 MB Total Onboard System Memory**

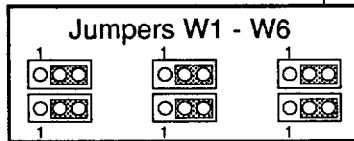
Bank 2 = 41256 RAM Module x 2 pieces



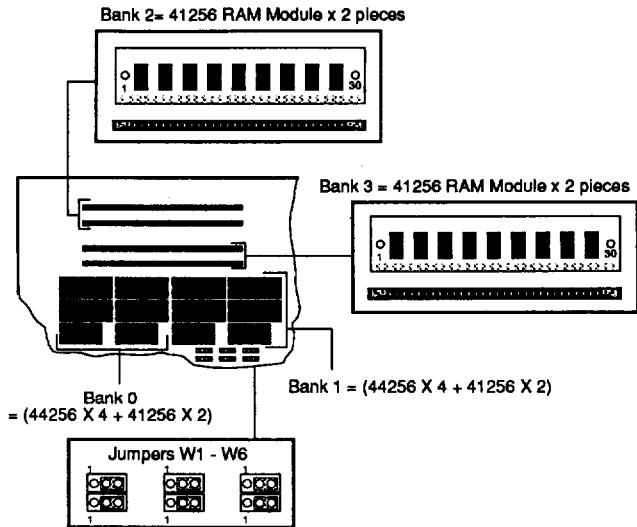
Bank 1 = (44256 X 4 + 41256 X 2)



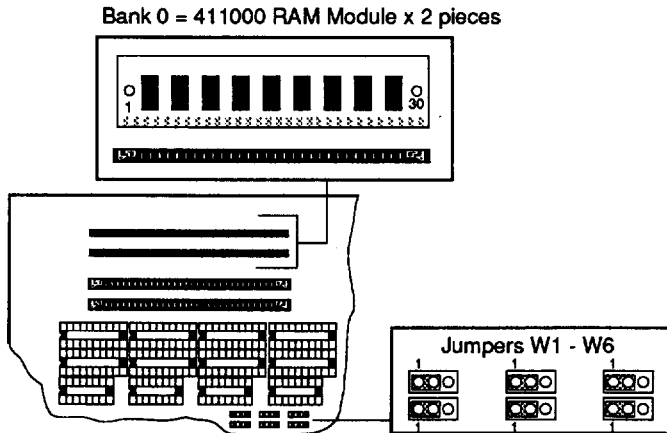
Bank 0 = (44256 X 4 + 41256 X 2)



**Figure 2-9: 1.5 MB Total Onboard System Memory**

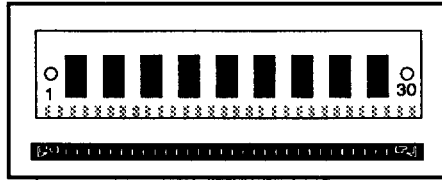


**Figure 2-10: 2MB Total Onboard System Memory (A)**

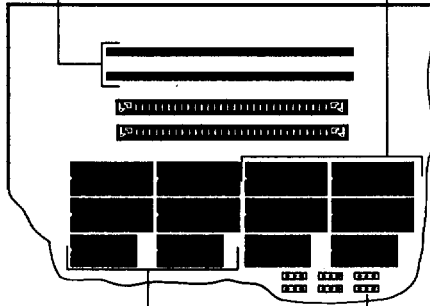


**Figure 2-11: 2MB Total Onboard System Memory (B)**

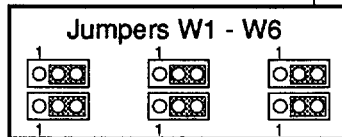
Bank 2 = 411000 RAM Module x 2 pieces



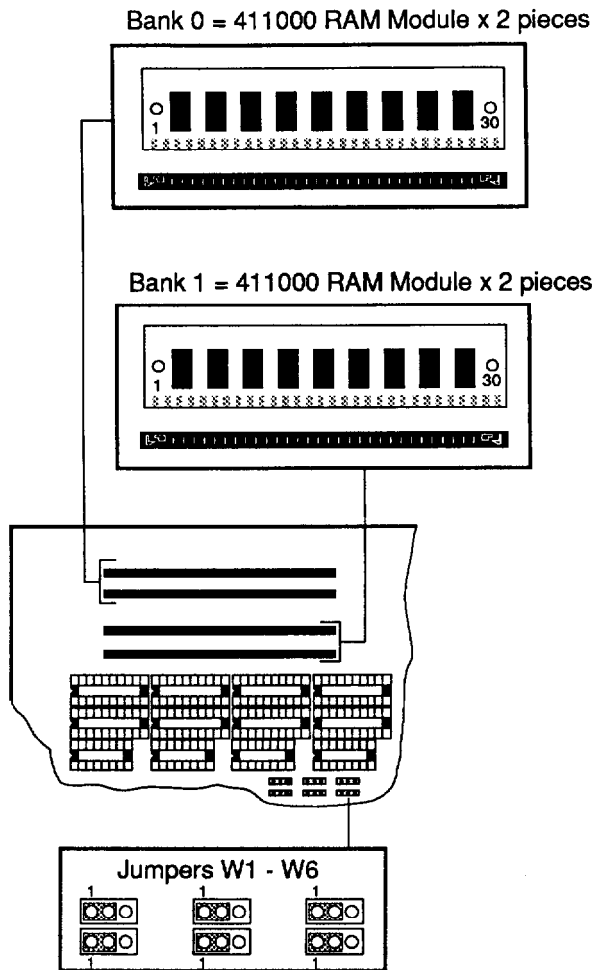
Bank 1 = (44256 X 4 + 41256 X 2)



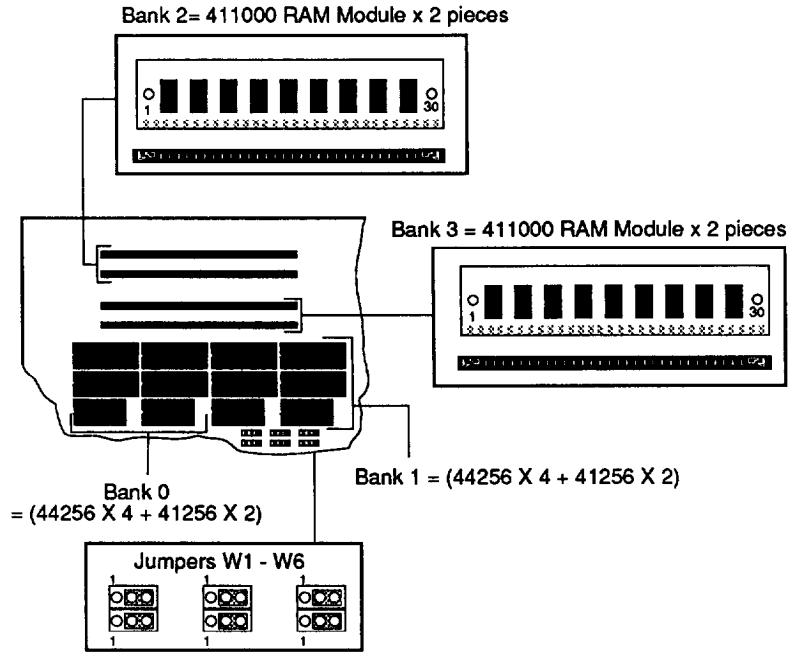
Bank 0 = (44256 X 4 + 41256 X 2)



**Figure 2-12: 3MB Total Onboard System Memory**





**Figure 2-13: 4MB Total Onboard System Memory**



**Figure 2-14: 5MB Total Onboard System Memory**

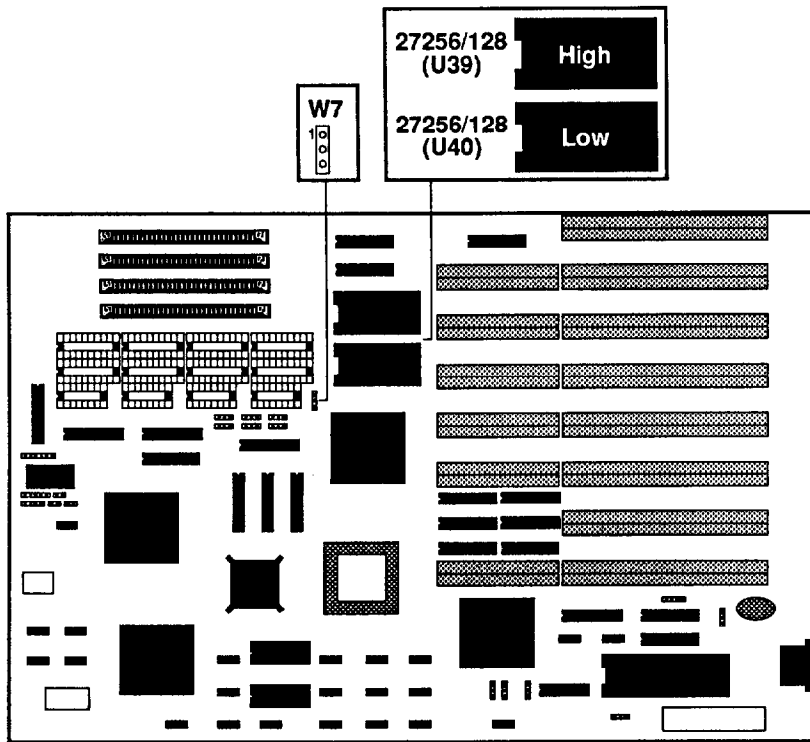
## ROM BIOS Chips

Jumper W7 is used to select the type of BIOS chips. BIOS stands for Basic Input Output System. BIOS controls the real-time clock, disk drives and the computer's peripheral equipment. Refer to the Figure 2-1 5 for the location of jumper W7 and BIOS chips. For selection and installation of the ROM BIOS chips, refer to the table below and the figure on the next page.

Type of BIOS	Type of ROM chip	ROM Configuration	Jumper W7
DTK BIOS or any other of 64KB size	27256 x 2	U39 - High byte U40 - Low byte	1 
Other BIOS of 32KB size	27128 x 2	U39 - High byte U40 - Low byte	1 

**Table 2-4: Jumper Settings for Different Types of BIOS**





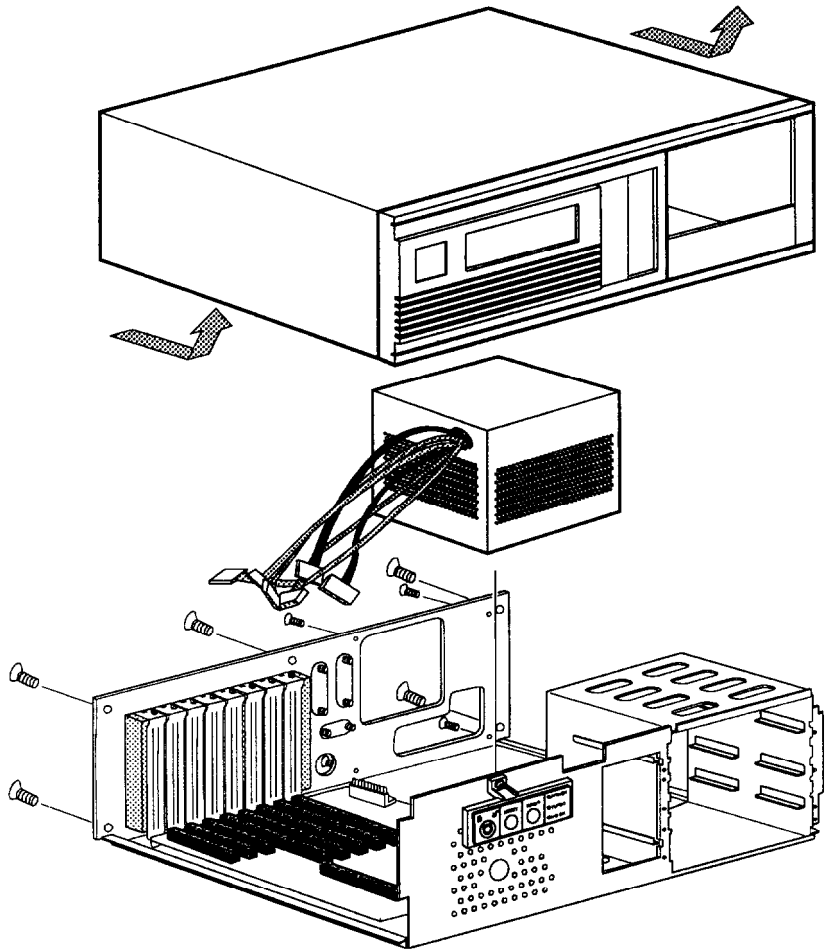
**Figure 2-15: Installing ROM**

If you are not sure what BIOS chips you have, you may need to consult your dealer for the right chips.

## 2-2 Installation

The time may come when you want to upgrade your system. To do so, you may need to remove the cover of the unit. This is easily accomplished with the following tools: a small flat-blade screwdriver and a small Philips screwdriver.

Be sure that the power to the system is switched OFF before you open the case. Your computer interior is as below:

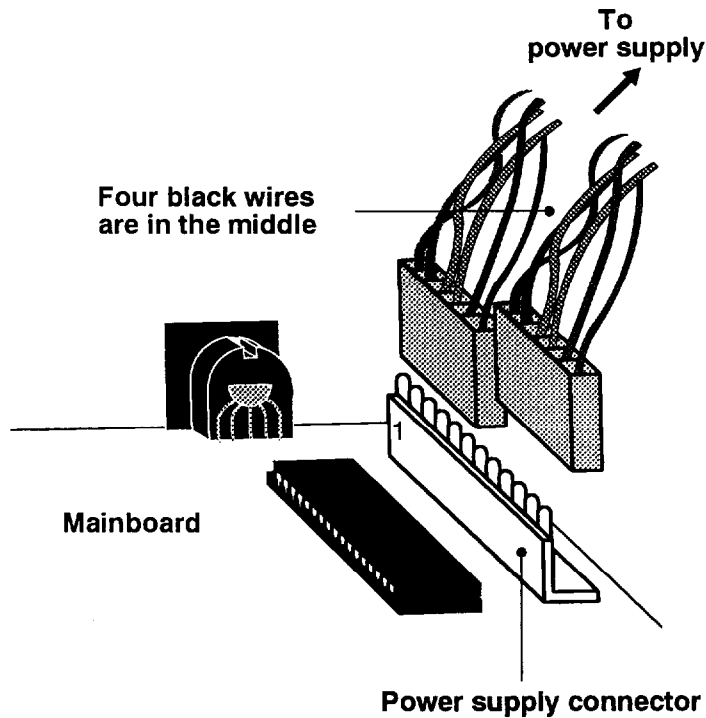


**Figure 2-16: Unpacking Your Main System**

## 2-3 Connection to Power Supply

If your power supply has not been attached to your motherboard, you may need to attach the power supply cable to the mainboard at connector J9, which is beside the power supply on the motherboard.

There are some cables on the power supply. Be sure the four black wires of the power supply cables are located at the middle of the power connectors. Refer to the figure below. Pin 1 is numbered in the picture for your convenience.

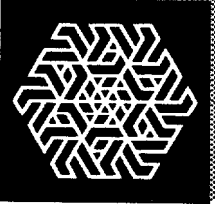
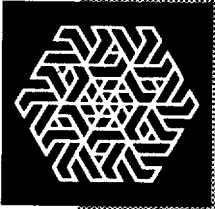
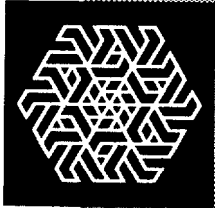
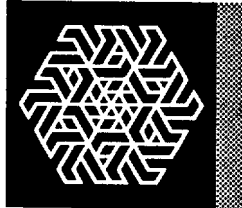


**Figure 2-17: Connecting to a Power Supply**

The pinouts for the connectors at J9 are as follows:

Pin	Assignment
1	Power Good
2	+5 VDC
3	+12 VDC
4	-12 VDC
5	Ground
6	Ground
7	Ground
8	Ground
9	-5 VDC
10	+5 VDC
11	+5 VDC
12	+5 VDC

***Table 2-5: Power Supply Pinouts***



# **Chapter 3**

## ***Operating Your System***

# Operating Your System

---

In this chapter you will learn:

- a few MS-DOS functions
- the basics of the system setup program

The software that your system will use falls into two categories. First there is the operating system, the language that tells the system what to do. The operating system in this computer uses is Microsoft Corporation's MS-DOS, the world's most widely used operating system for PC/XT/ATs.

Next, there is the application software what you use for work and play. Finding application software is a simple matter of going to your nearest PC store.

Note:

This is not an MS-DOS manual. It mentions only a few of the DOS functions available. To learn more about DOS, refer to your *MS-DOS User's Guide and Reference* manual included with your system.

## 3-1 An Introduction to DOS

---

DOS stands for Disk Operating System. This is a set of commands used to control the operations of a computer and its peripheral components. DOS makes it easy for you to use applications and create and manage files on your computer. DOS also lets you use devices with the computer.

### Loading DOS

---

Loading DOS means to copy all the DOS programs into the computer's electronic memory. You should follow the instructions below to start DOS.

#### **Starting DOS when the computer is off:**

- Insert DOS disk 1 into disk drive A and close the drive lever.
- Turn on the computer and respond to the prompts displayed on the monitor.

#### **Starting DOS when the computer is on:**

If you don't have a DOS disk in your disk drive when you start your computer, you will see the following message on the screen following the RAM test:

```
Non-system disk or disk error
Replace and strike any key when ready
```

Then, you should:

- Insert DOS disk 1 into disk drive A and close the drive lever.
- Press the reset button on your front panel (hardware reset) or hold down the <Ctrl>, <Alt> and <Del> keys at the same time (software reset) to reboot your system.

#### **Starting DOS from your hard disk:**

If you have a hard disk, install DOS on the disk. Your PC will boot automatically whenever you turn on the power.

### System Messages

---

Refer to your *MS-DOS User's Guide and Reference* manual for information on system messages.

## 3-2 DOS Operations

---

Following is a brief explanation of a few DOS functions. If you want a detailed explanation of all the DOS commands, refer to your DOS user manual.

### Starting MS-DOS

---

If you are using a hard disk with DOS already installed, the computer will “boot” or start itself.

If you are using a floppy disk drive, insert the DOS system disk in drive “A” and switch on your computer. You will see a message similar to the following:

```
Current date is Fri 01-01-1990
Enter new date (MM-DD-YY):
```

For the new date, key in the month, day and year, separated by hyphens. Press <Enter>.

Time is displayed and corrected as follows:

```
Current time is 0 : 02 : 15.00
Enter new time: 2:20
```

Your computer is now booted and ready to run application programs.



## Formatting Disk

---

You must format a floppy disk before it can be used.

### ***Formatting high-density disk:***

To format a high-density disk, type the following at the drive prompt:

```
C>Format A:      <Enter>
```

After your disk has been formatted, you will see the following prompt:

```
Format another diskette (Y/N)?
```

Press <N> if you do have nothing else to be formatted.

### ***Fomattting a low-density disk:***

To format a lowdensity disk, type the following at the drive prompt:

```
C>Format A:/4    <Enter>
```

After your disk has been formatted, you will see the following prompt:

```
Format another diskette (Y/N)?
```

Press <N> if you have nothing else to be formatted.

## **Backing up your Diskettes and Files**

---

In order not to lose your files through disk damage or accidental deletion it is important to back up all your files and diskettes regularly.

### ***Backing up a diskette on a two-floppy disk drive system:***

At the A> prompt type the following

```
A> diskcopy a: b:
```

Press <Enter> and respond to the prompts on your screen.

### ***Backing up a diskette on a single floppy disk drive system:***

At the A> prompt type the following-

```
A> diskcopy
```

Press <Enter> and respond to the prompts on your screen.

After your target disk has been copied, you will see the following prompt:

```
Copy another diskette (Y/N)?
```

Press <N> if you have nothing else to be copied.

### ***Backing up a file:***

To back up a single file, key in the backup command and directory as follows:

```
A>backup <path> <filename> <drive>/A
```

## Deleting your Diskettes and Files

---

You may want to erase diskettes or unnecessary files to make room for other data.

### ***Erasing a diskette:***

To erase a whole directory of files, type the following at the drive prompt:

```
A>del *z*      <Enter>
```

All the files in the open directory are now erased.

### ***Deleting a file:***

To delete a single file, type the following at the drive prompt:

```
A>del filename.ext  <Enter>
```

## Finding Out What is on Your Disk

---

If you want to find out what files are on a disk, you can list its directory by using the `<DIR>` command. If you want to display the directory of the disk in drive A, you would use the following command:

```
DIR A:
```

After you hit the enter key, all the file information will display on the screen.

If you use the `<DIR>` command without a drive letter, MS-DOS lists the directory of the disk in the default drive.

There are three ways to stop the screen from scrolling.

- Ž pressing the `<Ctrl>` and the `<S>` keys simultaneous
- Ž pressing `<Pause>`
- Ž typing `DIR/P` to see one screen each time

### 3-3 Hard Disk Drive Format

---

A hard disk must be formatted before it can be read from or written to. If your hard disk requires this, you should carry out the following steps:

#### **Step 1 — Preformat**

---

The preformat utility is supplied by the system BIOS. You can press <Esc> key quickly just after the RAM test to enter the SETUP program. Choosing item 2 from the initial screen to preformat hard disk. See Figure 3-1.

#### **Step 2 — Partition**

---

This process creates DOS partitioning on a preformatted hard disk drive. The DOS command “FDISK” handles this partitioning process.

Insert your DOS diskette in drive A and type a: to get A prompt. Then type:

```
A> FDISK < ↵ >
```

The “FDISK” command displays a serial of menus to help you partition your hard disk for MS-DOS. With the “FDISK” command, you can:

- create a primary partition,
- create an extended partition,
- change the active partition,
- delete an partition,
- display partition data, and
- select the next fixed disk drive for partitioning on a system with multiple fixed disks.

If your hard disk is 40MB, you may have partitions of up to 33MB in size. 33MB is the maximum space for a partition allowed by DOS.

For more information about how to use creating DOS partition, see *Appendix D* in *MS-DOS User's Guide and Reference*.

### Step 3 — Format

---

The DOS command "Format" verifies the media and moves the system file onto the hard disk drive. The command should be keyed in as:

```
A> FORMAT C:/S
```

if you have two partition, you have to format D in DOS prompt. The command should be keyed in as:

```
A> FORMAT D:
```

If you want to use the partition 1 (drive C) to start DOS, you have to specify the /S option when formatting the disk. You can use this system disk to boot your system later.

Note that you don't need to perform this procedure if you want to use new partition for other operating systems like Xenix, Novell or Unix. Refer to their manuals for details.

### 3-4 Helpful Hints

---

The following may save you some time or help you as you use your computer.

- Ž Make copies of your diskettes regularly.
- Ž To make sure that a command works, you should:
  - Check your typing (make sure you don't confuse \ with /).
  - Have the correct diskette in the drive.
  - Check the contents of the diskette with the *DIR* command.
  - Specify the correct diskette drive.
  - Remember to include the colon (:) when specifying the name of a drive.
  - Spell the filename correctly
  - Use the appropriate extension (such as \*.DOC or \*.EXE)
- Ž Refer to the DOS Reference for additional information if a command still doesn't work.
- Ž Print contents of a disk (if you have a printer) and keep the list with the diskette.
- Ž All commands (except DISKCOPY and DISKCOMP) are files that will work on both diskettes and hard disk drives.
- Ž The date and time shown with each directory entry are the date and time of the last addition or change to that file. The date and time are not changed during a COPY or a DISKCOPY.

### 3-5 System Setup Program

---

A system setup program is included in your BIOS on the motherboard. The setup program is used to key in the configuration you want for your system. Specifically, you can set the date, time, base memory, expansion memory, number of floppy and hard disk drives and display configuration as well as get information on hard disk types.

Your system BIOS is fully compatible with IBM BIOS. In addition, many special functions are supported like:

- Ž a low-level fixed disk format utility
- Ž three system utilities (a calculator, a hard disk park, and a timer)
- Ž system password
- Ž user-defined hard disk types
- Ž NEAT chip set

The setup program is simple to be used. It is extremely important that you respond correctly to the prompts about your computer.

The following will guide you through the setup program. For more information about the setup program, refer to your BIOS manual.



## Entering the Setup Program

There are two ways to enter the setup program: by pressing <F1> or by pressing <ESC>.

### 1. Pressing <F1> to Enter the Setup Program

You will need to press <F1>, to enter the setup program in the following situations:

- Ž when your computer is turned on for the first time
- Ž when the rechargeable battery is dead
- Ž when the hardware configuration is changed

If the battery for CMOS chip is dead or the system configuration does not match your actual hardware configuration, you will have to reconfigure your system. The computer will give you this screen message:

Press the F1 key to enter the setup program or  
press any other key to continue

Under the above three conditions, pressing <F1> will automatically start the setup program.

Under any conditions within DOS, you can use the DOS DEBUG command as follows:

```
A> DEBUG ↵  
-g=F000:FF60 ↵
```

This command will start the setup program.

## 2. Pressing <ESC> to Enter the Setup Program

If you want to set up special functions provided by BIOS or reconfigure your system, you will need to enter the setup program. After starting your computer, press the <Esc> key quickly before the RAM test finishes. If you miss the chance to do so, reset your system and repeat the above procedures to enter the setup program. Before the setup program appears, the following message will appear on the screen:



SETUP utility will be starting

When the system self test is completed, the setup program will take over.

Once you have entered the setup program, you will see the following initial screen:

---

ROM SETUP PROGRAM VERSION 2.0  
(C) COPYRIGHT DATATECH ENTERPRISES CO., LTD 1990.  
ALL RIGHTS RESERVED.



**1. SET UP SYSTEM CONFIGURATION.**

2. PREFORMAT HARD DISK.

3. SET UP BUILT-IN UTILITY.

4. SET UP PASSWORD.

5. SET UP USER-DEFINED HARD DISK TYPE.

6. SET UP NEAT CHIP SET.

9. QUIT SETUP PROGRAM.

CHOOSE ITEM NUMBER : [1]

**Figure 3-1: Initial Screen**

## Running the Setup Program

---

The menu of the setup program highlights the selected command. You can use the up < ↑ > and down < ↓ > arrows to select the desired item. Pressing the enter key < ↵ > confirms your selection or enters the next screen. If the option on the screen does not match your configuration, you have two ways to make modifications. You may either highlight selections and press < ↵ > to enter the command or use the left < ← > and right < → > arrows to show different options and select from them.

If you want to exit a current screen, you may press < Esc > or select the exit item of the screen.

The following are some examples of setup program screens you will see in using the program.

## 1. Setting Up System Configuration

If you choose item 1 from the screen on the previous page to configure your system, the following will appear:

ROM SETUP PROGRAM VERSION 2.0  
(C) COPYRIGHT DATATECH ENTERPRISES CO., LTD 1990.  
ALL RIGHTS RESERVED.

```

                SET UP SYSTEM CONFIGURATION
1. CURRENT DATE : [04-26-1990]
2. CURRENT TIME : [ 05:30:00 ]
3. COPROCESSOR  : [    1    ]
4. BASE        MEMORY : [  640 KB]
5. EXTENDED    MEMORY : [ 1280 KB]
6. DISKETTE DRIVE A : [ 1.2 M ]
   DISKETTE DRIVE B : [  NO  ]
7. FIXED DISK TYPE C : [ 40 / MFMM ]
   FIXED DISK TYPE D : [ NO / NONE ]
8. PRIMARY DISPLAY CARD : [  MGA  ]
9. EXIT

        CHOOSE ITEM NUMBER : [ 1 ]
-----
↑↓:CHANGE ITEM  ←→:MODIFY  ↵:ACCEPT
```

**Figure 3-2: "Set Up System Configuration" Screen**

Once you have entered all appropriate information and exited by choosing item 9, you will be asked to confirm that the configuration data are correct.

If at a later date you alter the configuration of your system, you will need to go through the program again and make the appropriate changes.

## 2. Preformatting Hard Disk

If you want to preformat your hard disks, reenter the setup program by pressing <Esc>, and select item 2 on the initial screen. The program will then proceed as below:

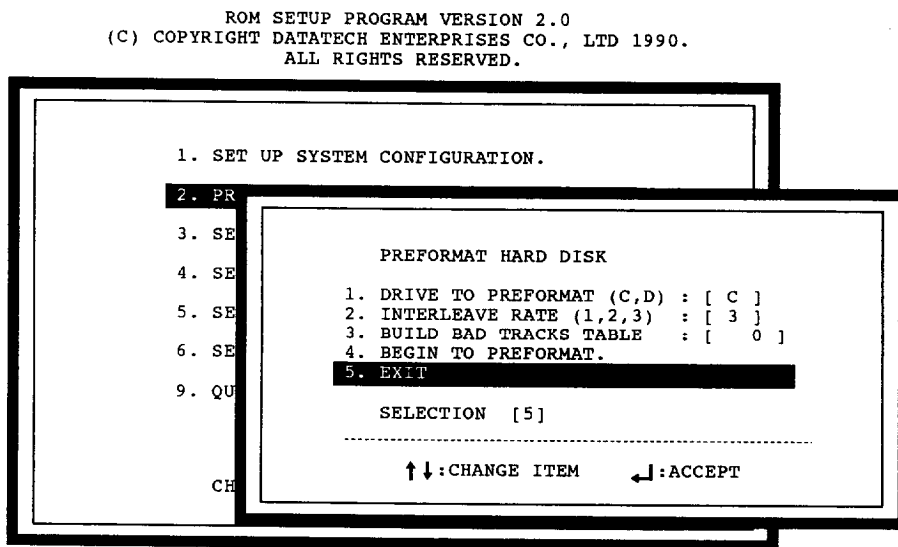


Figure 3-3: "Preformat Hard Disk" Screen

### 3. Setting Up Built-in Utilities

Three system utilities, a calculator, a hard disk park, and a timer, are in your system BIOS. These utilities are enabled by the setup program. Note that these utilities can be used in the SO-column text display mode only.

The calculator and the hard disk park can be used if you press <Ctrl>, <Alt>, and <5> (on the key pad). Pressing <Esc> will exit these Utilities. The following is the figure for the calculator.

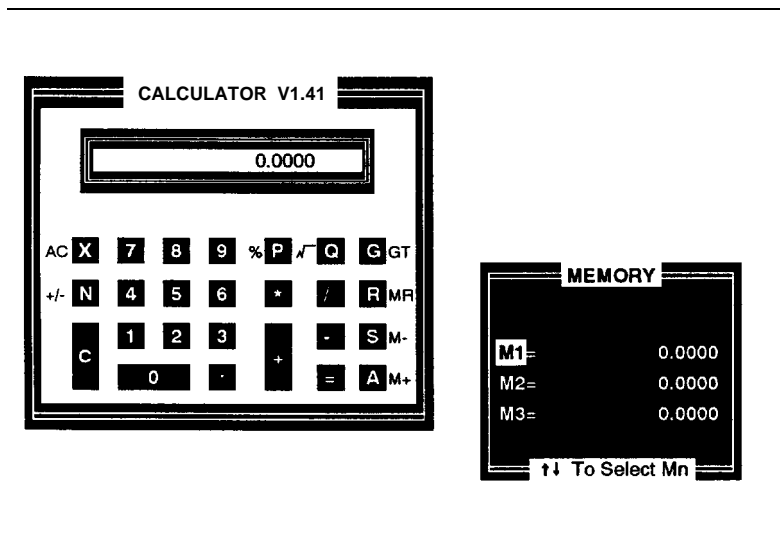


Figure 3-4: Calculator

#### 4. Setting Up Password

Selecting item 4 in the initial setup menu will lead you to set up a system password. A password can deny unauthorized users access to the computer. You can key in a password with a maximum of seven alphanumeric units,

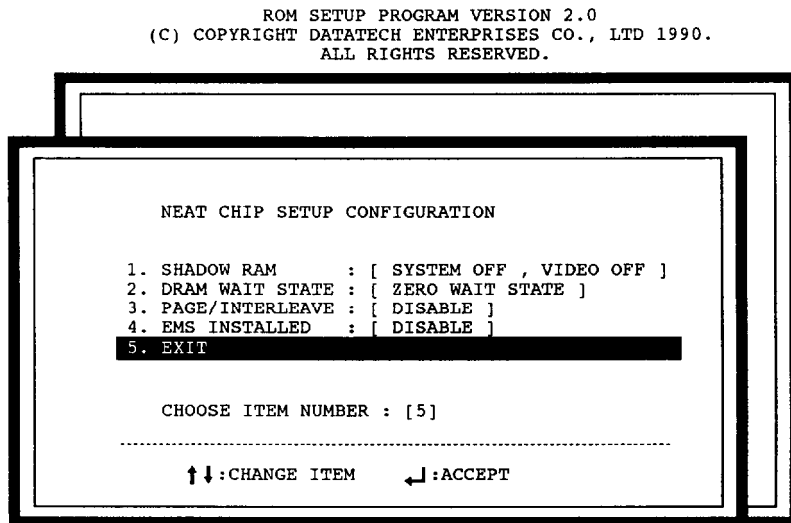
You may press <F1> to see the present password status.

#### 5. Setting Up User-Defined Hard Disk Type

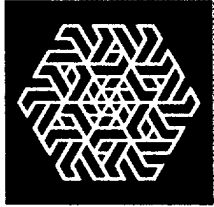
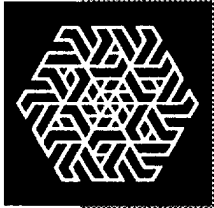
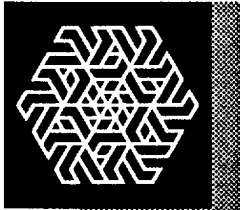
If none of the drive types (1-47) match the fixed disk drive specifications you have, select item 5 in the setup menu to set a user-defined hard disk type.

#### 6. Setting Up NEAT Chip Set

Choose item 6 in the setup menu to select a chip set configuration. The screen will show as below:



**Figure 3-5: “NEAT Chip Setup Configuration” Screen**



# ***Chapter 4***

## ***Keyboard***



In this chapter you will learn:

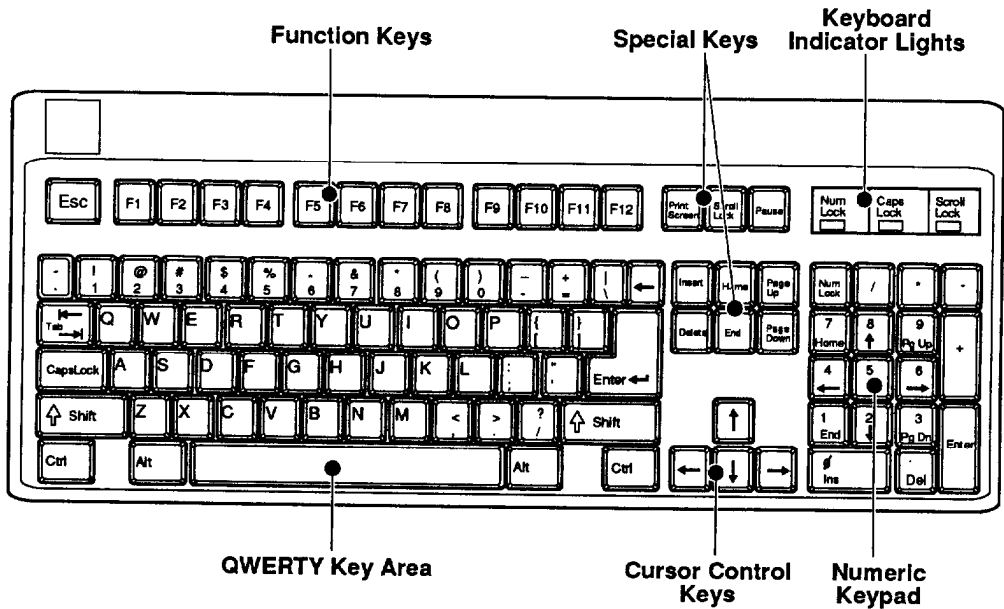
- the basics of your keyboard and its functions
- how to adjust your keyboard angles

A computer keyboard sends messages from you to the computer. It has:

- QWERTY keys
- Function keys
- Cursor control keys
- A numeric keypad
- Special keys
- Keyboard indicator lights

## 4-1 Keyboard Layout

Currently several of keyboard styles are available for PC/AT/XT compatible computers. The most popular are the PC keyboard, the PC/AT keyboard, and the enhanced keyboard. Figure 4-1 below illustrates the basic layout of a typical enhanced keyboard.



*Figure 4-1: Keyboard Layout*

## 4-2 Getting Acquainted with Your Keyboard

---

Before you begin using your computer, you should become familiar with some keyboard functions. Your keyboard is divided into six sections. Refer to the previous page for the layout. The following gives an explanation of these keys.

### Function Keys

---

These are located on the left or at the top of the keyboard. Function keys have specially defined uses preassigned by the software you use. They are used independently or in combination with other keys.

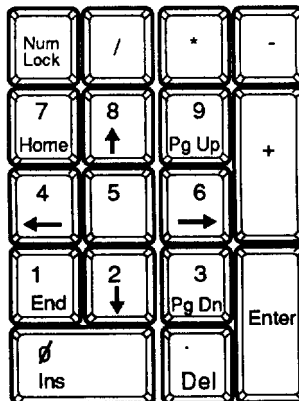


*Figure 4-2: Function Keys*


















### Numeric Keypad

---

This is located on the right of the keyboard. At the center of the keypad are nine numeric keys. These keys are used to move the cursor as well as to enter numbers when either the Caps Lock key or Num Lock key is pressed. Refer to the figure below:



*Figure 4-3: Numeric Keypad*

Keys	Function
	Turns on and off the numeric mode on the numeric keypad.
	Used for division operations.
	Used for multiplication operations.
	Used for subtraction operations.
	Activating Num Lock makes 7 operative. Home returns cursor to the beginning of the line it is on.
	Activating Num Lock makes 8 operative. Otherwise the up cursor key is active.
	Activating Num Lock makes 9 operative. Otherwise page up is active.
	Used for addition operations.
	Activating Num Lock makes 4 operative. Otherwise the cursor key is activated.
	Activating Num Lock makes 5 operative.
	Activating Num Lock makes 6 operative. Otherwise the cursor key is activated.
	Activating Num Lock makes 1 operative. Otherwise end moves the cursor to the end of the line it is on.
	Activating Num Lock makes 2 operative. Otherwise the cursor key is activated.
	Activating Num Lock makes 3 operative. Otherwise page down is activated.
	Activating Num Lock makes 0 operative. Otherwise the key functions to insert characters at the position of the cursor.
	Used for decimal points. Otherwise it deletes characters where the cursor is positioned.
	Enters commands or inserts invisible paragraph characters.

**Table 4-1: Function of Numeric Keypad Keys**

## Mode Indicator Lights

In addition to the character, number and control keys, every keyboard has three lights that indicate the typing mode. These lights and their functions are explained as follows:



**Figure 4-4: Indicator Lights**

### ***Caps Lock***

When this light is on, characters are in uppercase mode.

### ***Num Lock***

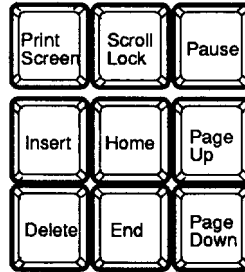
When this light is off, the cursor-control function of the numeric keypad is disabled and the numeric mode is activated.

### ***Scroll Lock***

When this light is on, text can be scrolled without moving the cursor.








## Special Keys

Below are some special keys on your keyboard.



**Figure 4-5: Special Keys**

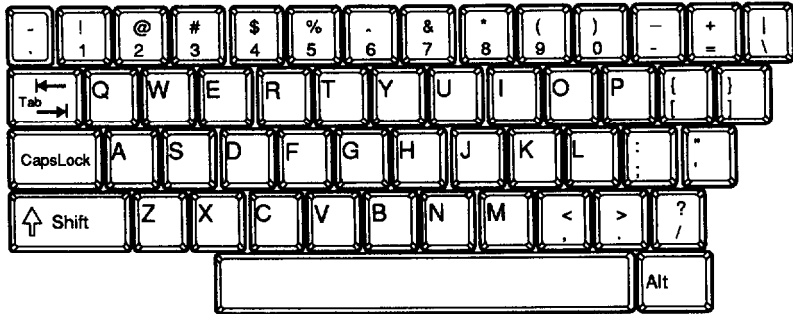
Check out the above key functions in the table below and in Table 4-1.

Keys	Function
	Pressing this key together with the shift key will print all data on the screen.
	With Scroll Lock activated, you can move text vertically in line units.
	Pressing this key halts the current operation; pressing it again allows the operation to continue.
	Moves the cursor for corrections, but the line is not deleted from memory.
	Skips to new line.
	Used with alphanumeric keys to enter BASIC key words.
	Used with another key to execute a command.





**Table 4-2: Functions of Special Keys**

## QWERTY Keys

These are the same keys which are used on a typewriter.



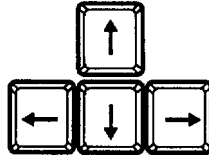
*Figure 4-6: QWERTY Keys*

Keys	Function
	Performs a tab function similar to that of a typewriter.
	Changes lowercase letters to capitals.
	Moves cursor back one space and erases characters.
	Pressing this key activates uppercase letters; pressing it again activates lowercase letters.

*Table 4-3: Functions of Special QWERTY Keys.*

## Cursor Keys

These keys move the cursor in the indicated direction.



*Figure 4-7: Cursor Keys*

## Key Combinations

The keys shown below have special functions when pressed simultaneously.

Keys	Function
Ctrl + Break or Ctrl + S	Both keys used together stop a program while it's running. Pressing any key again allows you to continue.
Ctrl + C	Both keys used together interrupt a program while it's running and identify line where it stops.
Ctrl + Alt + Del	These three keys reset the system so that the machine is at the RAM test stage.

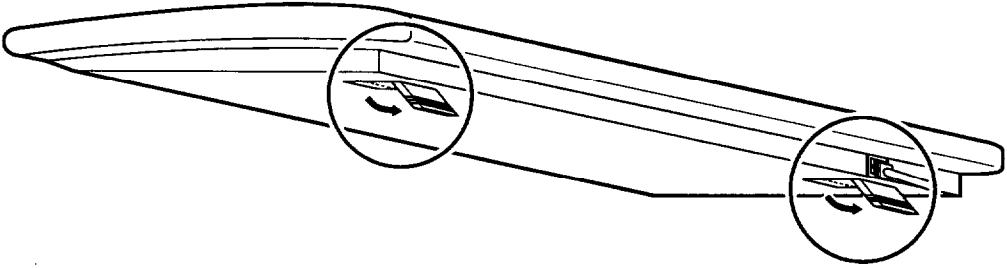
*Table 4-4: Special Functions*



### 4-3 Keyboard Tilt Adjustment

---

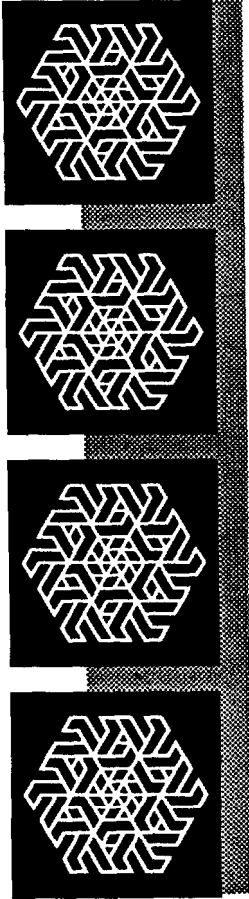
Under the rear of the keyboard are two small legs that can be pulled out or pushed in to change the keyboard angles to suit you.



**Figure 4-8: Adjustment of Keyboard Angles**

# **Chapter 5**

## ***Troubleshooting***



# Troubleshooting

---

In this chapter you will learn about:

- the basics of how to solve software/hardware problems
- when to get technical help for your computer

Your computer has been designed to last for years of optimum performance. But if some problems do occur, more likely than not you will be able to solve them by referring to this chapter.

No matter whether you are a new or experienced user, you should become familiar with the material in this chapter. For detailed explanations of computer problems and how to solve them, you are urged to buy personal computer troubleshooting books from your nearest hardware or software dealer.

## 5-1 Command Problems

---

Often what appears to be a big problem is in fact just a matter of a small Oversight. Before taking your computer to the shop for major surgery, check the following items:

- Make sure that all devices (computer and peripherals) have power and are turned on.
- If you encounter a problem while you are working, stop what you are doing immediately.
- On paper, make notes of what is happening. List the actions you have taken and the responses from the computer. You may want to print a copy of the screen by using the <Shift> + <PrtSc> keys combination.
- Use the diagnostic software on your computer. Try to find out the conditions under which the malfunction occurs. Try also to isolate where the problem is occurring. Is it with a certain software program or with your hardware? If the problem is with software, you should probably talk to your software dealer. If the problem is with the hardware, try to narrow down the source of the problem. Is it your disks or disk drives? Keyboard? Printer? Screen?
- If some messages appear on the screen, refer to your MS-DOS manual for an explanation of the message. You may want to write down the message or print it out with the <Shift> + <PrtSc> key combination. Problems (except blackouts) can be avoided if you run your system on a dedicated electrical line. That is, ensure that your computer and peripheral electric cords are not shared by other appliances such as a refrigerator or air conditioner. Also, it is highly advisable to purchase a surge suppressor. This is a set of electric sockets enclosed in a single housing. A surge suppressor prevents sudden pulses of high electric power (spikes) from damaging the computer. This appliance is inexpensive and can be purchased at any computer or electronic hardware store.

- Are you using a startup disk?
- Is your disk formatted?
- Is the system configuration correct?
- Are all the external and internal connectors are connected well?
- Make sure that you are running software compatible with your display port, because some softwares program can only run on the MGA display mode.
- Is the power fuse burned out?

If you have gone through the above checklist and your system still does not function properly, check the following pages. The following instructions will help you solve some common problems. However, you should be aware that other problems might stem from system software, applications or other peripherals.

## 5-2 System Error Messages

---

Basically there are three levels of system error messages that you might see displayed on your computer. These are related to the software you use. The following are the ones most commonly encountered.

### ***Software error messages are a result of:***

- Ž **Software lockup**; the application becomes stuck and the cursor will not move. When this happens, remove your application program from the disk drive (unless a hard disk is used) and reboot your computer. If the problem persists, contact your nearest software dealer.
- Ž **Software crash**; the application suddenly displays garbled text on the monitor or the cursor locks up. Try to reboot the computer. If the problem persists, you will need to contact the software dealer from whom you purchased the package. He/she should replace the package, depending on the service contract, or have it repaired.

### ***Hardware error messages:***

These messages are related to the computer's internal components, your monitor, mouse, or printer. Hardware problems are usually ones that the user cannot solve alone. Professional services are therefore required.

### ***Error messages generated by MS-DOS, BASIC or other high-level applications:***

These messages relate to problems due to incorrect use or malfunction of a high-level application under which you might run your software. It is still advisable to contact your software dealer for assistance with such problems.

Consult your dealer if you have any questions about troubleshooting.

## Examples of System Error Messages

---

### ***System crash***

The cursor cannot be moved and does not respond to the keyboard. This could indicate a software crash. Mark where you are in your document. Reboot your system and reload your software. Scroll the cursor to where you last saved your data. Retype the information up to where the cursor could not be moved. Enter the rest of the data. If the cursor continues to function normally, the problem was probably caused by accidentally pressing the wrong key. If the problem occurs again, go over the same procedure. If the problem persists, contact your software dealer.

### ***System does not boot***

This can be caused by defective hardware or a faulty system disk. Turn off your computer and try again. If unsuccessful, try using your backup system disk because your working disk may be damaged. If the problem persists, you might have a hardware problem. You should contact the dealer from whom you purchased your computer.

### ***Monitor displays garbled, unrecognizable Characters on the screen***

This usually indicates the monitor is set to an incorrect baud rate. Ask your computer dealer the correct baud rate for the computer's output board. Locate the baud rate switches on your monitor and reset the baud rate.

## 5-3 System BIOS Error Messages

---

### ***ROM BIOS Checksum Error***

- Indicates an invalid ROM BIOS failure.

### ***8254 Error***

- Indicates an 8254 timer controller failure.

### ***8237 Error***

- Indicates an 8237 DMA controller failure.

### ***74612 Error***

- Indicates a 74612 page register failure.

### ***8259 Error***

- Indicates an 8259 interrupt controller failure.

### ***8742 Error***

- Indicates an 8742 controller failure.

### ***Check Battery***

- Indicates a system backup battery disconnection or power loss.

### ***RTC Checksum Error***

- Indicates that the system memory refresh function does not work.

### ***Refresh Indicator Error***

- Indicates that the system memory refresh does not work.

### ***Base 84K Memory Error***

- Indicates that the system's first 64K memory does not work.

### ***FDC Error User Check***

- Indicates that the floppy diskette controller does not work.

### ***FDD Seek Failure***

- Indicates a failure of the floppy diskette drive "seek operation.



**Keyboard Error User Check**

- Indicates the disconnection of the keyboard from the system or a keyboard device failure.

**Parity Error but Segment not Found, Press any Key to Continue**

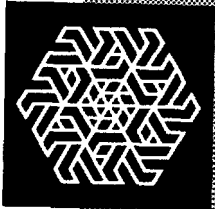
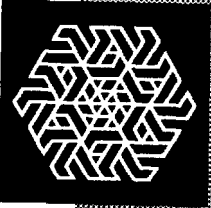
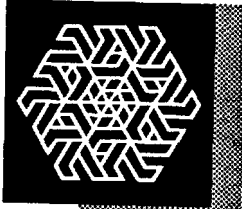
- Indicates that the NMI circuit has detected a RAM parity error.

**System Memory Mismatch, Run SETUP**

- Indicates a mismatch of memory size in the CMOS RAM and onboard. You need to run the setup program.

**Display Card Mismatch, Run SETUP**

- Indicates a mismatch of a record in the CMOS RAM and onboard. You need to run the setup program.



***Chapter 6***  
***Appendix***

This chapter provides:

- technical information
- jumper settings in your system
- information on moving your computer

This manual is not a technical reference manual; however, this chapter provides some technical information about your system. If you need more information, you can go to a technical library or bookstore to find technical reference books.

## 6-1 Installing Disk Drives

---

Three 5.25" floppy/hard disk drives and two 3.5" floppy/hard disk drives may be installed in the system unit. Installation of a hard disk is essentially the same as that for a floppy disk.

You may at sometime want to add to or exchange your floppy or hard disk drives. Follow the instructions below to do so.

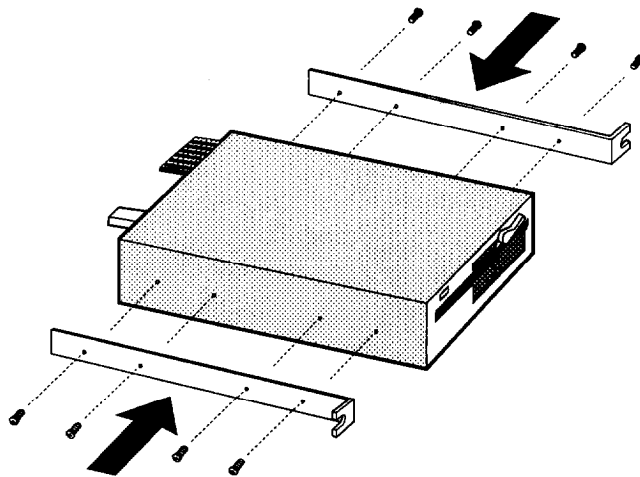
Be certain to refer to the manuals for both the disk drive and the controller card for any additional specific information regarding them that may be of importance.

### 5.25" Disk Drives

---

To install or remove 5.25" disk drives, follow the steps below:

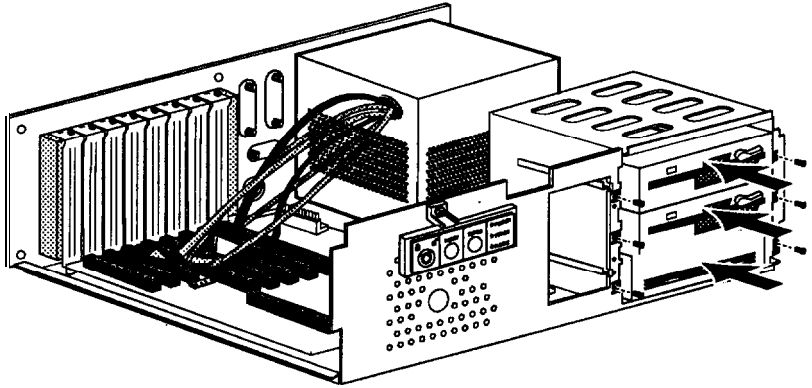
- Open the system unit case as described on Figure 2-16.
- Screw the metal guides to the disk drive as shown below:



**Figure 6-1: Installing a 5.25" Disk Drive**

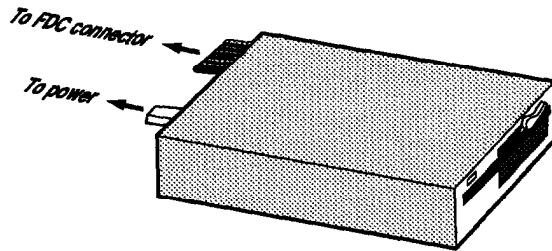
Slide the back end of the disk drive first into the disk drive bay.

- Screw the disk drive to the disk drive bay as shown below:

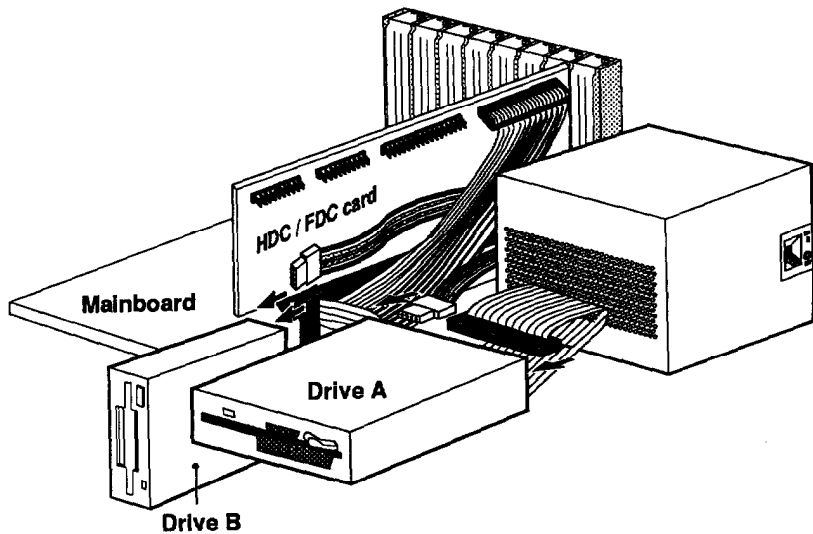


**Figure 6-2: Screwing the 5.25" Disk Drives**

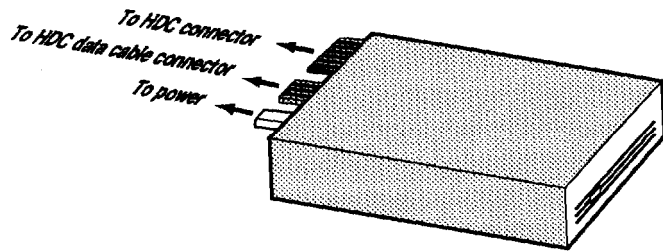
- Next, connect the floppy/hard disk controller cable and one of the four cables from the power supply. The power cable is simple to connect: simply plug it in to the correct adapter. The shape of the plug ensures that no mistakes will be made. See the figures on the following pages.



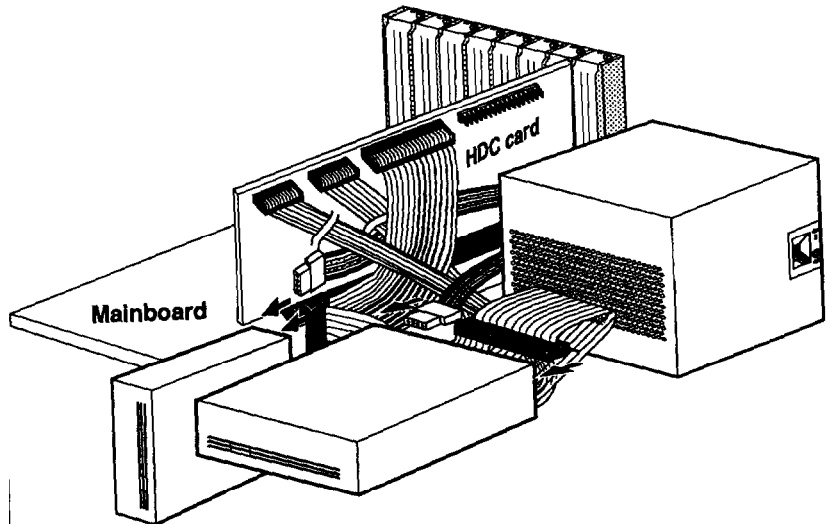
**Figure 6-3: Connecting a Floppy Disk Drive**



**Figure 6-4: Connecting a Floppy Disk Drive to an FDC Card**

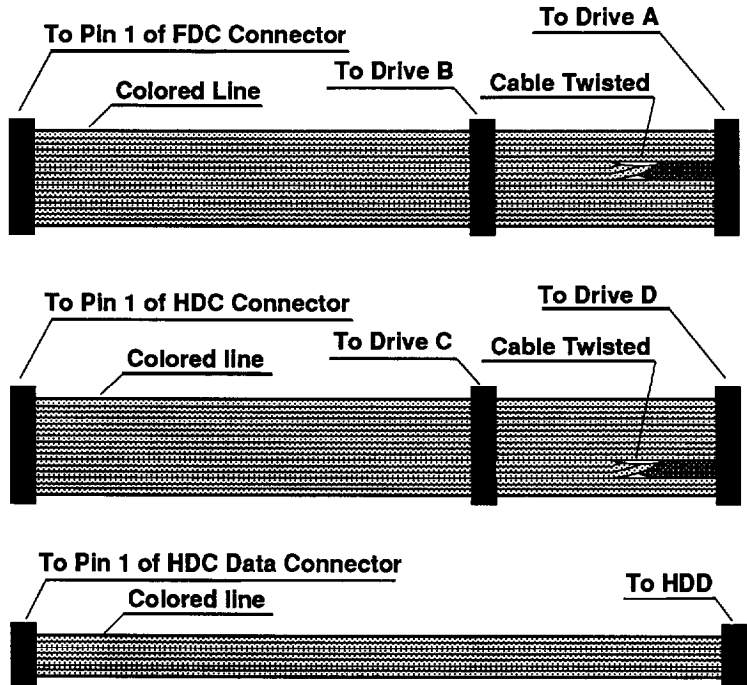


**Figure 6-5: Connecting a Hard Disk Drive**



**Figure 6-6: Connecting a Hard Disk Drive to an HDC Card**

- One edge of the ribbon cable is marked with a color line. This specific line side of the connector should be at pin 1 when attached to the card. Pin 1 is clearly marked on the card. See the figure below:



**Figure 6-7: Cables for Disk Drives**

Follow the same procedure for any additional drives you want to install.

### **Removal**

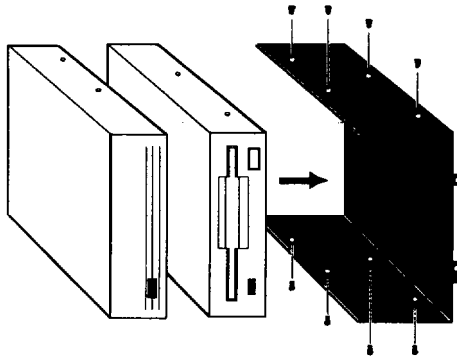
To remove a drive, just reverse the procedure described above. Disconnect the cables, undo the screws and slide the drive out.



### 3.5" Disk Drives

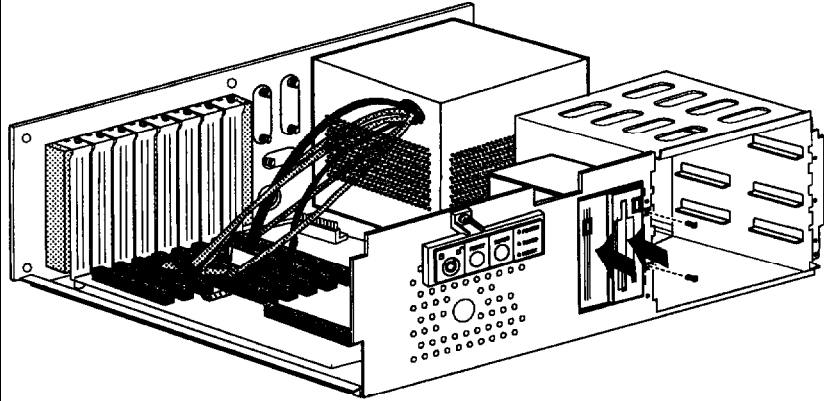
The installation of a 3.5" disk drive is similar to that for a 5.25" disk drive. Follow the steps below:

- Fasten the drive to the bracket as follows:



**Figure 6-8: installing a 3.5" Disk Drive**

- Ž Place the disk drive inside the bay and fasten the bracket to the chassis.  
Refer to the figure on the next page.



**Figure 6-9: Screwing the 3.5" Disk Drives**

Connect the power cable and the hard disk controller cables. Note that there is only one possible way to connect the power cable and hard disk cables owing to the shape of the connectors, so it is impossible to make a mistake.

The two hard disk controller cables are of different sizes: the red wires on the cables should be connected so that they are toward the central portion of the case.

### **Removal**

To remove a 3.5" disk drive, reverse the procedure described above. Disconnect the cables, undo the mounting screws, slide the drive out and remove the mounting guides.

## 6-2 Entering 20MHz Turbo Mode

---

The main advantage of your mainboard over ordinary PC/AT mainboards is its dual clock system. This innovation makes it possible for your computer to operate at either of two clock speeds: 10MHz or 20MHz.

### Entering 20MHz Turbo Mode

---

Your system supports both a software and hardware switch to toggle between 10MHz and 20MHz (Turbo) modes. The two switches are set up using jumper J3 and are mutually exclusive. You must choose either software or hardware if you are setting up the board yourself.

### Software Turbo Switch

---

When jumper J3 is covered with a jumper cap or is connected to a closed hardware Turbo switch, the speed can be toggled between Turbo and Normal from the keyboard. The clock speed when you turn the system on will be 10MHz (or 20MHz). To switch the speed to 20MHz (or 10MHz), do the following: press and hold down the control <Ctrl> and alternate <Alt> keys on the keyboard while you press the minus <-> key. The Turbo LED on your panel, if you have one, will light. For more information on the Turbo LED, refer to the Connectors section.

### Hardware Turbo Switch

---

If your hardware Turbo switch is connected to pins one and two of jumper J3, pushing the switch on and off will toggle between 10MHz Normal mode and 20MHz Turbo mode.

### Alternate Use of Both Switches

---

Both the hardware and the software switches may be used alternatively, but this is not advised because you may become confused about the mode of operation. When using both switches alternatively, the Turbo LED will be the only accurate indicator of the actual mode: the LED will be on in Turbo mode and off in Normal mode.

Your system supports shadow RAM and Expanded Memory System (EMS) to increase the system memory capability.

Note that If you have more than one megabyte memory, you may enable or disable the 384K memory as shadow RAM. The 384K is always allocated at the same address for shadow RAM, even if you disable the shadow RAM.

**Important:**

You can only enter the setup program by pressing <Esc> when the power is just switched on. You may reset the system to enter the setup program, too.

**Shadow RAM Enable**

---

For efficient execution of BIOS, it is preferable to run BIOS code through RAM rather than through the slower EPROMs. Your system can support shadow RAM for BIOS and video.

To enable shadow RAM, follow the steps below:

- Hold down the <Esc> key to enter the setup program as you turn the power on.
- Select item 6 to enter the NEAT Chip Setup Configuration menu.
- Select item 1 to enable BIOS or video shadow RAM. (Refer to the BIOS manual for details.)

**EMS Driver Setup**

---

The mainboard supports LIM 4.0 EMS. To set up the EMS driver, follow the steps below :

- Hold down the <Esc> key to enter the setup program. Choose item 6 to enter the NEAT Chip Setup Configuration menu. From this menu, you may enable EMS and select EMS size. (Refer to the BIOS manual for details.)

**Note:**

If you only have one megabyte onboard memory, you must disable the shadow RAM function first in order to use 384K extended memory as expanded memory.

- Insert the EMS driver diskette into drive A and enter a: .
- Enter this command:  
INSTALL

You will see the following screen.

```
This program installs the NEAT EMS driver on your hard disk.  
(Press Esc key to quit: any other key to continue installation)
```

- The next screen will be as below if you continue setup.

```
Enter the path name for the location of NEMM.SYS:  
C:\NEMS  
(Press Esc key to quit: any other key to continue installation)
```

Indicate the path name where NEMM.SYS is to be located. If you want the program to create a directory with the default name (NEMS) on your hard drive, press the <Enter> key. Otherwise, type in the path and directory name of your choice

- A screen like the following will appear.

DTK NEAT EMS hardware configuration setup. Select the option you want for each item	
<p><b>PAGE REGISTER I/O : 0</b>  <b>BASE ADDRESS</b></p> <p>FRAME START ADDRESS:4</p> <p>F1:accept, Esc, ↑ ↓</p>	<p>0: 208H/209H            1: 218H/219H            2: 258H/259H            3: 268H/269H            4: 2A8H/2A9H            5: 2B8H/2B9H            6: 2E8H/2E9H</p>

Indicate two parameters for EMS-page register I/O base address and frame start address.

- Choose the correct configuration as you desire, then press <F1> to complete setup.

You will get a warning if you give an incorrect response. For example, if you give D000H as your frame start segment, and shadow RAM in the same area, the following message will appear.

DTK NEAT EMS hardware configuration setup. Select the option you want for each item	
<p>PAGE REGISTER I/O : 0          BASE ADDRESS</p> <p><b>FRAME START ADDRESS:4</b></p> <p>F1:accept, Esc, ↑ ↓</p>	<p>0: C000H, C400H, C800H, CC00H            1: C400H, C800H, CC00H, D000H            2: C800H, CC00H, D000H, D400H            3: CC00H, D000H, D400H, D800H            4: D000H, D400H, D800H, DC00H            5: D400H, D800H, DC00H, E000H            6: D800H, DC00H, E000H, E400H            7: DC00H, E000H, E400H, E800H            8: E000H, E400H, E800H, EC00H</p>
<p><b>Cannot use as frame! This address is allocated for          Shadow RAM or ROM enable!</b></p>	

- If the installation is complete, the following will appear:

The installation is complete. Remove the diskette and press Ctrl+Alt+Del to restart the system.

- Reboot your system. The screen will look like this:

DTK NEAT Expanded Memory Manager Ver. 1.10 1990  
(C) Copyright Datatech Enterprise Co.,Ltd  
All Rights Reserved  
# 11060790

User specified PAGE PORT = 208H  
User specified PAGE FRAME = D000H  
Test Expanded Memory Page 128  
There are 128 PAGEs for EMS.  
NEMM.SYS has been installed.

## 6-4 Quick Reference for Jumper Settings

---

### ***W1 - W6 — Bank Selection***

***1 & 2 shorted — One or two RAM banks***

***2 & 3 shorted — Three or four RAM banks***

### ***W7 — ROM Selection***

***1 & 2 shorted — 27256 chip selected***

***2 & 3 shorted — 27128 chip selected***

### ***W8 — Pipeline***

***1 & 2 shorted — Pipeline disable***

***2 & 3 shorted — Pipeline enable***

### ***W9 — 80387SX***

***1 & 2 shorted — Coprocessor enable***

***2 & 3 shorted — Coprocessor disable***

### ***W11 — Power Good Selection***

***1 & 2 shorted — Onboard***

***2 & 3 shorted — External***

### ***W12 — Display Mode***

***1 & 2 shorted — Mono***

***2 & 3 shorted — Color***

### ***W13 — Battery Selection***

***1 & 2 shorted — External***

***2 & 3 shorted — Onboard***



***J1 — CPU Frequency indicator***

***J2 — Keylock & Power LED***

***J3 — Turbo Switch***

***J4 — Speaker***

***J5 — Turbo LED***

***J6 — Hardware Reset***

***J7 — External Battery Connector***

***J8 — Keyboard Connector***

***J9 — Power Connector***

## 6-5 Moving Your Computer and Peripherals

---

Your personal computer and its peripheral components are highly sensitive machines that can be damaged easily through bad shipping and handling. We recommend that you take the following steps before moving the equipment to another location.

### **Short Move**

---

An example of this is moving from one location to another in the same building. Ensure that you have taken the following steps before moving any items:

- Be sure that all data in your hard disk is backed up onto floppy disks.
- Enter the DOS system program and invoke the PARK command. This command will lock up your hard disk to protect it from damage while the computer is being moved.
- Turn off all power switches.
- Insert the cardboard diskette(s) supplied with the system unit into the disk drive(s) and close the disk drive levers.
- Detach all cables and cords. Next, coil and tie them to protect the connectors.
- Move each item separately.

### **Long Move**

---

This kind of move involves use of a motor or a vehicle to carry your computer and its peripherals from one location to another. Before moving any items, follow the instructions stated above. Next, repack all items in their original packing cases.

### **Microprocessor**

---

The 80386SX is a high-performance microprocessor with a 16-bit external data path, up to 16 megabytes of directly addressable physical memory and up to 64 terabytes of virtual memory space. The operating speed of the 80386SX chip is 10MHz in Normal mode and 20MHz in Turbo mode.

The 80386SX operates in two modes: protected virtual address mode and real address mode.

### **Protected Virtual Address Mode**

---

In protected mode, software can perform a task switch to enter virtual 8086 mode tasks. Each task behaves with 8086 semantics, thus allowing 8086 software (an application program or an entire operation system) to execute. The virtual 8086 tasks can be isolated and protected from one another and the host 386SX microprocessor operation system by use of paging.

Protected mode will use one of two different address spaces, depending on whether or not paging is enabled. Every selector has a logical base address of up to 32 bits in length. This 32-bit logical base address is added to the effective address to form a final 32-bit linear address. If paging is disabled, this final linear address reflects physical memory and is truncated so that only the lower 24 bits of this address are used to address the 16 megabyte memory address space. If paging is enabled this final linear address reflects a 32-bit address. This is translated through the paging unit to form a 16-megabyte physical address.

## Real Address Mode

In real mode the 386SX microprocessor operates as a very fast 8086, but with a 32-bit extension if desired. Real mode is required primarily to set up the processor for protected mode operation.

The segmentation unit shifts the selector left four bits and adds the result to the effective address to form the linear address. This linear address is limited to 1 megabyte. In addition, real mode has no paging capability.

## System Timers

The system has three programmable timer/counters controlled by the Intel 8254-2 chip. These are channels 0 through 2 defined as follows:

Channel 0	System Timer
GATE 0	TIED ON
CLK IN 0	1.190MHz OSC
CLK OUT 0	8259A IRQ 0

**Table 6 -1: Channel 0**

Channel 1	Refresh Request Generator
GATE 1	TIED ON
CLK IN 1	1.190MHz OSC
CLK OUT 1	Request Refresh Cycle

**Table 6-2: Channel 1**

NOTE: Channel 1 is programmed to generate a 15 microsecond signal.

Channel 2	Tone Generation for Speaker
GATE 2	Controlled by bit 0 of port hex 61 PP1 bit
CLK IN 2	1.190MHz OSC
CLK OUT 2	Used to drive speaker

**Table 6-3: Channel 2**

The 8254-2 timer/counter is treated by system programs as an arrangement of four programmable external I/O ports. Three are treated as counters; the fourth is a control register for mode programming.

### **System interrupts**

Sixteen levels of system interrupts are provided by the 80386SX NMI and two 8259A interrupt controller chips. The following shows the interrupt-level assignments' decreasing priority:

Level	Function
Microprocessor NMI	Parity or I/O Channel Check
Interrupt Controllers	
CTLR1      CTLR2	
IRQ 0	Timer Output 0
IRQ 1	Keyboard (Output Buffer Full)
IRQ 2 ←	Interrupt from CTLR 2
IRQ 8	Realtime Clock Interrupt
IRQ 9	Software Redirected to INT OAH (IRQ2)
IRQ 10	Reserved
IRQ 11	Reserved
IRQ 12	Reserved
IRQ 13	Coprocessor
IRQ 14	Fixed Disk Controller
IRQ 15	Reserved
IRQ 3	Serial Port 2
IRQ 4	Serial Port 1
IRQ 5	Parallel Port 2
IRQ 6	Diskette Controller
IRQ 7	Parallel Port 1

**Table 6-4: Interrupt Level Assignment**

---

## **ROM Subsystem**

---

The ROM subsystem has a 32K by 16-bit arrangement consisting of two 32K by 8-bit ROM/EPROM modules. The odd and even address codes reside in separate modules. The top of the first megabyte and the bottom of the last megabyte address space is assigned to ROM (hex OF0000 and hex FF0000). Parity checking is not done on ROM.

BIOS has been provided in this subsystem.

---

## **RAM Subsystem**

---

The RAM subsystem starts at address hex 000000 of the 16M address space. It consists of either 640KB or 1MB in the form of 256K or 64K by 1-bit RAM modules. Memory refresh forces one memory cycle every 15 microseconds through channel 1 of the timer/counter. The following functions are performed by the RAM initialization program:

- Write operation to any memory location.
- Initialization of channel 1 of the timer/counter to the rate generation mode (15 microseconds).

Note:

Memory can be used only after being accessed or refreshed eight times,

## Direct Memory Access

Eight DMA channels are **supported** by the system. Two Intel 8237-5 DMA controller chips (four channels in each chip) are used to provide eight DMA channels. The DMA channels are assigned as follows:

CTR 1		CTR 2	
CH 0	Spare	CH 4	Cascade for CTRL 1
CH 1	SDLC	CH 5	Spare
CH 2	Diskette	CH 6	Spare
CH 3	Spare	CH 7	Spare

**Table 6-5: DMA Channels**

### DMA Channel

Channels 0 through 3 are contained in DMA controller 1. Transfers of 8-bit data, 8-bit I/O adapters and 8-bit or 16-bit system memory are supported by these channels. Each of these channels will transfer in 64KB blocks throughout the 16-megabyte system address space.

Channels 4 through 7 are contained in DMA controller 2. To cascade channels 0 through 3 to the microprocessor, use channel 4. Transfers of 16-bit data between 16-bit adapters and 16-bit system memory are supported by channels 5, 6 and 7. DMA channels 5 through 7 will transfer data in 128KB blocks throughout the 16-megabyte system address space. These channels will not transfer data on odd-byte boundaries.

The addresses for the page register are as follows:

Page Register	I/O Hex Address
DMA Channel 0	0087
DMA Channel 1	0083
DMA Channel 2	0081
DMA Channel 3	0082
DMA Channel 5	0088
DMA Channel 6	0089
DMA Channel 7	008A
Refresh	008F

**Table 6-6: I/O Hex Address**

Address generation for the DMA channels is as follows:

For DMA Channels 3 through 0		
Source	DMA Page Registers	8237A - 5
Address	A23 $\longleftrightarrow$ A16	A15 $\longleftrightarrow$ A0

**Table 6-7: DMA Channel 3 Through 0**

Note: To generate the addressing signal “byte high enable” (BHE), invert address line A0.

For DMA Channels 7 through 5		
Source	DMA Page Registers	8237A - 5
Address	A23 $\longleftrightarrow$ A17	A16 $\longleftrightarrow$ A1

**Table 6-8: DMA Channels 7 Through 5**

Note: The BHE and A0 addressing signals are forced to a logical 0. DMA channel addresses do not increase or decrease through page boundaries 64KB for channels 0 through 3 and 128KB for channels 5 through 7.

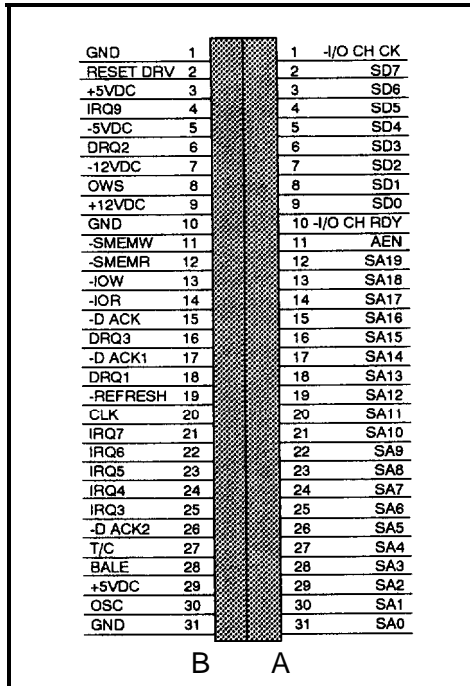


## I/O Channel Slots

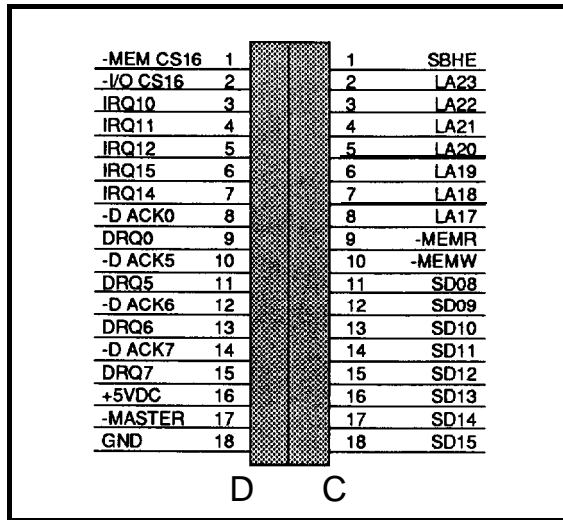
The I/O channel supports:

- Refresh of system memory from channel or microprocessors
- Selection of data accesses (either 8- or 16-bit)
- Interrupts
  - 24-bit memory addresses (16MB)
  - I/O wait-state generation
- I/O address space hex 100 to hex 3FF
- Open-bus structure (allowing multiple micro-processors to share the system's resources, including memory)
- DMA channels

The pinouts of the expansion bus I/O channels are shown as below and on the next page.



**Figure 6-10: 62-Pin Expansion Bus I/O Channels**



**Figure 6-11: 36-Pin Expansion Bus I/O Channels**

### Math Coprocessor Control

The math coprocessor functions as an I/O device through I/O port addresses hex 0F8, 0FA and 0FC. The microprocessor sends OP codes and operands to I/O ports. The microprocessor also receives and stores results through the same I/O ports. The “busy” signal sent by the processor forces the microprocessor to wait until the coprocessor is finished executing.

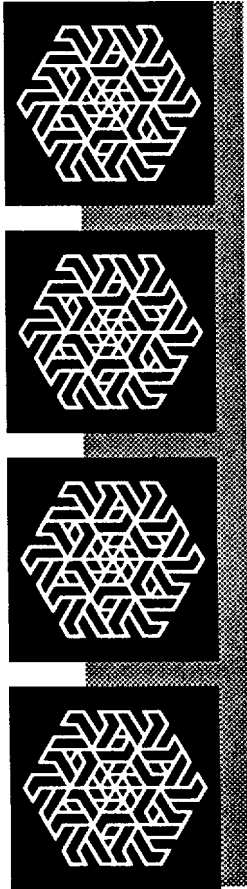
The following describes the math coprocessor controls:

#### **0F0**

The latched math coprocessor busy signal can be cleared with an 8-bit “out” command to port F0. The coprocessor will latch “busy” if it asserts its error signal. Data output should be zero.

#### **0F1**

The math coprocessor will reset if an 8-bit “out” command is sent to port F1. Again, the data output should be zero.



# ***Chapter 7***

## ***Glossary***

Some of the terms you will come across frequently in this manual are defined here.

***add-on card***

- This card connects through expansion slots to the motherboard. Also known as an adapter, an expansion card or an interface card, this is used to increase the capabilities of your computer.

***address***

- This is a value that is given to specific memory locations so that data can be read or written, Make sure that devices do not have the same address. Otherwise, there will be an address conflict,

***ASCII***

- This is an acronym for the American Standard Code for Information Interchange. The ASCII code includes both control and graphic characters, and is used for exchanging information between data-processing systems, data-communication systems and related equipment.

***asynchronous communication***

- A type of information vehicle whereby data can be transmitted at any time without requiring synchronized timing.

***back up (v)***

- To make a spare copy of a disk or of a file.

***backup (n)***

- A copy of a disk or file.

***bank***

- The area on a printed circuit board for RAM chips is usually divided into rows. These are called banks.

**BIOS**

- This stands for Basic Input Output System, BIOS controls the real-time clock and disk drives as well as the computer's peripheral equipment.

**bit**

- This is a binary data digit, either 1 or 0. 1 or 0 represents a single unit of data.

**boot**

- This means to turn on the power switch and load the operating system (DOS) into the computer so that it is ready to accept software applications.

**bus**

- This is a set of lines that transmit signals/information between the components within the computer. If the I/O channel is 32-bit, this means the data travels at least twice as fast as data on a 16-bit data bus.

**byte**

- A group of data units forming a single unit of data. There are eight bits in a single byte.

**clock (processing) speed**

- This measurement, usually given in MHz (megahertz) tells how fast the microprocessor in your computer handles data. The higher the number, the faster your computer.

**CPU**

- Central Processing Unit. Also known as a microprocessor. This chip processes all the instructions in the computer.

**computer**

- An electronic device that can receive, store and transmit data, and process arithmetic or logic operations.

**cursor**

- The blinking, moving spot of light that marks the active place on the monitor.

***data***

- Any kind of information. However, this word is generally used to describe computer-related information.

***debug***

- A method for correcting computer errors.

***default***

- This is an existing setting in a computer.

***DIP***

- This is an acronym for Dual In-line Package, which is a method for packaging integrated circuits.

***directory***

- A directory works like a desk drawer to keep files. It contains not only your files but also the information on the size of the file and the dates they were created and updated. It is always good to organize all the related files in the same directory.

***diskette***

- This refers to removable data storage disks, sometimes also called floppies or floppy disks. Diskettes generally come in two sizes: 5.25" and 3.5".

***disk drive***

- A device that stores and retrieves data.

***display***

- The information/graphics visible on the monitor screen.

***DOS***

- Disk Operating System. This is a set of commands is used to control the operations of a computer and its peripheral components.

***DRAM***

- Dynamic Random Access Memory. This type of RAM chip differs from Static Random Access Memory (SRAM).

**driver**

- A program that lets a peripheral device and a computer function harmoniously; a hard disk driver controls exchanges between a hard disk and a computer.

**expansion slot**

- This is a slots in which adapters and/or cards can be housed.

**file**

- A file is a collection of related information/data you store on a diskette or a hard disk drive.

**filename**

- Each file on a disk has a name. This name has two parts: a filename and an extension. In DOS, filenames are from one to eight characters long. An extension starts with a period, has three characters and follows immediately after the filename.

**fixed or hard disk**

- This is a non-removable disk used for storage of large volumes of data.

**format**

- The arrangement of data on a magnetic disk. Format also means to prepare a disk.

**hardware**

- All physical components of a computer.

**Hz**

- Hertz. This signifies one complete cycle of a wave signal.

**I/O**

- Input/Output. The transfer of data between the computer and its peripheral components.

**IC**

- Integrated Circuit.

***interface***

- A means for electronic machines to communicate. Interface also means to communicate with a computer and its peripheral components.

***kilobyte (KB)***

- A single data unit that is composed of 1024 bytes.

***math coprocessor***

- A math coprocessor lets you do arithmetic and calculations more efficient.

***megabyte (MB)***

- A single data unit that is composed of 1,048,576 bytes.

***memory address***

- A hexadecimal or decimal value given to a memory location.

***microprocessor***

- This is an integrated circuit that receives coded instructions for execution. It is also referred to as a CPU.

***modem***

- A modem lets your computer communicate with other computers over telephone lines.

***motherboard***

- It is the main printed circuit board in the system case. It is also known as a mainboard or systemboard.

***MS-DOS***

- The Microsoft Disk Operating System. This is the most popular operating system for IBM PCs and compatibles.

***network***

- A network lets everyone in your group communicate with one another or share the cost of high-performance resources.



***ns***

- Nanoseconds. This is a unit of time measurement for processing speed.

***operating system***

- This is software that controls the execution of programs.

***output***

- Any information or bits of data that are channeled from one electronic device to another.

***partition***

- A disk drive can be divided into several logical sections or partitions, each of which becomes a logical device with a drive letter.

***peripheral***

- Output devices which are driven by the computer.

***port***

- A communication channel between a computer and its peripheral components.

***printed circuit board***

- An electronic circuit board sandwiched between fiberglass plates.

***program***

- A series of instructions that command the computer to perform certain tasks.

***prompt***

- A screen message or position of the cursor at the beginning of a line.

***RAM***

- Random Access Memory; read/write memory. The memory in a computer while it is activated. When the power is turned off, this type of memory is cleared.

**ROM**

- Read Only Memory. This is data that is stored on an IC in the computer.

**RS-232**

- RS232 is a standardized communications interface between data communication equipment and your computer.

**setup**

- This section guides you through the preparations you'll need to make before operating your computer. If this is your first computer, you're advised to read this section carefully. Although this system has been designed to be as foolproof as an ordinary television set, a careful reading of this section will help you to ensure the long life and troublefree operation of your computer.

**software**

- Computer programs such as a word processor, operating system or programming languages.

**synchronous transmission**

- Syncopated transmission of signals between devices.

**Turbo**

- High-speed.

**virtual disk**

- Also referred to as a RAM disk, this is a portion of memory used to simulate a hard disk.

**wait state**

- Wait states are pauses. Zero wait state means there are no pauses when the contents of the memory chips are being read.

**window**

- An independent screen that can be invoked onto the monitor and in which data can be viewed, altered or stored.