

Finding Your Way Around the System

You've bought your Portégé 610CT computer, taken everything out of the box. Now you may be asking yourself, "OK, now what do I do?" Well, this chapter is for you. This chapter helps you set up your computer, gives you tips on working comfortably and takes you on a tour of the computer's features.

Make Sure You Have Everything

Your Portégé 610CT computer comes with everything you need to get up and running quickly. However, before you rush off, it's a good idea to make sure you received everything you were supposed to. This information is listed on the Quick Start Card at the top of the box.

If any items are missing or damaged, notify your dealer immediately. For additional help, contact Toshiba as described in "If You Need Further Assistance" on page 234.

Select a Place to Work

Your Portégé 610CT is a portable computer, designed to be used in a variety of circumstances and locations. However, by giving some thought to your work environment, you can protect the computer and make your work hours more comfortable.

Keep the Computer Comfortable

Use a flat surface with enough room to operate comfortably. If you're planning to use a printer or other external device, make sure there's enough space for it as well.

To keep your computer in prime operating condition, make sure your work area is free from:

- ❖ dust, moisture and direct sunlight.
- ❖ liquids and corrosive chemicals.



Don't spill liquids into the computer. If you spill a liquid into the keyboard, turn the computer off, unplug it from the AC power source, and let it dry completely before turning it on again.

If the computer does not operate correctly after you turn it back on, contact a Toshiba authorized service provider.

- ❖ objects that generate a strong electromagnetic field, such as stereo speakers or speakerphones.
- ❖ rapid changes in temperature or humidity and sources of temperature changes such as air conditioner vents or heaters.
- ❖ extreme heat, cold or humidity. Operate the computer within a temperature range of 40 to 95 degrees Fahrenheit (5 to 35 degrees Celsius) and a relative humidity of 20 to 80 percent.

Keep Yourself Comfortable

Strain and stress injuries are becoming more common as people spend more time using their computers. However, with a little care and proper use of the equipment, you can work comfortably throughout the day.



Using the computer keyboard incorrectly can result in discomfort and possible injury. If your hands, wrists, and/or arms bother you while typing, discontinue using the computer and rest. If discomfort persists, consult a physician.

In addition to the hints provided in the following sections, there are a number of books available on ergonomics, repetitive strain injury, and repetitive stress syndrome.

Placement of the Computer

Proper placement of the computer and external devices is important to avoid stress-related injuries:

- ❖ Place the computer on a flat surface at a comfortable height and distance. Your arms and hands should be in a relaxed position with your forearms parallel to the floor. The display should be no higher than eye level.
- ❖ Maintain good posture with your body relaxed and your weight distributed evenly. You should be able to type without twisting your torso or neck, and see the display panel without slouching.
- ❖ Adjust the display panel to avoid glare.
- ❖ If you use a paper holder, set it at about the same height and distance as the computer.

Seating and Posture

Proper seating is one of the primary factors in reducing work strain. Some people find an ergonomic (backless) chair more comfortable than a conventional chair. Whichever type you choose, refer to the following guidelines to adjust your chair for maximum computing comfort.

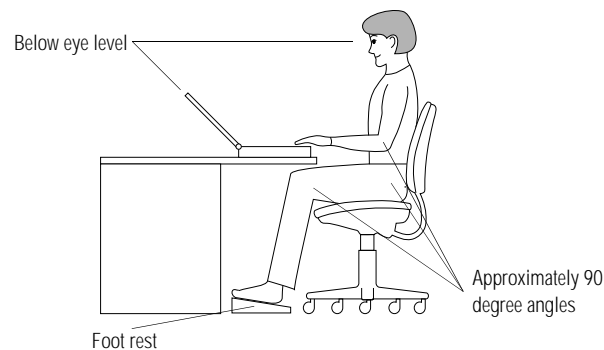

Correct posture and positioning of the computer

- ❖ Position your chair so the keyboard is at or slightly below the level of your elbow. You should be able to type comfortably with your shoulders relaxed.

If you are using a conventional chair:

- ❖ Your knees should be slightly higher than your hips. If necessary, use a foot rest to raise the level of your knees and ease the pressure on the back of your thighs.
- ❖ Adjust the back of your chair so it supports the lower curve of your spine. If necessary, use a cushion to provide extra back support. Lower back support cushions are available at many office supply stores.
- ❖ Sit with your back straight so that your knees, hips and elbows form approximately 90 degree angles when you work. Do not slump forward or lean back too far.

Lighting

Proper lighting can improve the legibility of the display and reduce eye strain.

- ❖ Position the display panel so that sunlight or bright indoor lighting does not reflect off the screen. Use tinted windows or shades to reduce glare.
- ❖ Avoid placing your computer in front of a bright light that could shine directly in your eyes.
- ❖ If possible, use soft, indirect lighting in your computer work area.

Arms and Wrists

- ❖ Avoid bending, arching, or angling your wrists. Keep them in a relaxed, neutral position while typing.
- ❖ Exercise your hands, wrists and arms to improve circulation.

Work Habits

The key to avoiding discomfort or injury from repetitive strain is to vary your activities. If possible, schedule a variety of tasks into your work day. Finding ways to break up the routine can reduce stress and improve your efficiency.

- ❖ Take frequent breaks to change position, stretch your muscles, and relieve your eyes.
- ❖ Avoid performing repetitive activities for prolonged periods of time. Vary activities from one task to another.
- ❖ Focusing your eyes on your computer screen for long periods of time can cause eye strain. Look away from the computer frequently and focus your eyes on a distant object.

Find Out Where Everything's Located

If you've never used a notebook computer before, you're probably wondering how an entire computer can fit into so small a case.

The next few pages take you on a guided tour of the computer and its components.

Rather than reading through this section, you may prefer to use it as a reference as you move through the remainder of the manual and need to locate specific parts of the computer. This information is also available in the electronic form of this manual, described in “Using Online Documentation” on page 191.

Don't worry if you don't know what some parts of the computer do. Some items in this tour support more advanced computing functions that you may want to use as your computing needs and skills increase.

The Front with the Display Closed

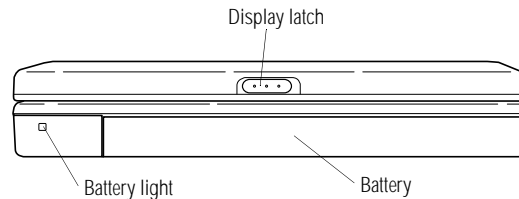

The front with the display closed



The **battery light** tells you about the current battery charge. For more information, see “Monitoring Battery Power” on page 82.

Sliding the **display latch** to the right lets you open the computer's display panel. For more information, see “Open the Display” on page 25.

The **battery** powers the computer when the AC adapter is not attached. To remove and replace the battery, see “Replacing Batteries” on page 93.

The Left Side

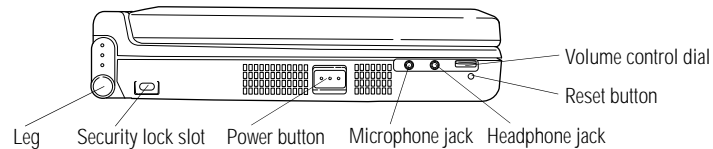



The left side

The **leg** lets you adjust the angle of the computer. You use it with the leg on the right side.

 Attaching a special cable to the **security lock slot** lets you anchor your computer to your desk or other large, heavy object. For more information, see “Applying Physical Restraints” on page 153.

 Pressing the **power button** turns the computer on and off. For more information, see “Turn the Computer On” on page 26.

 The 3.5 mm monaural **microphone jack** lets you connect an external monaural microphone or other audio input device. Connecting a microphone or other device to this jack disables the internal microphone automatically.

 The 3.5 mm **headphone jack** lets you connect stereo headphones or other audio output devices, such as external speakers. Connecting headphones or another device to this jack disables the internal speaker automatically.

 Pressing the **reset button** restarts the computer. Use this button only if all other attempts at restarting the computer have failed.

 The **volume control dial** lets you adjust the loudness of the system speaker.

The Back

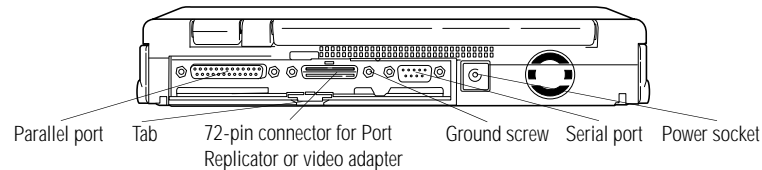

The back

To uncover the ports, open the port cover by pulling down on its center **tab**, and slide the cover into the slot at the lower edge of the computer.



Use the **parallel port** to connect a printer or other parallel device. For more information, see “Connecting a Parallel Printer” on page 23.



Use the **72-pin connector for Port Replicator or video adapter** to connect an adapter for an external monitor or the Port Replicator (optional). The Port Replicator provides all the ports of the Portégé 610CT computer and additional PS/2 mouse and keyboard ports. For more information, see “Using the Port Replicator” on page 139.



The **ground screw** provides a grounding point for the computer.



Use the **serial port** to connect a serial mouse, printer or other serial device. For more information, see “Connecting an External Modem” on page 119.



The **power socket** is where you plug in the AC adapter. For more information, see “Connect to a Power Source” on page 15.

The Right Side

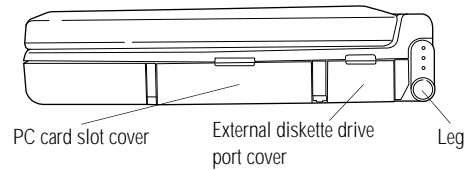

The right side



The **PC card slot cover** protects the PC card slot. This slot lets you install up to two Type I or Type II PC cards or one Type III PC card. For more information, see “Little Cards that Do Big Things” on page 105.



The **external diskette drive port cover** protects the port to which you connect the external diskette drive. The diskette drive is compatible with 1.44MB and 720KB 3 1/2" diskettes. For more information on the external diskette drive, see “Connect the External Diskette Drive” on page 20.

The **leg** lets you adjust the angle of the computer. You use it with the leg on the left side.

The Underside

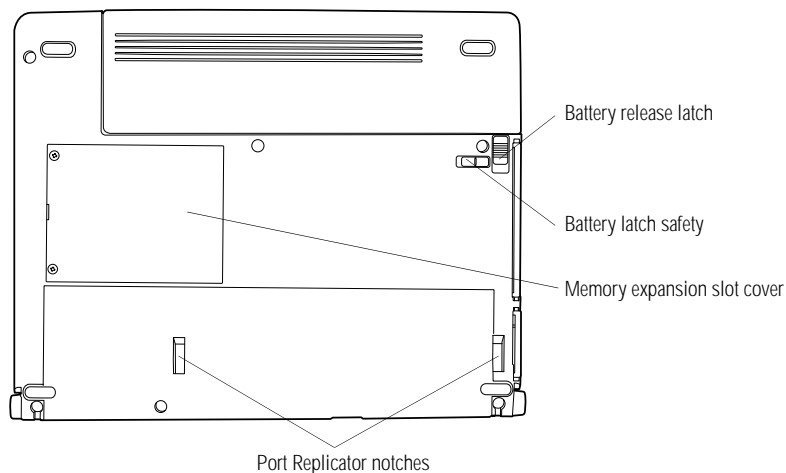

The underside



The spring-loaded **battery release latch** releases the battery.



The **battery latch safety** prevents accidental release of the battery.



The **memory expansion slot cover** protects a slot for adding extra memory to your computer. For more information, see “Adding Memory (Optional)” on page 16.

The **port replicator notches** help align an optional port replicator. For more information, see “Using the Port Replicator” on page 139.

The Front with the Display Open

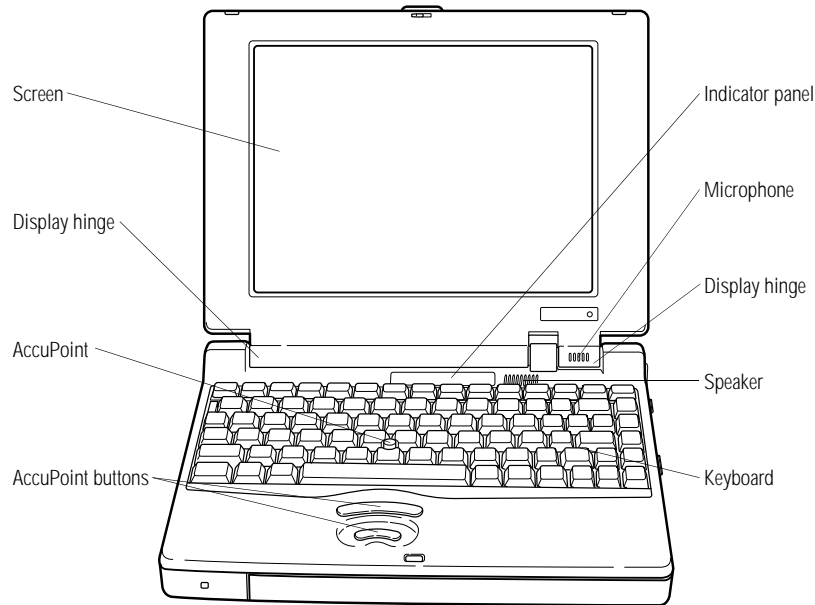

The front with the display open

To open the display, slide the display latch on the front panel to the right as you lift the display. Position the display at a comfortable viewing angle.

The computer's **screen** is a liquid crystal display (LCD) that provides clear, sharp color images.

The **display hinges** attach the display panel to the computer.

The **AccuPoint** pointing device combines the function of a mouse with the convenience of never having to remove your hands from the keyboard. For more information, see “Using the AccuPoint Pointing Device” on page 28.

Use the **AccuPoint buttons** with the AccuPoint to access commands in your programs. The larger (primary) button acts as the left button on a mouse. The smaller (secondary) button acts as the right mouse button. For more information, see “Using the AccuPoint Pointing Device” on page 28.

The lights on the **indicator panel** provide information about various system functions. The next section discusses the indicator panel lights.

The built-in **microphone** lets you record sounds.

The **speaker** lets you hear system alarms and sounds associated with your software. For more information, see “Different Ways to Turn the Computer On” on page 181.

The 82-key **keyboard** provides all the functionality of a full-sized 101-key keyboard. For more information, see “How to Save Your Work” on page 58.

The Indicator Panel

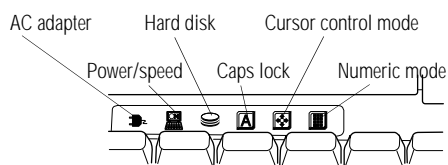

The indicator panel



The **AC adapter** light glows green when the AC adapter is providing power to the computer. If the adapter's output voltage is abnormal or if the power supply malfunctions, this indicator flashes orange.



The **power/speed** light indicates whether the computer is on or off and shows the speed at which the computer is processing information. The light glows green to indicate high speed and orange to indicate low speed.



The **disk** light indicates whether the hard disk or diskette drive is currently in use. Do not turn the computer off if this light is on.



The **caps lock** light comes on when you press the Caps Lock key. When this light is on, pressing a letter key on the keyboard produces an uppercase (capital) letter. For more information, see “The Character Keys” on page 54.



When the **cursor control mode** light is on, pressing a key on the overlay moves the cursor as shown by the white indicator printed on the left front of the key instead of the letter printed on the top of the key. For more information, see “The Cursor Control Overlay” on page 176.



When the **numeric mode** light is on, pressing a key on the overlay produces the white number printed on the right front of the key instead of the letter printed on the top of the key. For more information, see “Typing Numbers” on page 55.

Let's Start at the Very Beginning...

Now that you know where everything is, it's time to get to work. If you're new to computers or have never used a notebook computer before, this chapter provides easy-to-follow steps for getting the computer up and running.

Connect to a Power Source

Your computer requires power to operate. By connecting the computer to a power source you can provide power to run the computer and charge the battery. To provide power to your computer, use the AC adapter and power cord to connect the computer to a live power outlet.

Before you can use the battery to run the computer you must charge it. Leave the computer plugged in for at least three hours with the computer turned off. When you get up, the battery will be completely charged and ready to power the computer.

To connect your computer to a power source, follow these steps:

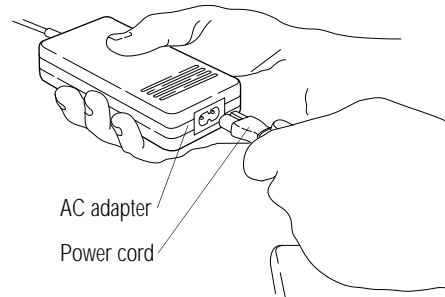

Connecting the power cord to the AC adapter

- 1 Connect the socket end of the power cord to the AC adapter.**

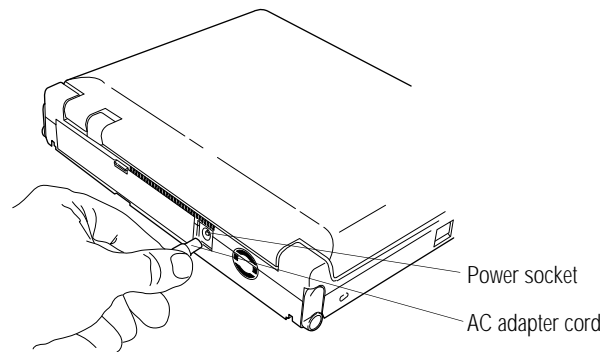

Connecting the AC adapter cord to the computer

- 2 Connect the DC OUT end of the AC adapter cord to the power socket on the back of the computer.**
- 3 Insert the plug end of the power cord into a live wall outlet.**

The AC adapter light on the indicator panel glows green.

Adding Memory (Optional)

Your computer comes with enough memory to run most of today's popular applications. However, you may want to increase the computer's memory.

With additional memory, the computer:

- ❖ can run more programs and open more documents at the same time.
- ❖ runs Windows and Windows applications much faster.

By installing extra memory now, you'll be able to operate your computer at its maximum capacity from the start. Of course, you can always come back to this section if you decide to add memory at a later time.

Sizes of Memory Modules

Additional memory is easy to install. Memory modules, available from your dealer, come in the following sizes:

<i>Memory Module</i>	<i>Total Memory</i>
8MB	16MB
16MB	24MB
32MB	40MB

Install the Memory Module

The memory module installs into the memory expansion slot on the bottom of the computer as follows:

- 1 Turn the computer off.**



Installing a memory card with the computer's power on may damage the computer, the card or both.

- 2 Close the display and remove any cables you may have connected. (If you're following the steps in this chapter, you haven't connected any yet.)**
- 3 Turn the computer upside down.**

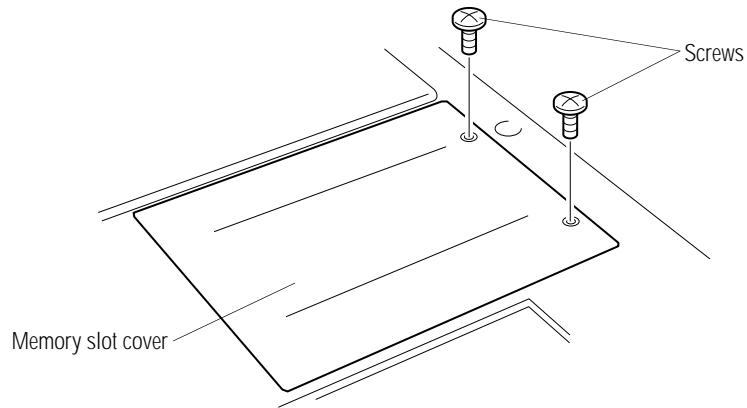

Removing the memory slot cover

- 4 Use a small Phillips screwdriver to remove the two screws that secure the memory slot cover.**
- 5 Remove the memory slot cover.**

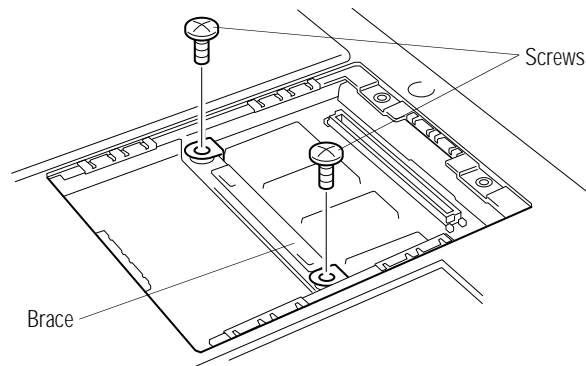

Removing the screws from the brace

- 6 Remove the two screws from the brace at the center of the memory expansion slot.**

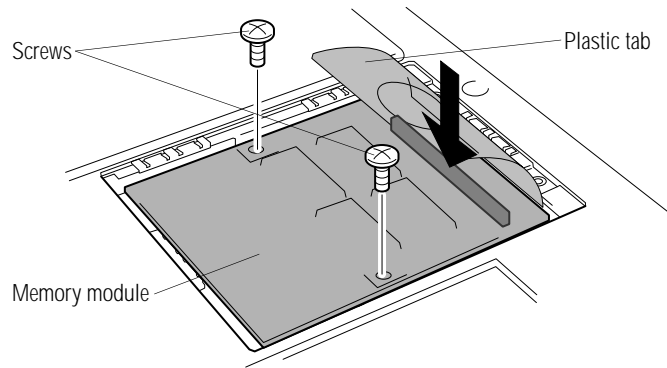

Inserting a sample 8MB memory module

- 7 Carefully place the module in the slot with the connector facing down and aligned with the corresponding connector on the computer.**



Do not touch the connectors on the memory module or on the computer. Debris on the connectors may cause memory access problems.

- 8 Make sure the holes in the memory module are aligned with the holes in the brace.**
- 9 Gently press down on the memory module.**

When the module is fully seated, it clicks into place. Do not force the module into position. The memory module should be level.
- 10 Secure the module to the brace, using the two screws you removed in step 6.**
- 11 Fold down the plastic tab and replace the memory slot cover.**

12 Replace the screws and tighten them.

13 Turn the computer over.

When you turn your computer on, it will recognize the additional memory automatically.

Connect the External Diskette Drive

The Portégé 610CT's external 3 1/2" diskette drive is useful for installing software on the hard disk, exchanging information with other systems, and making backup copies of the files on your system.

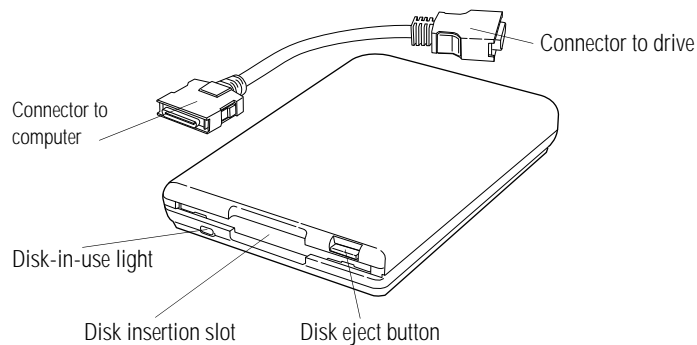

The external diskette drive and connector cable

A protective flap inside the **disk insertion slot** automatically retracts when you insert a diskette. Push the **disk eject button** to remove a diskette from the drive.

The **disk-in-use light** goes on when the computer is accessing a diskette.

To attach the external diskette drive to the computer, follow these steps:

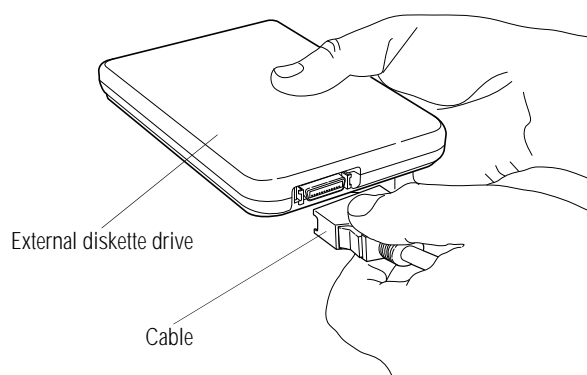

Attaching the cable to the external diskette drive

1 Connect the cable to the external diskette drive.

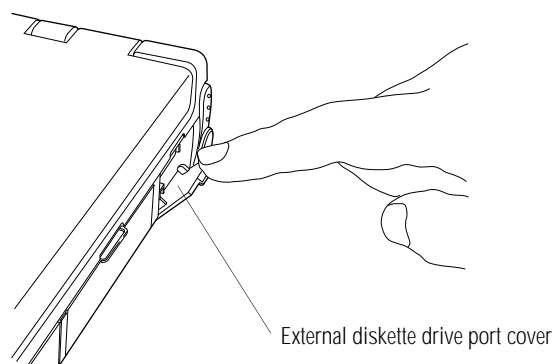

The external diskette drive port cover

2 Open the external diskette drive port cover, located on the right side of the computer.

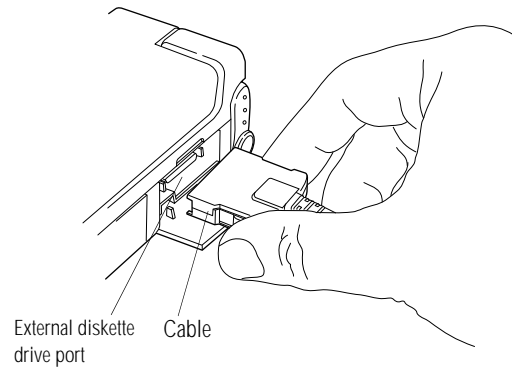

Attaching the external diskette drive

- 3 Attach the cable from the external diskette drive to the external diskette drive port.**



You may attach the external diskette drive with the computer on or off. If you attempt to use the diskette drive when it is not attached to the computer, the computer displays an error message.

The computer automatically recognizes the external diskette drive and calls it the A drive.

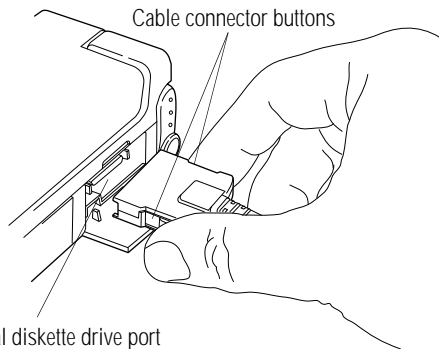

Disconnecting the external diskette drive

To detach the external diskette drive from the computer, press the **cable connector buttons** (on each side of the cable connector) and gently pull the connector out of the **external diskette drive port**.



If you try to access a diskette in the external diskette drive after disconnecting the drive, you will get a disk error message.

Connecting a Parallel Printer

If you've already purchased a printer, now is a great time to connect it to the computer. If you don't have a printer yet, don't worry. You can always connect one later.

The most common type of printer is a parallel printer. To connect a parallel printer, you'll need a standard parallel printer cable. You may have received a cable when you purchased your printer. Otherwise, printer cables are available from your dealer and at most computer and electronics stores.

To connect the printer to the computer, follow these steps:

- 1 Identify the two ends of the printer cable. One end connects to the computer. The other end connects to the printer.**

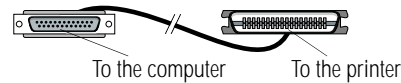

Identifying the ends of the printer cable

- 2 Connect the printer cable to your printer.**

If you're unsure how to do this, your printer's documentation will tell you how.

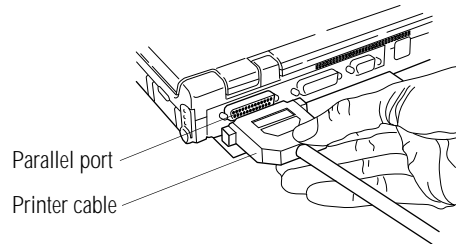

Connecting the printer cable to the parallel port

- 3 Connect the printer cable to the computer's parallel port.**



Don't connect the printer cable if the computer's power is on. Doing so may cause damage to the printer, the computer or both.

- 4 Plug the printer's power cable into a live AC outlet.**



The printer must be connected, turned on, and ready (online) before you turn the computer on.

Open the Display

The final step before you turn your computer on is to open the display.

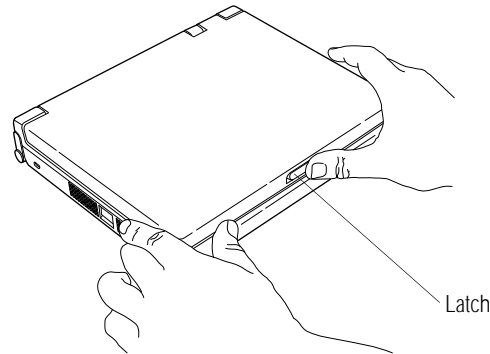

Opening the display panel

- 1 Facing the front of the computer, locate the latch on the front center of the display panel.**
- 2 Slide the latch to the right and lift the display panel.**
- 3 Adjust the display panel to a comfortable viewing angle.**



To avoid damaging the display panel, do not force the panel beyond where it moves easily.

Fill In Your Registration Card and Mail It

Take a few minutes now to fill in and mail your product registration card. The card was on the keyboard of your computer when you first opened the display panel. Sending in your product registration card lets Toshiba keep you up to date with information about new products and upgrades.

Registering your computer also extends your Toshiba warranty world-wide at no charge to you. See the registration card and warranty information for details about the warranty options available through Toshiba.

Turn the Computer On

Finally, the preparation is over. It's time to turn the computer on and get to work. To turn the computer on, follow these steps:

- 1 Make sure there's no diskette in the external diskette drive.**
- 2 If you have a printer connected to your computer, turn the printer on and wait until it's ready (on line).**
- 3 Locate the power/speed light on the indicator panel.**

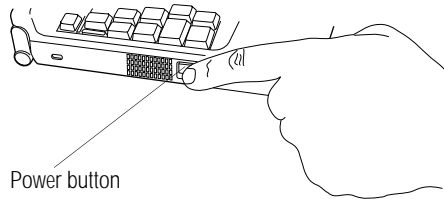

Power button

Turning the power on

- 4 Press and hold the power button on the left side of the computer. Hold the power button in until the power/speed light turns on.**

The computer loads MS-DOS, displays several messages and opens and sets up Microsoft Windows. Continue with the next section.

Set Up Windows for Your Printer

The first time your computer loads Windows, it gives you the opportunity to set up Windows to work with your printer. If you have a printer, continue with the steps in this section. If you purchase a printer later, choose Cancel now and see “Setting Up Windows to Work with Your Printer” on page 60 when you’re ready to connect it.



If you want to set up a printer later, you'll need master program diskettes before you can do so. For information about master program diskettes, see “Create or Purchase Master Diskettes” on page 29.

To set up Windows to work with your printer when you first open Windows, follow these steps:

- 1 When Windows opens the Printers dialog box during Windows Setup, scroll through the List of Printers until you find yours.**

If your printer is not listed, it probably came with its own diskette. Refer to your printer documentation for installation instructions.

- 2 Select your printer and choose Install.**
- 3 Set the port to LPT1: and choose Install.**
- 4 Continue with the Windows Setup procedure.**

Using the AccuPoint Pointing Device

The Portégé 610CT's AccuPoint pointing device enables you to move the cursor and to select items on the screen.

If you're familiar with desktop computers, you may have used a mouse or trackball for this purpose. The AccuPoint provides all the functionality of a mouse or trackball without your hands ever leaving the keyboard. If you would rather use a mouse or trackball, you can connect one to the serial port.

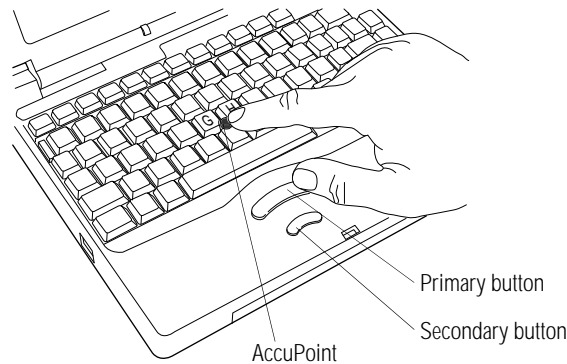

The AccuPoint pointing device

To move the pointer, gently push the **AccuPoint** in the direction you want the pointer to move. Pushing harder on the AccuPoint moves the pointer faster.

When a step instructs you to click on or choose an item, move the cursor to the item, then press and release the **primary button**. To double-click, click the primary button twice in rapid succession.

The function of the **secondary button** depends on the programs you use. It corresponds to the right button on a mouse. Check your programs' documentation to find out whether it uses the right mouse button.

Create or Purchase Master Diskettes

When you buy a program at a computer store, you receive one or more program diskettes. These program diskettes contain the files necessary to install the program on your computer's hard disk. You can also use them to reinstall your software if necessary.

However, your Portégé 610CT computer comes with a number of programs, such as Microsoft Windows, already installed on the hard disk. If any of these programs is ever damaged or deleted, you'll need program diskettes to reinstall it.

There are two ways to obtain program diskettes for your pre-installed software:

- ❖ Buy blank diskettes and run Master Disk Creator, a Toshiba program that creates program diskettes.
- ❖ Purchase the diskettes from Toshiba using the order form that came with your computer.

Preparing to Run Master Disk Creator

Disk image files on your hard disk contain all the information to create program diskettes for the factory pre-installed programs on your computer. Master Disk Creator copies these disk images to diskettes.



You cannot reinstall programs from the disk image files on the hard disk. You must use program diskettes created with Master Disk Creator to reinstall any of the pre-installed programs.

To run Master Disk Creator, you need:

- ❖ about one hour.
- ❖ up to 25 blank 3 1/2" high-density (1.44MB) diskettes. These diskettes must be write-enabled (the write-protect tab at the upper left corner of the diskette must cover the square hole).

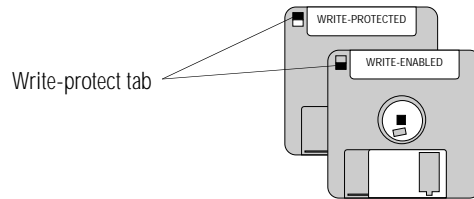

Write-protected and write-enabled diskettes

Although you can run Master Disk Creator at any time, it's a good idea to create your program diskettes the first time you start the computer. If you decide to put off the process until later, make sure you don't forget. You don't want to accidentally delete a program and have no master diskettes available from which to reinstall it quickly.

Running Master Disk Creator

Master Disk Creator is a very simple program to use. Once you start it, follow the instructions on the screen, inserting and removing diskettes as prompted. Make sure you label the diskettes as indicated by Master Disk Creator.

To run Master Disk Creator, follow these steps:

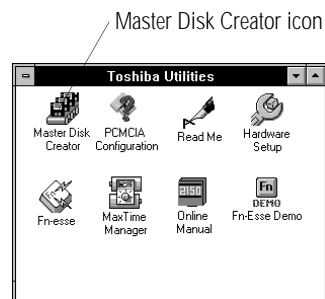

The Toshiba Utilities program group

1 Double-click the Master Disk Creator icon in the Toshiba Utilities program group.

Master Disk Creator displays a welcome screen.

- 2 **Choose OK by using the AccuPoint to move the pointer to it and clicking with the primary button.**

Master Disk creator displays a list of the available disk images:

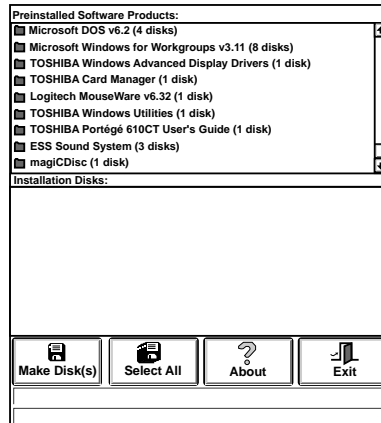

A sample list of disk images

- 3 **Select the disk images for which you want to create program diskettes. To create program diskettes of all the disk images, choose Select All.**
- 4 **Choose Make Disks.**
- 5 **Label the diskettes with the names shown on the screen.**
- 6 **If you haven't connected the external diskette drive, follow the steps in "Connect the External Diskette Drive" on page 20.**

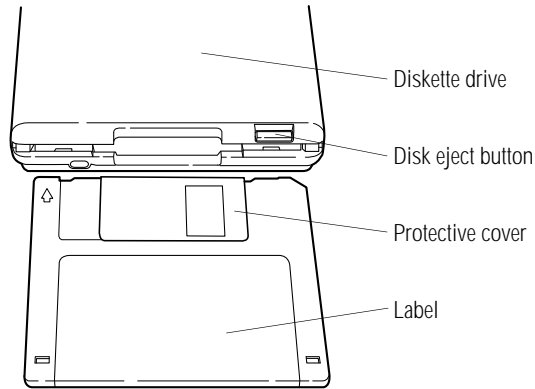

Inserting a diskette

7 Insert a blank diskette when Master Disk Creator asks for one.

The illustration above shows the correct insertion procedure. Make sure your fingers are touching the **label** and that the **protective cover** points toward the **diskette drive**. When the diskette is almost completely in the drive, you will feel a slight resistance. Push the diskette gently to secure it. When the diskette is completely in place, the **disk eject button** pops out.

8 Choose Create Disk to begin copying files to the diskette.

A meter lets you monitor the copying process.

9 When Master Disk Creator prompts you to, press the disk eject button to remove the diskette.



If the diskette drive light is on, do not remove a diskette. Doing so could destroy the information on the diskette and damage the diskette and/or the drive.

10 Write-protect the diskette by moving the tab on the back of the diskette to expose the write-protect hole.

Write-protecting a diskette prevents you from erasing or overwriting the information on the diskette.

11 Continue inserting and removing diskettes according to the instructions on the screen.

Since creating program diskettes will take some time, now is a good time to fill in your registration card if you haven't yet done so.

12 When you've finished making master diskettes, store them together in a safe place.

Getting Comfortable with Windows

Your computer automatically opens Microsoft Windows when you turn the power on. Windows uses visually recognizable elements, such as icons and menus, to perform commands and carry out computing functions.

However, if you've never seen Windows before, the screen may look rather confusing. After reading the descriptions and following the steps in this chapter, you'll get over any initial reservations and move through Windows with ease.

This chapter introduces some of the main features of Windows and lets you try out basic Windows operations on your own. Feel free to skip the lessons in this chapter. However, time spent now will help to make these operations automatic in the future.

The lessons in this chapter use the AccuPoint pointing device. For many of these tasks, you can also use the keyboard.

Exploring Program Manager

Windows opens to the Program Manager window. Program Manager is your gateway to everything that Windows has to offer. In addition, Program Manager contains most of the elements that you'll be using with any Windows program. While becoming comfortable in Program Manager, you'll develop skills that you can use with all of your programs.

The Program Manager Window

This section points out the main features of the Program Manager window. It's OK if you don't understand what these features do at this point. Within a few short pages, you'll understand almost everything here.

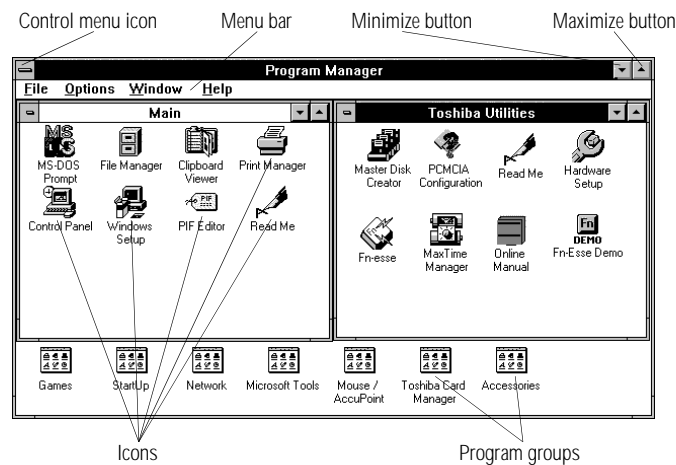

The Program Manager window

Your screen may look different from the one in the illustration, but the elements are the same.



The control menu icon gives access to the control menu. This menu lets you set such things as the size and shape of the current window.

The menu bar provides access to Windows commands and functions. Each menu contains a number of related items.



The minimize button reduces the current window, also known as the active window, to an icon at the bottom of the screen.



The maximize button enlarges the active window so that it fills the entire screen. When a window is maximized, the maximize button changes to a double-headed arrow called the restore button. When you choose the restore button, the active window returns to its previous size.

Icons represent programs that you can open from Program Manager. Icons at the bottom of the screen represent minimized program groups or windows.



A program group contains one or more icons. These icons open programs or documents that are related to each other. For example, the Toshiba Utilities program group contains programs such as Master Disk Creator, Hardware Setup and PCMCIA Configuration. These programs, unique to the Portégé 610CT, are described later in this manual.

Lesson 1: Using the AccuPoint

The AccuPoint is the basic device for moving around in Windows. If you've never used a mouse or trackball before, this lesson gives you an idea of how to move around the screen and select objects.

Follow these steps:

- 1 With the index finger of your left hand, push gently against the left side of the AccuPoint.**

Notice how the arrow (pointer) moves to the right edge of the screen.

- 2 With the index finger of your right hand, push a bit harder than you did in the previous step against the right side of the AccuPoint.**

Notice that the pointer moves faster as you increase the pressure on the AccuPoint.

- 3 Practice moving around the screen.**

Experiment with moving different directions and at different speeds. See how quickly you can point to a particular spot on the screen.

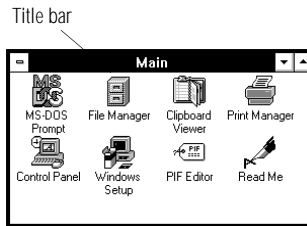

The Main program group

- 4 Move the pointer to the title bar for the Main program group.**
- 5 Using either thumb, click once on the primary button (it's the larger one).**

This highlights the title bar. Highlighting an object is also called selecting an object.

- 6 Click on several more objects.**

Notice how Windows highlights each object as you click on it.

- 7 Move the pointer outside the Program Manager border and quickly click twice on the primary button.**

Windows opens the Task List. Clicking twice is called double-clicking. The Task List is a list of all the programs you have running and is useful for switching between them. This is discussed later in this chapter.

- 8 Select the Program Manager title bar.**

Windows closes the Task List.

That's all there is to it. Now it's time to put the AccuPoint to some real use. The next lessons tell you how to use these skills in Windows.

Lesson 2: Using Menus

Menus give you access to most of the features of Windows programs, including Program Manager. This section teaches you how to choose an item from a menu.

Follow these steps:

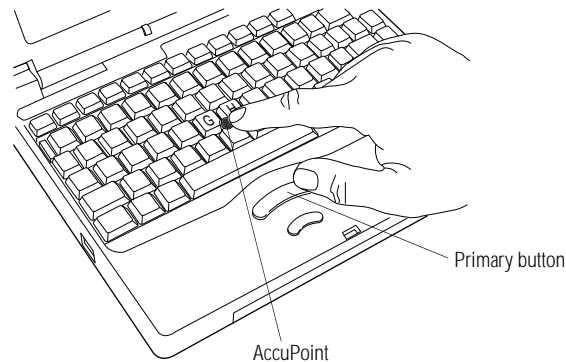

Clicking the primary button

- 1 Use the AccuPoint to move the pointer to the Window menu and click the primary button. This is also called “selecting the Window menu.”**

Program Manager	
Window	Help
Cascade	Shift+F5
Tile	Shift+F4
Arrange Icons	
1 Startup	
2 Games	
3 Microsoft Tools	
4 Mouse/AccuPoint	
5 Toshiba Card Manager	
6 Accessories	
7 Network	
8 Main	
9 Toshiba Utilities	
More Windows...	

A sample Window menu

Program Manager opens the Window menu. This menu, like all the others, contains a number of items.

2 Click on Accessories.

Accessories is now the selected program group. This is indicated by the highlighted border and title bar of the Accessories program group.



NOTE

Throughout the remainder of this manual, the two steps you just performed will be combined as "choose Accessories from the Window menu."

This is a simple example of how to use a menu. However, this is a skill you'll use probably more than any other while in Windows and Windows programs.

Lesson 3: Starting a Program from an Icon

All of the icons within the Program Manager program groups let you open a program or document. This section teaches you how to open a program from an icon, using the Control Panel program as the example.

Follow these steps:



Control

- 1 Use the AccuPoint to move the pointer to the Control Panel icon in the Main program group.**
- 2 Double-click on the primary button.**

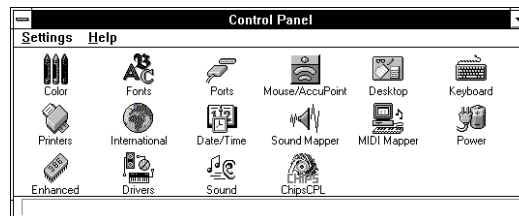

The Control Panel

Windows opens the Control Panel.

The next lesson uses the Control Panel to demonstrate additional Windows skills.

Lesson 4: Working Inside a Dialog Box

Windows programs use dialog boxes to let you choose between options. A simple example is a dialog box that asks you to confirm an action you've taken by choosing between yes and no. Although dialog boxes can vary enormously in appearance, there are basic elements common to all dialog boxes.

This section introduces some of these basic elements, using the International dialog box. In it, you'll change the way Windows displays the date. If you like the date the way it is, don't worry. You'll change everything back to normal before you're finished.

Follow these steps:



Control

1 If you haven't opened the Control Panel, choose the Control Panel icon in the Main program group.



International

2 Double-click the International icon.

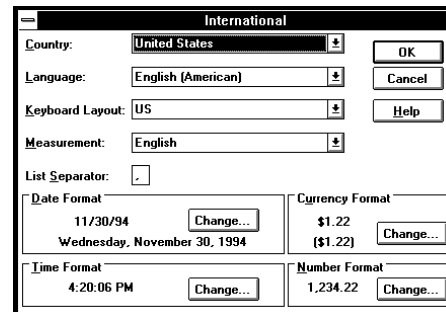

The International dialog box

Control Panel opens the International dialog box. This box controls a variety of functions that may differ based on the customs and conventions of your language and symbols.

- 3 Click once on the Change button in the Date Format section of this dialog box.**

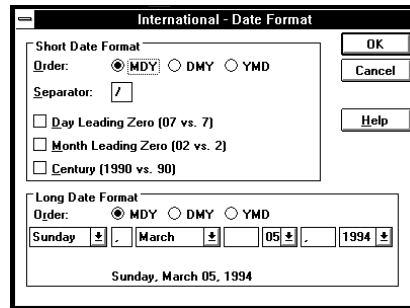

The International - Date Format dialog box

Control Panel opens the International - Date Format dialog box.

- 4 Change the order of the short date format by clicking on the circle to the left of DMY.**

The black dot moves from MDY to DMY.

- 5 Set Windows to show the century by clicking in the box next to Century.**

An X appears in the box, indicating that you've selected this option.

- 6 At the bottom of the dialog box, click on the arrow to the right of March.**

A box drops down, showing a list of options. This type of box is called a drop-down list box.

- 7 Click on Mar to choose the format for the month.**

The drop-down list box closes and indicates your new choice.

8 Click the Cancel button on the right of the screen.

The Date Format dialog box closes without making your changes (since we're only experimenting at this point), and returns you to the International dialog box.

9 Click Cancel to return to the Control Panel.

Lesson 5: Switching Between Programs

One of the most powerful aspects of Windows is its ability to have more than one program open at the same time. This saves the time it takes to close one program and open another every time you want to switch between them.

This lesson assumes that you're where the previous lesson left off, with the Control Panel open and Program Manager open and visible behind it. If not, open the Control Panel by double-clicking on the Control Panel icon in the Main program group.

Follow these steps:

1 Click anywhere in the Program Manager window.

Program Manager is now the active window and the Control Panel is behind Program Manager.

2 Hold Alt and press the tab key.



Throughout the rest of this manual, key combinations are indicated by connecting two or more keys with a plus sign (+). For example, pressing Alt + tab is the same as the above step.

Windows displays a small screen showing the Control Panel icon.

3 Release the Alt key.

Control Panel is once again the active window.

4 Press Ctrl + Esc.

Windows displays a Task List. This shows the programs that are currently open.

5 Click on Program Manager and click Switch To.

You're back to Program Manager.

Lesson 6: Changing the Size and Shape of a Window

Sometimes a program window is not the size or shape you want it to be. This lesson shows you how to change the size of a window, called “resizing a window,” using Program Manager.

Follow these steps:

1 Use the AccuPoint to move the pointer toward an edge of the Program Manager window until the pointer changes to a double-headed arrow.

The illustration below shows the pointer at the left edge of the window.

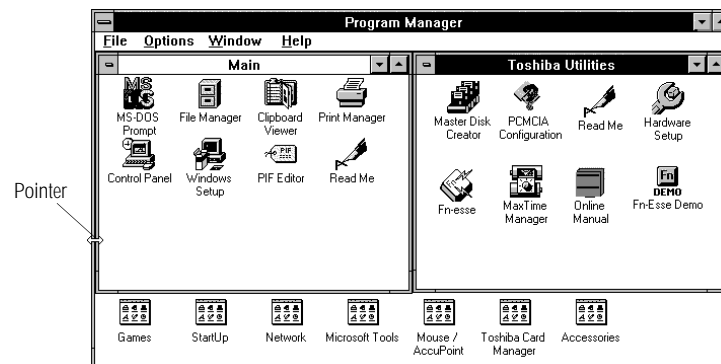

Changing the size of a window

2 Click and hold the primary button. While holding it, move the pointer towards the edge of the screen.

The Program Manager window gets larger in that direction. If your pointer is at the left edge, the window becomes wider but stays the same height.

- 3 Still holding the primary button, move the pointer in the opposite direction.**

The Program Manager window gets smaller.

- 4 Release the primary button to choose the current size.**
- 5 Click on the minimize button.**



Program Manager is reduced to an icon at the bottom of the screen.

- 6 Double-click on the Program Manager icon to restore it.**
- 7 Click on the maximize button.**

Program Manager changes from a window to taking up the entire screen. Notice that you can't resize this screen with the pointer.

- 8 Click on the restore button to restore Program Manager to the size it was after step 4.**

Lesson 7: Moving a Window

One of the advantages of using Windows is being able to have several windows open at one time. To work comfortably with more than one window open, you may need to arrange the open windows on the screen. To move a window:

- 1 Using the AccuPoint, position the pointer on the title bar of the window you want to move.**
- 2 Click and hold the primary button.**
- 3 Still holding the primary button, use the AccuPoint to drag the window where you want it.**
- 4 When you have placed the window, release the primary button.**

Lesson 8: Quickly Closing a Program

There are a number of ways to close a program. This lesson teaches you the quickest and easiest way, using the still-open Control Panel.

1 Press Alt + tab to return to the Control Panel.

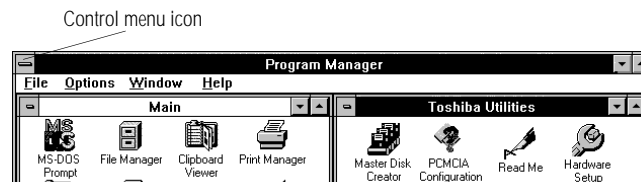

The control menu icon

2 Double-click on the control menu icon.

The Control Panel closes, returning you to Program Manager.

Lesson 9: Closing Windows

This last lesson shows you how to close Windows. Although you can use the same method as shown in Lesson 8, this section introduces a different way to close a program.

1 Press Alt + F4.

Windows displays a dialog box that asks if you really want to close Windows.

2 Choose OK.

Windows closes, returning you to a system prompt.



Windows shows a blank screen for several moments before returning you to a system prompt (for example, c:\>). Wait until you see the system prompt before proceeding—typing before you see the system prompt may produce unpredictable results.

That's all the lessons in this chapter. To return to Windows at this point, type win and press Enter.

If You're Using the Keyboard

Most of the steps in this chapter use the AccuPoint to perform Windows tasks. If you'd rather use the keyboard, this table summarizes some useful Windows keys and key combinations:

Enter	Choose the highlighted icon or button
Alt + tab	Switch to program you last used
Alt + spacebar	Open the Control menu for the current program
Esc	Close an open menu
tab	Switch between options in a dialog box
Ctrl + Esc	Open the task list

The Windows Tutorial

For more practice with Windows, try out the Windows tutorial. The tutorial covers the same material as this chapter, while providing many opportunities to practice your newly-developed Windows skills.

To run the tutorial, choose Windows Tutorial from the Program Manager Help menu.

Learning the Basics

The information in this chapter is intended for the novice computer user. Simple steps describe many day-to-day computer operations. There are also lists of helpful computing tips. By the end of the chapter, you'll have developed many of the basic skills that more advanced users take for granted.

Computing Tips

It seems that everybody's grandmother has a list of rules that will make your life better. This section presents a few rules that your grandmother would include if she were teaching you how to use your computer.

Two Things Every User Learned the Hard Way

- ❖ Save your work frequently.

Both novice and experienced computer users forget to save their work. When the power goes out and you are looking at a blank screen that contained, only moments ago, an entire afternoon's work, you'll say, "I wish I had saved!"

See the instructions in "How to Save Your Work" on page 58.

- ❖ Back up your files on a regular basis.

It's easy to put off backing up because it takes time. However, when the power goes out or you can't access your hard disk, you'll wish you had taken the time to do backups.

See the instructions in "How to Back Up Your Work on Diskettes" on page 67.

Six Things Every Portégé 610CT Computer User Should Do

- ❖ Take frequent breaks to avoid repetitive strain injuries and eye strain.

As indicated in "Keep Yourself Comfortable" on page 3, it's important to stay comfortable while you're working at your computer.

- ❖ Exit Windows before turning the computer off, unless Resume Mode is on. See "How to Start Where You Left Off" on page 52 for information about Resume Mode.

Windows goes through a complicated shutdown procedure when you return to the system prompt. If you don't let Windows shut down, it can forget things such as new icon positions.

- ❖ Set up your computer to fit your tastes and needs.

You're the one that's going to be looking at the screen while you work. If you don't like the colors on the screen, go ahead and change them. See your Windows documentation for information on changing the appearance of your screen.

- ❖ Save your work frequently.

For more about this topic, see "How to Save Your Work" on page 58.

- ❖ Scan all new files for viruses.

It's unlikely, but possible, that even new programs you buy from a computer store may contain a computer virus. See "Viruses and How to Cure Them" on page 153 for information about detecting and removing computer viruses.

- ❖ Run Master Disk Creator or purchase master program diskettes.

At some point, you may need installation diskettes for the programs that came pre-installed on your computer's hard disk. See "Create or Purchase Master Diskettes" on page 29 for more information.

Six Things You Should Never Do

- ❖ **Don't** delete COMMAND.COM.

This is the MS-DOS file that keeps it all together. If this file is lost, your computer won't know what to do when you turn it on.

- ❖ **Don't** spill a drink into the computer.

If you do spill a drink that gets into the keyboard, turn the computer off immediately. Leave it off overnight to give the keyboard time to dry out before you return to work.

- ❖ **Don't** format a disk that contains valuable information.

Formatting removes all the information that's currently on the disk. If your files are important to you, always double-check a disk before you format it.

- ❖ **Don't** turn the computer off when a drive indicator light is on.

Turning off the computer while it's reading from or writing to a disk may damage the disk, the drive or both.

- ❖ **Don't** put your diskettes or the computer near magnets, such as large stereo speakers.

Information on disks is stored magnetically. Getting a magnet too close to a disk can erase important files.

- ❖ **Don't** be afraid to use your computer, it's just a machine.

Many people are so nervous with their first computer that they forget it's merely a tool. Provided you follow the advice in this chapter, you are unlikely to do your computer any harm. So use it and have fun with it.

When You Turn the Computer On. . .

Turning your computer on seems as easy as just pressing the power button. However, what you're not seeing is everything the computer does before it finishes its startup process.

All Those Messages. . .

When you turn the computer on, it flashes a number of messages across the screen before it loads Windows. Don't worry if you don't understand any of these messages. They indicate that the computer's going through its normal startup procedure.

If you're really interested in what's going on, read "What Really Happens When You Turn the Computer On?" on page 205. This section describes the messages you see when you turn the computer on. It also tells you how to get to work immediately without waiting for all the messages to appear.

How to Start Where You Left Off

Many times, you'll turn your computer off, intending to continue a bit later. Then, when you're ready to return to work, you turn the power on and wait while the computer displays messages and loads Windows before you can load your program. Finally, you load your file and start to be productive.

There's an easier way. By turning on Toshiba's Resume Mode, you can start your computer and have everything back to where it was when you turned the power off. Resume Mode acts like an electronic bookmark. It stores the computer's current state in memory while the power is off (using the backup battery). When you turn the computer back on, Resume Mode restores the system to the state it was in before you turned the power off.

Also, since the startup procedure requires power, avoiding the startup procedure by using Resume Mode is energy efficient—it extends the amount of work you can get done before recharging your battery.

There are several ways to turn Resume Mode on and off. This section describes how to use a key combination, called a hotkey, to select Resume Mode. This is the quickest method. Turn to “Starting Again Where You Left Off” on page 91 for other methods.

To select Resume Mode, follow these steps:

- 1 Press Fn + F3 to display the power-up pop-up window.**

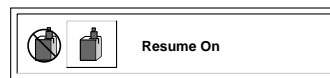

The power-up pop-up window

- 2 While continuing to hold Fn, press F3 until Resume Mode is highlighted.**
- 3 Release the Fn key.**

The system is now in Resume Mode. The next time you turn your computer off and back on, you'll be right back where you left off.



NOTE

It's always a good idea to save your files before turning the computer off (even when Resume Mode is turned on).

How to Use the Keyboard

If you've never used a computer before, you're probably asking yourself, “is this keyboard just like a typewriter? And if it is, what are all those extra keys for?” This section describes the keys on the keyboard and the differences between typing on a computer and using a typewriter.

The Character Keys

For these keys, typing on a computer keyboard is very much like typing on a typewriter. However, there are some exceptions:

- ❖ When you press the spacebar, a computer does not simply pass over an area of the page like a typewriter does. Although you may not see anything on the screen, each time you press the spacebar, the computer creates a space character just as it creates characters representing letters or symbols.
- ❖ The lowercase l (el) and the number 1 are not interchangeable.
- ❖ The uppercase O and the number 0 are not interchangeable.
- ❖ On a typewriter, the shift lock key locks all the keys into their uppercase positions. On a computer keyboard, pressing the Caps Lock key changes only the alphabet keys to uppercase—the number and symbol keys aren't affected.

The Other Keys

In addition to the character keys, the computer keyboard contains a number of keys that carry out special computer tasks. This section describes these special keys.

- ❖ The 12 function keys (F1, F2, etc.) across the top of the keyboard carry out program-specific tasks. To find out what these keys do in your program, refer to the program's documentation. Some software programs provide a template or quick reference card for these keys.
- ❖ The function of the Ctrl key (Control key) also varies according to the program you're using.
- ❖ If you're in Windows, pressing the Alt key lets you open menus.
- ❖ Pressing the Fn key simultaneously with one of the specially marked keys allows you to emulate a 101-key keyboard, turn keyboard overlays on and off (page 176) and control various system functions.

Toshiba's powerful Fn-esse Windows program allows you to assign your own Fn key combination to launch a Windows program or document quickly. Instructions for using this program are given in “Starting Programs Faster” on page 165.

Typing Numbers

The keys with white numbers on the right front are the numeric overlay. This illustration highlights the keys in the numeric overlay:

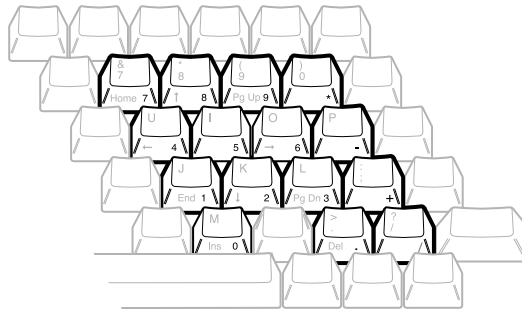

The numeric overlay

To turn the numeric overlay on and off, press Fn + F11. The numeric lock light on the indicator panel shows whether the numeric overlay is on or off.

To type lower-case letters of the overlaid keys with the overlay on, press and hold Fn while you type the letters. To type upper-case letters of the overlaid keys with the overlay on, press Fn + Shift while you type the letters.

To use the cursor control keys when the numeric overlay is on, press and hold Shift while you use the overlay keys. To return to the numeric overlay, release Shift.

How to Start a Program

Starting a program in Windows is as easy as double-clicking on the program's icon. Of course, that only works if there is an icon for the program in Program Manager. This section demonstrates two ways to start a program in Windows.

Starting an MS-DOS program from a system prompt is a little more complex. To start an MS-DOS program, refer to the program's documentation for specific instructions.

Starting a Program from an Icon

To start a program from an icon, follow these steps:

- 1 In Program Manager, make sure the Accessories program group is open. If not, double-click the Accessories icon.**

If you cannot see the Accessories program group or Accessories icon, choose Accessories from the Window menu.

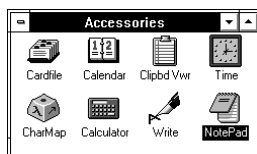

The Accessories program group

- 2 Double-click the Notepad icon.**

Windows opens Notepad. Notepad is a text editor—a scaled-down word processor without the frills.

That's really all there is to it. To close Notepad, choose Exit from the File menu.

Starting a Program from File Manager

These steps demonstrate how to start a program if there is no Program Manager icon for the program. To use this method, you need to know the filename and directory of the program you want to start.

This example, starting Notepad, uses the NOTEPAD.EXE file in the WINDOWS directory.

To start a program from File Manager, follow these steps:



1 Double-click the File Manager icon to start File Manager.

Windows opens the File Manager window.

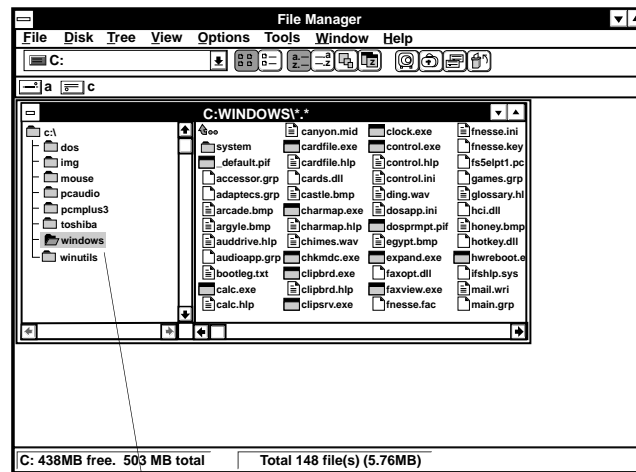

Directory tree

The File Manager window

2 In the directory tree, click on the Windows directory.

The file list shows the files in the Windows directory. If you can't see notepad.exe in the file list, click on the right half of the scroll bar to show more files.

3 Double-click notepad.exe.

File Manager opens Notepad. To close Notepad, choose Exit from the File menu.

How to Save Your Work

You've written the first chapter of the great American novel and it's time for a well deserved break. If you turn the computer off now (and Resume Mode is turned off), all your hard work will be lost. Before you go, save your work. This is one of the most important rules of computing.

When you're working in a file, all your work exists in the computer's memory. But information stored in memory is temporary: when you turn the computer off, everything in memory is lost. Therefore it's important to save your files to the hard disk or to a diskette.

Saving your files is so quick and easy, it's good to get in the habit of saving frequently. That way, if you run into trouble, such as the power going out, you won't lose the product of many long hours of work.

Your programs may also help you out. Many programs offer a feature that saves your files after a set period of time. Check your programs' documentation to see if they have an automatic save feature.

You use the same procedure to save files in all Windows programs. This section describes this procedure. If you're using an MS-DOS program, refer to your program documentation for instructions on saving files.

To save a file in a Windows program, follow these steps:

1 Choose Save from the File menu.

If you're working with a previously existing file, one that already has a filename, that's all there is to it. If you've created a new file, your program displays a Save As dialog box, like the one below.

You use this dialog box to specify where to store the file and to give it a filename.

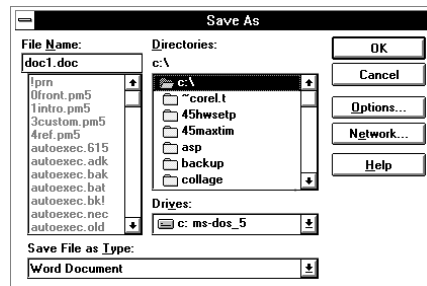

A sample Save As dialog box

- 2 Use the Drives and Directories drop-down list boxes to choose the drive and directory where you want your file to be stored.**

In the sample shown above, you set these in the Drives: and Directories: sections of the dialog box.

- 3 Type a filename and choose OK.**

A filename may consist of up to eight characters followed by a period and a three-character extension. You may use all the letters and numbers on the keyboard plus the following characters: `_`, `^`, `$`, `~`, `!`, `#`, `%`, `&`, `{`, `}`, `(`, `)`, `@`, `'` and `~`. A filename must not contain a space.

Most programs assign an extension that identifies the file as being created in that program with the data in a particular format. For example, Microsoft Word saves files with a `.DOC` extension. While you can create your own extension, this is usually unwise. Using the default for your program is a helpful reminder of where your file came from. Also, the program is unlikely to recognize a strange extension and may refuse to handle your file correctly.

How to Print Something You've Created

By this time, you've probably created a document and saved it—if not, save it now. Naturally, you want to see the results of your work by printing your file.

Before you can print your work, you need to have:

- ❖ connected the printer to the computer (discussed in “Connecting a Parallel Printer” on page 23)
- ❖ set up your program to work with the printer (discussed below)

These steps must be done only once. If you'll be using more than one printer or changing printers, you'll need to set up your programs to run with the additional printer(s).

Setting Up Windows to Work with Your Printer

When you turned your computer on for the first time, the Windows Setup program offered you the opportunity to introduce Windows to your printer. Read this section if you didn't have a printer at that time, or want to set up a different printer.

Setting up a printer involves choosing a printer driver. This special program acts as a translator that turns your work into a form the printer can understand. This section describes how to select a printer driver in Windows. If you're using any non-Windows programs, you'll also need to set up a printer driver for each of those programs. Refer to your program's documentation for more information.



The Windows printer drivers are contained on the Windows diskettes, created with Master Disk Creator. If you haven't created or bought these diskettes, do so now. Master Disk Creator is described in “Create or Purchase Master Diskettes” on page 29.

To select a printer driver in Windows, follow these steps:



1 Choose the Control Panel icon in the Main program group.

2 In the Control Panel, choose Printers.

Windows opens the Printers dialog box.

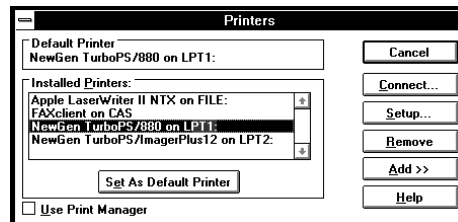

A sample Printers dialog box

3 Choose Add to show a list of available printer drivers.

4 Scroll through the List of Printers, by clicking on the box in the scroll bar and dragging it down, until you find yours.

If your printer is not listed, it probably came with its own printer driver diskette. Refer to your printer documentation for installation instructions.

5 Select your printer and choose Install.

6 Insert the diskette requested by the prompt and choose OK.

Your printer is added to the Installed Printers list.

If Windows displays an error message indicating that you inserted the wrong diskette, insert the next lower diskette. For example, if Windows originally asked for disk 7, insert disk 6. With some printers, particularly PostScript printers, you may need to insert two diskettes.

7 Choose Set As Default Printer.

- 8 Choose Close to close the Printers dialog box.
- 9 Choose Exit from the Control Panel Settings menu to close the Control Panel.

You're ready to print.

Printing Your Work

Once you have set up your printer and software correctly, it requires only a simple action to print a file from within a Windows application. Follow these steps:

- 1 Turn your printer on, if it's not already on.
- 2 Choose Print from the File menu of your Windows application.

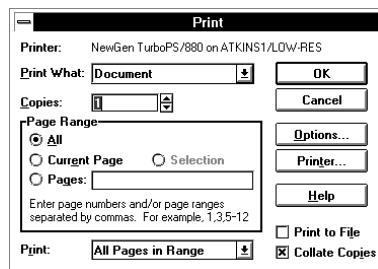

A sample Print dialog box

- 3 Choose OK to print.

That's all there is to it. Depending on your application, you may see different messages indicating the status of your print job.

How to Prepare Diskettes for Use

Formatting makes it possible to use a diskette. You don't really need to know what's going on when you format a diskette, but if you're interested, the details are covered in "How Does a Disk Store Information?" on page 200.

You can buy two types of diskettes: preformatted and unformatted. If you've purchased preformatted diskettes, you don't need the information in this section because the diskettes' manufacturer has taken care of the process for you. If the package doesn't say anything about formatting, your diskettes are probably unformatted.

This section describes the simplest way to format a diskette. For more options, and an explanation of the other items in the Format dialog box, see your Windows documentation.

To format a diskette, follow these steps:

- 1 Make sure the external diskette drive is connected.**
- 2 Insert a write-enabled diskette into the diskette drive.**

The tab at the left corner of the diskette should cover the square hole (see the illustration on page 30).



Formatting a disk erases all information currently on the disk. Do not format a disk unless you're sure it's blank or contains only files you no longer need.



- 3 Choose the File Manager icon in the Program Manager Main program group.**

Program Manager opens the File Manager.

- 4 Choose Format Disk from the Disk menu.**

File Manager displays the Format Disk dialog box. If you're using 1.44MB (high-density) diskettes, all the settings are already correct, so go to step 6.

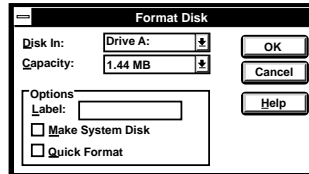

The Format Disk dialog box

5 Use the Capacity drop-down list box to set the correct capacity for your diskette.

Double-density diskettes have a capacity of 720KB, high-density diskettes have a capacity of 1.44MB.

6 Choose OK.

File Manager asks you to confirm the command.

7 Choose Yes to continue.

File Manager formats the diskette. A counter indicates the progress. When the format is finished, File Manager displays a dialog box indicating that your diskette is ready for use.

8 Choose OK to close the dialog box.

How to Copy Something To a Diskette

Diskettes provide an easy means of transferring files from one computer to another. Copying a file to a diskette also gives you a backup copy in case something happens to the original on your hard disk. This section describes how to use File Manager to copy a file from the hard disk to a diskette.

Let's assume that you want to copy your AUTOEXEC.BAT and CONFIG.SYS files onto a diskette. This actually isn't a bad idea—these important files may change when you install new programs and it's good to have a record of their original contents.

To copy these files to a diskette, follow these steps:

- 1 **Make sure the external diskette drive is connected.**
- 2 **Insert a formatted diskette into the diskette drive. If you're unsure how to format a diskette, refer to “How to Prepare Diskettes for Use” on page 62.**
- 3 **Choose the File Manager icon in the Main program group.**

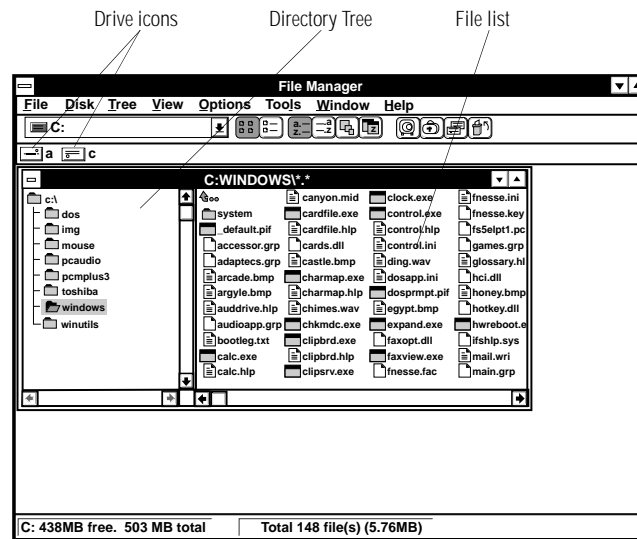

The File Manager window

Windows opens the File Manager window. You'll be using several parts of this window, so take a moment to find them now. The **drive icons**—currently C is highlighted—let you select a disk drive. The **directory tree** shows the directory structure of the current disk and the **file list** shows the files in that directory.

- 4 **Choose the c: drive icon at the top of the directory tree.**

This selects the root directory of the hard disk and shows the files in that directory.

- 5 **In the file list, click on AUTOEXEC.BAT to select it.**

Notice how the filename is now highlighted.

- 6 While holding the **Ctrl** key, click on **CONFIG.SYS** to select it also.

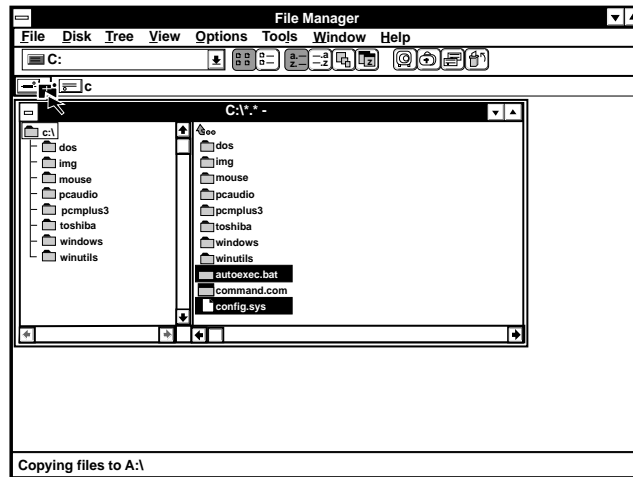

Copying files to a diskette

- 7 Click on one of the selected files and, while holding the primary button, drag the pointer to the drive icon for the A drive.
- 8 When the a: drive icon is highlighted, release the primary button.

File Manager asks if you really want to copy the files.

- 9 Assuming you do, choose **Yes**.

File Manager copies your files to the diskette.

How to Back Up Your Work on Diskettes

Murphy's law applies to everything—even computers. Therefore, it's a good idea to make a copy of everything on your computer's hard disk and store it in a safe place. This is called backing up your files. That way, if you somehow press the Delete key accidentally, you'll be able to recover your files quickly and easily.



NOTE

Murphy's Law: If anything can go wrong, it will, at the worst possible moment.

Your computer comes with Microsoft's Windows backup program, Microsoft Backup, pre-installed on the hard disk. Other backup programs are available at many computer stores.

This section tells you how to use Microsoft Backup to back up all the files on your hard disk. Complete information on Microsoft Backup, including instructions for backing up only a portion of the files on your hard disk, is in your MS-DOS documentation.



NOTE

Backing up all the files on your hard disk takes a considerable amount of time and lots of diskettes. However, in the unlikely event that you lose some or all of the information on your hard disk, you'll be glad you spent the time.

To back up all the files on your hard disk to diskette, follow these steps:



Backup

- 1 Double-click the Microsoft Backup icon in the Microsoft Tools program group in Program Manager.**

You see the Microsoft Backup window.

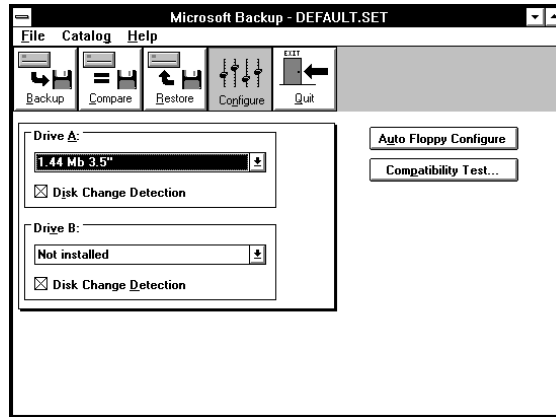

The Microsoft Backup window

- 2 **Click on the Backup icon at the left side of the window.**
- 3 **In the Backup From: section of the window, double-click C: to select your computer's hard disk.**

Microsoft Backup indicates that all files on the C drive will be backed up. The lower right portion of the window shows the number of files and estimates of the number of diskettes and amount of time required for the backup.

- 4 **In the Backup To: section of the window, click the down arrow to show a list of available drives. Choose A: to select the computer's diskette drive.**
- 5 **Choose Start Backup to start the backup procedure.**

Microsoft Backup displays the Backup Progress window. This window provides a way to monitor the progress of your backup job, prompts you to insert additional diskettes and displays other information.

- 6 **Insert diskettes as Microsoft Backup prompts you to do so.**

Make sure you label your diskettes as indicated on the screen. If your diskette is not formatted, Microsoft Backup will format it for you.

7 When the backup is finished, choose Exit from the File menu to close Microsoft Backup.

If you need to quit the backup before it is finished, choose Cancel.

8 Once you've created a backup of your entire hard disk, it's a good idea to make occasional backups of your new and changed files. Information on doing this is available through the Microsoft Backup Help menu.

To restore information from your backup diskettes to your hard disk, use the Restore menu in Microsoft Backup. Check the Microsoft Backup Help text for information on restoring files.



When you're restoring files, Microsoft Backup prompts you if you try to overwrite a file that already exists on the hard disk. Make sure the backup version is the one you want before overwriting the existing file.

How and When to Turn the Computer Off

To turn the computer off, press and hold the power button until you hear a beep.

It's a good idea to turn your computer off when you're not using it for an extended length of time. However, there are several things to keep in mind when you want to turn off the power:

- ❖ Turn Resume Mode on before you turn the power off. The next time you turn the computer on, you'll return to where you left off. If you're using the battery to run the computer, this also saves power. To turn Resume Mode on, follow the steps in "Starting Again Where You Left Off" on page 91.

- ❖ Don't turn the power off if the disk-in-use light on the indicator panel is on. Doing so may damage your hard disk or diskette drive.
- ❖ If Resume Mode is turned off, close Windows before you turn the computer off. Make sure you wait until you see a system prompt before pressing the power button. Turning the computer off before Windows returns you to a system prompt may produce unpredictable results.

Caring for Your Computer

Take care of your computer and your computer will take care of you. It sounds like a cliché, but it's true. This section offers a few easy tips on looking after your computer.

Cleaning the Computer

To keep your computer clean, perform the following tasks regularly:

- ❖ Clean the exterior case of the computer with a lightly dampened cloth.
- ❖ To clean the LCD, dilute a glass cleaner by adding an equal amount of water. Spray a small amount of the diluted cleaner on a cloth and gently wipe the screen.



CAUTION

Keep liquid, including cleaning fluid, out of the computer's keyboard, speaker grill and other openings. Never spray cleaner directly onto the computer. Never use harsh or caustic chemical products to clean the computer.

- ❖ Ask your Toshiba dealer for suggestions for appropriate cleaning products.

Moving the Computer

As a notebook computer, the Portégé 610CT is built to withstand reasonable shock and vibration. Before carrying or transporting your computer, remember these points:

- 1 Make sure all disk activity has ended (the drive indicator light stops glowing).**
- 2 Turn the computer off.**
- 3 Disconnect the AC adapter.**
- 4 Disconnect the external diskette drive.**
- 5 Disconnect all external optional devices.**
- 6 Close the display panel.**



NOTE

Do not pick up the computer by its display panel or by the back (where the ports are located).

For long trips, transport the computer in a carrying case. You can purchase a carrying case for your Portégé 610CT computer from your Toshiba dealer or through the Toshiba Accessory Catalog.

Before You Go to a Computer Store...

If you're new to computers, buying computer hardware and programs can be a confusing experience.

This chapter provides advice and explains what you need to know to purchase programs and devices that will work with your Portégé 610CT computer.

Buying Programs

The entertainment, business and personal programs you can buy are almost endless.

What Types of Programs Can I Buy?

The following sections describe some types of programs that may fit your needs.

If You're a Writer

Almost everyone needs a word processor. This includes professional writers as well as others who use computers for daily correspondence.

If you want to go beyond working with text and create a book, an advertisement or a newsletter you'll need a desktop publishing program.

If you are a public speaker, a presentation package can help you design professional-looking overheads, handouts, questionnaires and announcements.

If You Want to Draw

If you are a graphics artist or a creative artist, a variety of flexible two- and three-dimensional drawing programs are available. Some require a tablet connected to your computer through the serial port.

If You're an Accountant or Financial Analyst

There are a number of outstanding spreadsheet programs on the market. In addition, personal and professional accounting software is a category you should investigate.

If You're a Designer

Your computer dealer can introduce you to a variety of sophisticated design programs including programs to design a garden, or to build or remodel a house, as well as the more common Computer Aided Design (CAD) tools.

If You're a Researcher or Student

Online services such as CompuServe, America Online and Prodigy and access to the Internet provide almost endless resources for conducting professional research.

In addition, you can purchase dictionaries, and other reference materials on disk for your own personal library.

Understanding the Information on the Box

In addition to listing the features of the program on the box, the manufacturer usually gives its system requirements.

Below is an actual example of the system requirements for a multimedia program. Your Portégé 610CT computer meets all of these requirements.

“Requires: Microsoft Windows 3.0 with Multimedia Extensions or Microsoft Windows 3.1, and Windows 3.0-compatible hardware”

“Recommended: 386- or 486-based DOS-compatible computer, 4MB of RAM, 80MB hard disk, SVGA graphics card and monitor, SoundBlaster/Pro or 100% compatible sound card, a mouse or other pointing device”

The following sections explain each of the characteristics above.

Windows Compatibility

The Portégé 610CT computer comes with Windows for Workgroups 3.11.

Processor and DOS Compatibility

The Portégé 610CT computer has a 90MHz (megahertz) Intel Pentium microprocessor. It will run programs requiring up to 90MHz of speed and an 286, 386, 486, or Pentium processor.

The underlying operating system is Microsoft DOS (MS-DOS).

Memory

The Portégé 610CT computer comes with 8MB of Random Access Memory (RAM). Unless you've added additional memory, use this number when evaluating program requirements. Some programs may have two memory numbers: an amount which is essential for running the program and a recommended amount for better performance.

Hard Disk

The Portégé 610CT computer comes with a 686MB hard disk drive. Although this capacity well exceeds the 80MB stated in the system requirements example, it is the amount of available hard disk that matters. Much of your hard disk may be filled with programs and data.

To determine the available space on your hard disk, follow these steps:



- 1 From Program Manager, choose the File Manager icon in the Main program group.

Program Manager opens File Manager.

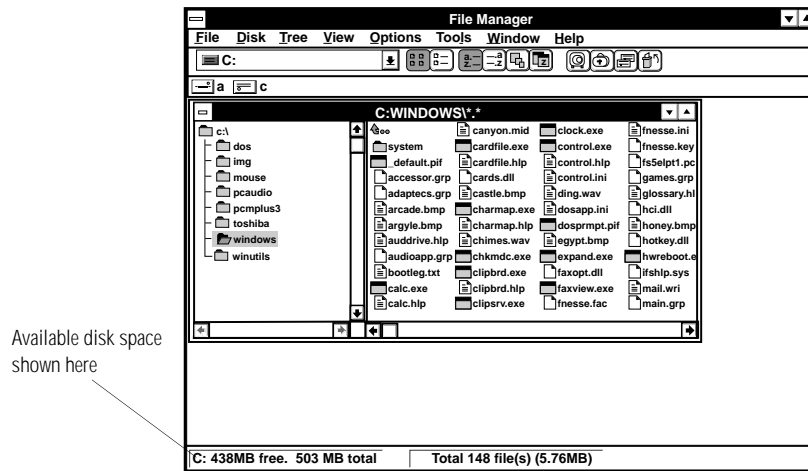

The File Manager window

- 2 Click the drive icon for the C drive.

File Manager lists the amount of free space in the bottom left corner of the File Manager window. This number is listed in megabytes (MB). See “How Big is a Megabyte, Anyway?” on page 201 for more information on megabytes.

Graphics Card

A graphics card is also called a display adapter. It may be a board installed in a desktop computer or a chip, as in the Portégé 610CT. Program requirements are generally listed by the type of adapter or the maximum resolution the adapter supports.

The Portégé 610CT display adapter is compatible with the VGA (Video Graphics Array) and SVGA (Super VGA) standards. The adapter has a maximum resolution of 1024 x 768. For programs requiring resolutions higher than 640 x 480, you'll probably want to use an external monitor. See "Using an External Monitor" on page 131 for more information.

Sound Card

Your computer has a SoundBlaster/Pro compatible sound card that provides microphone and headphone jacks and a volume control dial.

Pointing Device

The AccuPoint is a pointing device that performs all the functions of a mouse.

If a program requires a joystick, you'll have to add one, and possibly an adapter, to your system. Talk to your dealer to find out which joysticks are compatible with your Portégé 610CT computer.

Tips on Buying Programs

Before you buy:

- ❖ It's a good idea to see a demonstration of the program.
- ❖ Talk to friends and your company's computer experts about the programs they recommend.

- ❖ Make sure you have enough space available on the hard disk.
For more information, see “Hard Disk” on page 76.
- ❖ Make sure your computer has enough memory.
For more information, see “Memory” on page 75.

Installing Programs

The installation process differs for each program. In general, you should make a backup copy of the program diskettes and use your backup to install the program. The next section describes how to do this.

The installation program copies the files from the hard disk to a directory on your drive C. Installation programs may update your configuration files: AUTOEXEC.BAT, CONFIG.SYS and WIN.INI.



To keep your computer virus-free, scan all diskettes before you install a new program on your computer. See “Viruses and How to Cure Them” on page 153 for information on scanning diskettes.

For an explanation of how to install your program, follow the instructions in the program's documentation.

Creating a Backup Copy of Program Diskette(s)

You'll need one blank, formatted diskette for each program diskette you have to copy.

Follow these steps:

- 1 In File Manager, choose Copy Disk from the Disk menu.**

File Manger prompts you to insert the source disk.

- 2 Insert the diskette you're copying from into the diskette drive and choose OK.**

File Manager begins to copy the diskette.

- 3 **When File Manager prompts you, swap between the source diskette (the one you're copying from) and the destination diskette (the one you're copying to).**
- 4 **Store the original diskettes in a safe place.**

Buying Hardware

In addition to the basic system requirements, some programs require devices such as a CD-ROM drive, modem or printer. These items are available as add-on devices for your Portégé 610CT computer.

What Kind of Devices Can I Buy?

Many devices are available as PC cards. For more information about these cards, see "Little Cards that Do Big Things" on page 105.

The Toshiba Accessories Catalog lists the add-on devices you can purchase from Toshiba. Talk to your dealer about these Toshiba options and other third-party devices.

This manual also lists a large number of available options. To find these, try looking in the Index under "devices."

Tips on Buying Hardware

- ❖ If a device is cheaper than you think it should be, it may be an older version. On the other hand, depending on your needs, an older version may suit you just fine.
- ❖ Check the warranty and support policy.

Taking Your Computer on the Road

Probably the main reason you bought your Portégé 610CT computer was so you could use it in a variety of places. Of course, some of the places you'll be using it may not have a convenient power source.

This chapter describes all the aspects of running your computer on battery power.

Toshiba's Energy-Saver Design



Toshiba is a partner in the Environmental Protection Agency's (EPA) Energy Star Program. As an Energy Star Partner, Toshiba has determined that this product meets the Energy Star guidelines for energy efficiency.

The Portégé 610CT computer enters a low-power standby state when it is not being used, thereby conserving energy and saving money in the process. It has a number of other features that enhance its energy efficiency.

Many of these energy-saving features have been set by Toshiba. By leaving these features active, your computer can operate at its maximum energy efficiency.

Running the Computer on Battery Power

The Portégé 610CT computer contains a removable lithium ion battery pack that provides power when you are away from an AC outlet. You can recharge the battery many times. If you spend a lot of time on the road, you may also purchase additional batteries, giving you the potential of many more working hours away from a power source.

To charge the battery, plug the computer into a live wall socket. The battery charges when the computer is on or off. It takes approximately three hours to charge the battery with the computer off, or approximately eight to ten hours when the computer is on. There is also an optional battery charger that charges up to three batteries at the same time. See “Charging More than One Battery at a Time” on page 102 for more information about the battery charger.

Aside from the battery pack that powers the computer, there are two additional batteries: the backup battery and the real-time clock (RTC) battery. These batteries quietly go about their business in the background, you never have to worry about them. If you're really curious about these batteries, see “What Other Batteries Does the Computer Have?” on page 200.

Monitoring Battery Power

The computer's battery light gives you an indication of the current battery charge. The possible states of the battery light are:

- ❖ Green indicates a full charge.
- ❖ Orange indicates the battery is charging.
- ❖ Flashing orange indicates that the charge is running low.

Toshiba's MaxTime program also contains a battery gauge that lets you check how much time you have before the power runs out. You can set MaxTime so that it is always visible, providing a constant reminder of your current battery state. This section describes how to use MaxTime to monitor the battery charge. To learn more about MaxTime, read the description of MaxTime features which starts on page 247.

The computer calculates the remaining battery charge as it operates, based on your current rate of power use.



NOTE

The battery discharges approximately 15% per day when you don't use it.

The computer drains battery power more quickly at low temperatures. Check your remaining charge frequently if you're working in temperatures below 50 degrees Fahrenheit.

Opening the Battery Gauge



The battery gauge window is the first screen you see when you open MaxTime. To open MaxTime, choose the MaxTime icon in the Toshiba Utilities program group.

MaxTime displays a window showing the battery gauge:

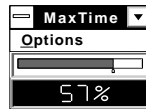

The MaxTime battery gauge window with both modules displayed

The illustration above shows the battery gauge in two different forms. The next section describes how to choose between these forms.

Changing the Appearance of the Battery Gauge

The battery gauge comes in two different flavors, called modules. Each provides the same information in a different way:

- ❖ The Bargraph module displays the current battery charge as a horizontal bar graph.
- ❖ The Percent Remaining module displays the current battery charge as a percentage of battery capacity.

To set the module(s) you want displayed, follow these steps:

1 Choose Display from the MaxTime Options menu.

MaxTime opens the Display dialog box.

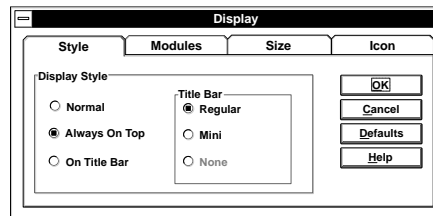

The Display dialog box

2 Choose the Modules page by clicking on the Modules tab.

MaxTime displays a screen showing the available modules.

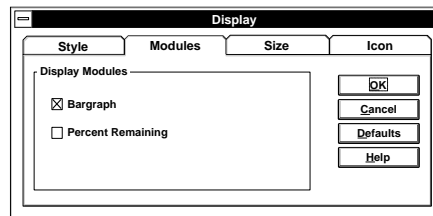

The Modules page

- 3 Click the checkbox next to each of the modules you wish to include in the battery gauge.**

You may select one or both of these modules. If you don't choose any modules, MaxTime displays the Bargraph module.

- 4 Choose OK to save your changes, exit the dialog box and return to the battery gauge.**

The battery gauge now shows the module(s) you selected.

Keeping the Battery Gauge Visible at All Times

When you first open the MaxTime battery gauge, it acts as a normal Windows program. Opening other programs may cover the battery gauge. If you prefer to see the battery gauge at all times, change the Style setting in MaxTime.

The Style option has these settings:

- ❖ Normal sets the battery gauge to act as a normal Windows program. Other programs may display on top of the battery gauge.
- ❖ Always on Top displays the battery gauge on top of all other Windows programs. This gives you a constant reminder of how long you have before running out of power.
- ❖ On Title Bar places the battery gauge on the title bar of the active window. This also displays the battery gauge at all times.

To set the battery gauge to display above all your other Windows programs, follow these steps:

- 1 Choose Display from the MaxTime Options menu.**

MaxTime opens the Display dialog box.

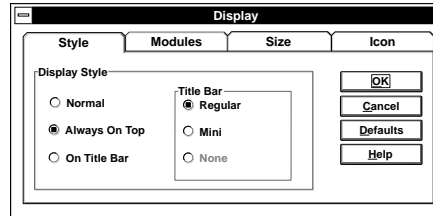

The Display dialog box

2 Click the checkbox next to the option you want.

If you don't select any of the options, the computer selects Normal.

3 Choose OK to save your changes, exit the dialog box and return to the battery gauge.

MaxTime displays the battery gauge in the way you selected.

What to Do When Your Computer Doesn't Know the Battery Charge

When you insert a fresh battery, your computer may not be able to calculate the battery's charge immediately. In this case, you may want to estimate the battery charge yourself. To do this, follow these steps:



1 In Windows, open MaxTime (if it isn't already running) by choosing the MaxTime icon from the Toshiba Utilities program group.

MaxTime displays the battery gauge window.

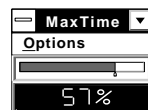

The MaxTime battery gauge window

2 Choose Set Battery Charge from the MaxTime Options menu. This menu item is only available if the system does not know the current battery charge.

MaxTime opens the Set Battery Charge dialog box.

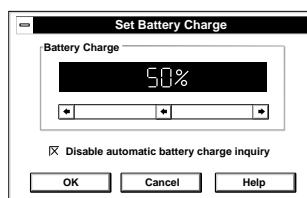

The Set Battery Charge dialog box

- 3 Click and drag the slider left or right to set the estimated battery charge.**
- 4 Choose OK to accept your change and exit the dialog box.**

The battery gauge window changes to reflect the charge you set.

What to Do When the Battery Alarm Sounds

Don't panic.

The Portégé 610CT computer has three alarms, designed to give you sufficient warning before your battery becomes fully discharged. Two of the alarms, the Low Battery Alarm and the Critical Battery Alarm, function only when you're running Windows and MaxTime is open (although MaxTime may be minimized). The third, the Emergency Battery Alert, operates at all times.

This section describes the three battery alarms, what they mean and how to set each one to fit your personal computing style.

Going . . . the Low Battery Alarm

If MaxTime is open, it warns you when you're beginning to get low on battery power. MaxTime beeps once and displays the Low Battery Alarm warning. This means you have less than 20% battery capacity remaining, unless you've changed this level.



The Low Battery Alarm warning

This warning is just a reminder that the battery charge is a finite resource that can eventually run out. Unless you've told the system to display this message at a really low power level, you don't need to do anything at this point.

To close the Alarm dialog box, choose OK. To change the level of charge that sets off this warning, see “Setting the Alarms” on page 89.

Going . . . the Critical Battery Alarm

If MaxTime is open, it warns you when you're getting fairly low on battery power. MaxTime beeps once and displays the Critical Battery Alarm warning. This means you have less than 10% battery capacity remaining, unless you've changed this level.

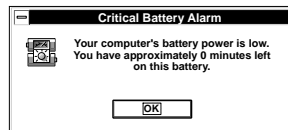

The Critical Battery Alarm warning

When this alarm goes off, start planning your remaining battery time carefully. No frantic actions are required yet, but it's a good idea to begin to think about what you absolutely must do before you find a place to plug in the AC adapter or turn the computer off.

To close the Alarm dialog box, choose OK. To set the level of charge that sets off this warning, see “Setting the Alarms” on page 89.

Gone. . . the Emergency Battery Alert

OK. Now it's serious. When the battery runs down and you have only about five minutes of time left, the computer starts beeping continuously. If MaxTime is open, it also displays the Emergency Battery Alert.

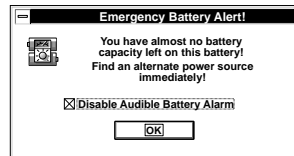

The Emergency Battery Alert

When you reach this point, plug the computer into a live power outlet or save all your files and turn the computer off immediately. Doing this ensures that you won't lose any work and also provides relief to everybody around you who's getting tired of the beeping sound from your computer.

If you don't manage to plug the computer in or turn it off before the battery completely runs out of power, the computer turns off automatically. Don't panic, all is not lost. Before shutting down, the computer automatically turns on Resume Mode (more fully described on page 91). Resume Mode keeps track of where you were so, when you turn the power on again, you can continue where you left off.

The computer's backup battery will keep this information in memory for about eight hours before it too runs out of power. So, the clock is ticking. If you ever want to see those unsaved files again, replace the battery or find a power outlet before eight hours are up.

Setting the Alarms

The Low Battery and Critical Battery alarm sound when the remaining battery charge reaches threshold power levels. The Low Battery Alarm is initially set to 20% of battery capacity. The initial threshold for the Critical Battery Alarm is 10% of battery capacity.

If these threshold levels don't fit your needs, you can use MaxTime to change them. To set the threshold levels for the Low Battery and Critical Battery alarms, follow these steps:

1 Choose Alarms from the MaxTime options menu.

MaxTime displays the Alarms dialog box.

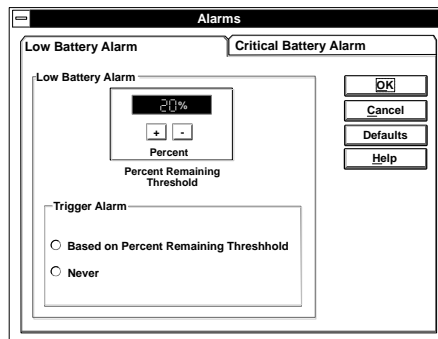

The Alarms dialog box

- 2 Switch to the desired page by clicking on the tab for the alarm you want to set.**
- 3 To change the Percent Remaining Threshold, click the + or - buttons.**
- 4 To turn on the alarm, choose Based on Percent Remaining Threshold.**
To turn off the alarm, choose Never.
- 5 Choose OK to save your settings and return to the Max-Time battery gauge window.**

Adjusting the Alarm Volume

You can change the volume at which the system alarms sound by using the Alarm Volume hotkey, Fn + F4.

To adjust the alarm volume, press and hold Fn, then press F4. Continue pressing F4 to cycle through the alarm volume settings: Off, Low, Medium, and High (in that order). The system beeps for each setting to demonstrate the volume. When you have selected the desired volume, release Fn.



Make sure to continue holding Fn while you press F4. Each time you press Fn + F4 once and release, the alarm volume is set to Off.

Starting Again Where You Left Off

If you want to turn your computer off for a while but don't want to spend all the time it normally takes to start your computer up again, Toshiba's Resume Mode feature is for you. Resume Mode acts as an electronic bookmark, storing the current state of the computer, including all your open files and programs, in memory until you turn the computer on again.

Resume Mode uses power supplied by the backup battery to store this information. If the backup battery ever discharges completely, your information is lost. What this means to you is that, although Resume Mode will store your open files, you should still save all your work before you turn the computer off.

There are three ways to turn Resume Mode on and off:

- ❖ Use a special key combination (hotkey) to turn on Resume Mode from the keyboard.
- ❖ Use MaxTime to turn on Resume Mode in Windows.
- ❖ Use TSETUP to turn on Resume Mode in MS-DOS. TSETUP is described in "TSETUP" on page 273.

The following sections describe how to turn Resume Mode on and off with a hotkey and in MaxTime.

Using a Hotkey

To select Resume Mode with a hotkey, follow these steps:

- 1 **Press Fn + F3 to display the power-up pop-up window.**



The power-up pop-up window

- 2 **While continuing to press Fn, press F3 until you select Resume Mode.**
- 3 **Release the Fn key.**

You're now in Resume Mode.

Using MaxTime

MaxTime lets you select Resume Mode when you're using Windows. Follow these steps:

- 1 **From the MaxTime battery gauge window, choose Machine Settings from the MaxTime Options menu.**

MaxTime displays the Machine Settings dialog box.

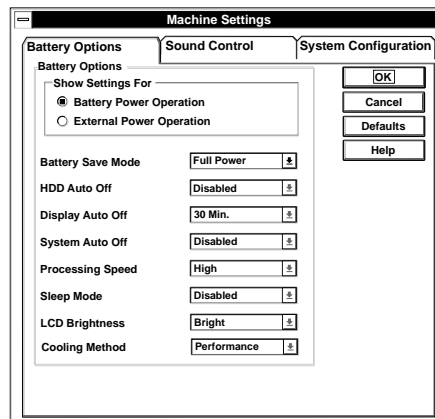

The Machine Settings dialog box

- 2 **Switch to the System Configuration page by clicking the System Configuration tab.**

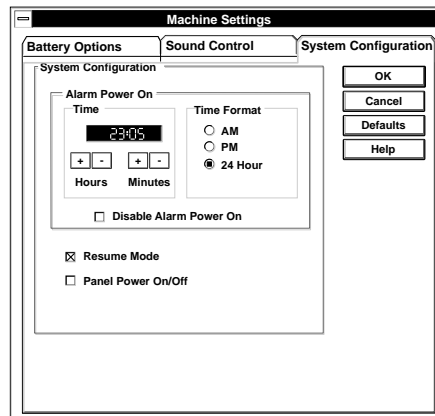

The System Configuration page

- 3 **Click on the checkbox next to Resume Mode. An X in this box turns Resume Mode on. An empty box turns Resume Mode off.**
- 4 **Choose OK to save your settings and return to the Max-Time battery gauge window.**

Replacing Batteries

When your battery runs out of power, you have two options: plug in the computer or replace the battery with a charged spare, if you have one. You may also need to replace the battery if it becomes damaged or wears out after long years of use.

To replace the battery, follow these steps:

- 1 **Turn the computer off.**
- 2 **Close the display.**
- 3 **Turn the computer over.**

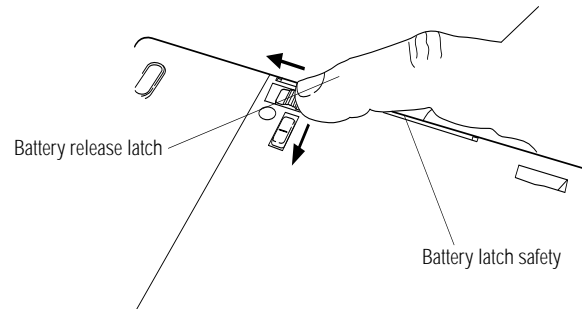

Releasing the battery

- 4 Locate the battery latch safety and slide it towards the center of the computer.**
- 5 Locate the battery release latch next to the PC card slot cover and slide it towards the back of the machine.**

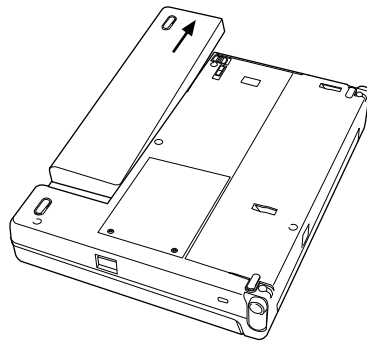

Removing the battery

- 6 The battery moves to the right enough for you to pull it out of the computer by grasping it at the right edge.**
- 7 Wipe the battery terminals of the charged battery with a clean cloth to ensure a good connection.**
- 8 Carefully place the charged battery in the slot, aligning it with the guides.**
- 9 Slide the battery into the computer.**

- 10 Push gently until you hear a click, indicating the battery is connected.**
- 11 If the battery does not have a full charge, plug in the computer.**

Disposing of Used Batteries Safely

Eventually, after years of faithful service, you'll need to retire your battery and replace it with a new one. Under federal, state and local laws, it may be illegal to dispose of old batteries by placing them in the trash.

The materials that came with your computer may include an insert regarding the disposal of batteries. If not, check with your local government for information on where to recycle or dispose of old batteries.

If you cannot find the information you need, contact Toshiba for assistance. See "Contacting Toshiba" on page 235 for information on contacting Toshiba offices around the world.

Conserving Power

It's a fact: if you're running your computer on battery power, your battery will eventually discharge. However, by using Toshiba's power-saving options, you can greatly increase the amount of time before you need to recharge the battery.

These options have been combined into preset battery save modes. Using these modes lets you choose between maximum power savings and peak system performance. You may also set individual power-saving options to suit your own tastes.

The following sections describe how to choose a battery save mode and discuss each power-saving option.

The Easy Way—Choosing a Battery Save Mode

There are two battery save modes:

- ❖ Full power provides maximum system performance, while using the most power.
- ❖ Low power provides maximum battery life by reducing overall system performance.

The following table shows the battery save option settings for both battery save modes:

<i>Battery Save Options</i>	<i>Full Power</i>	<i>Low Power</i>
HDD Auto Off	Disabled	3 Min.
Display Auto Off	30 Min.	3 Min.
System Auto Off	Disabled	30 Min.
Processing Speed	High	Low
CPU Sleep Mode	Disabled	Enabled
LCD Brightness	Bright	Semi-Bright
Cooling Method	Performance	Quiet

There is also a User Setting that lets you set the power-saving options individually.

You may set the battery save mode with a hotkey, in MaxTime (if you're working in Windows) or in TSETUP (if you're working in MS-DOS). This chapter covers setting the battery save mode with a hotkey and in MaxTime. Using TSETUP to set the battery save mode is discussed in “TSETUP” on page 273.

Using a Hotkey

To select a battery save mode with a hotkey, follow these steps:

- 1 Start MaxTime, if it's not already running.**

- 2 Press **Fn + F2** to display the battery save pop-up window.



The battery save pop-up window

- 3 While continuing to press **Fn**, press **F2** until you select the desired battery save mode.
- 4 Release the **Fn** key.

You're now in the selected mode.

Using MaxTime

To select a battery save mode in MaxTime, follow these steps:

- 1 From the MaxTime battery gauge window, choose **Machine Settings** from the MaxTime Options menu.

MaxTime displays the Machine Settings dialog box, with the Battery Options page on top.

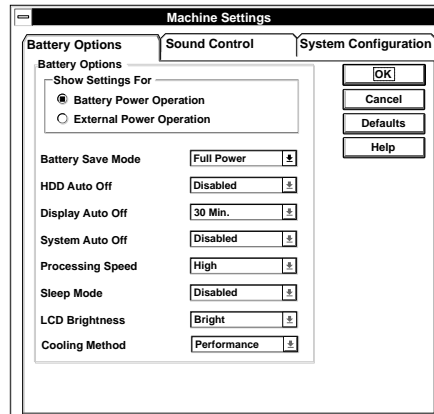

The Machine Settings dialog box

- 2 Click the arrow next to the **Battery Save Mode** option list box to view the available settings.

- 3 Click the desired setting to highlight it.
- 4 Choose OK to save your settings and return to the Max-Time battery gauge window.

Setting Battery Save Options on Your Own

If you set the battery save mode to User Settings, you can set your computer's power-saving options individually. For example, if you want the computer's processing speed set to its maximum level but want to take advantage of all the other power-saving features, this is the way to do it.

This section describes each of the power-saving options. Settings that save power are indicated with an Energy Star logo.

HDD Auto Off

This option saves power by temporarily shutting down the hard disk if it hasn't been accessed for a set period of time. The drive turns back on the next time the computer reads from or writes to it. You have eight choices:

Disabled turns the option off.



1 Min, 3 Min, 5 Min, 10 Min, 15 Min, 20 Min and 30 Min turn the hard disk drive off if the computer hasn't accessed the hard disk for the time set.

Display Auto Off

This option saves power by temporarily shutting down the display if you have not used the keyboard or AccuPoint for a set period of time. To turn the display back on, press a key or move the AccuPoint. You have eight choices:

Disabled turns the option off.



1 Min, 3 Min, 5 Min, 10 Min, 15 Min, 20 Min and 30 Min blank the display if you haven't used the keyboard or AccuPoint for the set time.

If you're using an external monitor, Display Auto Off blanks the monitor after the selected time.

System Auto Off

This option saves power by turning the computer off if it hasn't been used for a set period of time. This option is available only if Resume Mode is turned on. You have seven choices:

Disabled leaves the computer on until you use the power button to turn it off.



10 Min, 20 Min, 30 Min, 40 Min, 50 Min and 60 Min turn the computer off if you haven't used it for the time set.

Processing Speed

This option sets the speed at which the computer processes information. You have two choices:



Low sets a lower processing speed and saves power.

High sets the computer to its maximum processing speed.

CPU Sleep Mode

This option temporarily shuts down the computer's central processing unit (CPU) when it is inactive. Pressing a key, moving the AccuPoint or a signal from a device returns the processor to its normal operating speed. You have two choices:



Enabled turns CPU Sleep Mode on.

Disabled turns CPU Sleep Mode off.

LCD Brightness

This option saves power by reducing the brightness of the computer's display.



Semi-bright reduces the brightness of the display.

Bright sets the display to its maximum brightness.

Cooling Method

The computer's central processing unit (CPU) is a Pentium chip that runs so fast it has a tendency to overheat. To protect the CPU from overheating, each chip comes with its own fan.

There are two ways to cool the CPU: the system can turn on the fan and/or slow the processor to a speed that does not cause it to overheat.

Turning the fan on may cause you to hear a barely audible fan noise. On the other hand, slowing the processor may make your programs run slower.

This option lets you control how the system cools the CPU.



Quiet slows the CPU first, then turns the cooling fan on as needed. This method minimizes the noise caused by the fan.

Performance turns the cooling fan on first, then lowers the CPU speed as needed. This method ensures the system works at top speed as long as possible.

Look After Your Battery

It doesn't take much effort, but by treating your battery right you can make sure it provides maximum power storage for a long time. The following sections offer tips on how to take care of your battery.

Five Steps to a Happy Battery

- ❖ Don't leave the computer plugged in and unused for more than five hours at a time. When you're not going to use the computer for a long period, disconnect the AC adapter and let the battery discharge completely.
- ❖ Alternate between batteries if you have a spare.
- ❖ Don't touch the metal terminals on the battery with another metal object.

- ❖ Always turn your computer off when you're replacing the battery.
- ❖ Follow the steps in the next section to maintain your battery's maximum potential.

Maximizing Your Battery's Potential

Follow these steps every week or so to keep your battery operating at its maximum level:

- 1 Set the battery save mode to Full Power by following the steps in “Conserving Power” on page 95.**
- 2 Turn the computer off.**
- 3 Disconnect the AC adapter.**
- 4 Turn the computer on and leave it on until the battery completely discharges and the system automatically shuts down.**
- 5 Connect the AC adapter and leave the computer off until the battery is fully charged (approximately two and a half hours).**

The battery light glows green when the battery is fully charged.
- 6 Remove the battery and wait 30 seconds.**
- 7 Reinsert the battery and leave the computer off until the battery is again fully charged.**

Additional Power Options

Depending on the amount of time you spend away from external power sources, the capacity of one battery pack may be sufficient for your needs. However, if you need more portable power, Toshiba provides two options:

- ❖ You can buy extra battery packs.
- ❖ You can buy a battery charger that charges more than one battery at a time.

Additional Battery Packs Extend Battery Time

Having one or more extra batteries gives you the opportunity to replace a discharged battery with a charged spare. This can greatly increase the amount of time you can work without having to find a power outlet.

Charging More than One Battery at a Time

The optional battery charger provides an alternative to charging the battery in your computer. This is especially useful if you have one or more extra batteries. You can charge your spare(s) in the battery charger while continuing to work on the computer. While the battery charger requires a power source, it provides an easy way for you to take more than one charged battery with you when you travel.

Charging the Computer's Battery in Your Car

The Noteworthy Auto Adapter (NW8DIL) lets you plug the computer into the cigarette lighter of your car. This is a great way to charge the computer's battery between stops.

How About a Carrying Case?

When you're on the road, you'll probably want a way to carry your computer with you. Toshiba offers four choices of carrying cases for the Portégé 610CT computer:

- ❖ a sturdy twin fabric carrying case (NWCCAFB)
- ❖ a leather attaché (PC-PA 1050L)
- ❖ a woven fabric case in black, gray, or green (NWCCUFB-GY-GN)
- ❖ a backpack-style case (PC-PA 180B)

All of these cases help protect the computer from the bumps and bruises of normal travel. They also provide plenty of extra space for manuals, AC adapters and diskettes.

Ask your dealer to order your Noteworthy case directly from Toshiba. You can also order it through the *Accessories Catalog* that came with your computer.

Little Cards that Do Big Things

PC cards (PCMCIA-compatible) greatly increase the capabilities of your computer. These cards pack all the performance of full-sized expansion cards into a case the size of a credit card.

Your computer comes with a PC card slot that lets you take advantage of these little cards. You can install up to two Type I or Type II cards or one Type III card (Type III cards are much thicker). When you buy a PC card, check the package for the Type of card you're buying.

This chapter describes the different types of PC cards, tells you how to install PC cards and provides general tips on using them. Since each card is different, you'll have to read your cards' documentation to use the card, but this chapter will help you get started.



If your PC card came with a diskette, read "Programs that Make Your PC Card Work" on page 107 before installing any of its programs. The programs on the diskette may conflict with pre-installed Toshiba files designed specifically for your computer.

What Do PC Cards Do?

New PC cards are being introduced every day. Among the PC cards currently available are:

- ❖ Modems and fax/modems
- ❖ Network adapters
- ❖ Removable hard disk drives
- ❖ SCSI adapters
- ❖ Global Positioning System (GPS) receivers

Some PC cards combine the functions of several different cards. One popular example is a PC card that combines a fax/modem with a network adapter. These are handy if you want to get the most out of your PC card slots.



PC card technology has changed considerably over the last few years and it's important that your card is current with the times. Check the package to make sure the PC card you buy conforms to the PCMCIA 2.1 standard (or later). Cards not conforming to this standard may work with your computer, but they are likely to be much more difficult to set up and use.

Cards You Can Buy from Toshiba

Toshiba's Noteworthy PC cards are specifically designed to work with your Portégé 610CT computer and are available from your Toshiba dealer. Noteworthy PC cards include:

- ❖ Fax/Modems
- ❖ Token ring network adapters
- ❖ Ethernet network adapters

- ❖ SCSI-II adapters
- ❖ Removable hard disk drive

Programs that Make Your PC Card Work

PC cards require Card and Socket Services software. While this title sounds rather complex, it's nothing to worry about—it's merely a set of programs that acts as a translator between the PC card and the computer, and makes hot swapping (switching cards while the computer is on) possible.

Toshiba Card Manager is Toshiba's version of Card and Socket Services software. It comes pre-installed on your computer's hard disk and your CONFIG.SYS file contains the appropriate commands to load the Card and Socket Services drivers into memory.

The *Card Manager User's Guide*, included with your computer, provides more information about Toshiba Card Manager.



Non-Toshiba PC cards may come with another version of Card and Socket Services software. If you install this version, it will conflict with the Toshiba Card Manager files that are already installed. Since Toshiba Card Manager is specifically designed to work with your Toshiba computer, Toshiba recommends that you use only Toshiba's version of Card and Socket Services software.

PC Cards and Resume Mode

Toshiba's Card and Socket Services software is designed to support Resume Mode. If you use another manufacturer's Card and Socket Services software instead, the system may not recognize your PC card when you turn the computer on in Resume Mode.

Press Ctrl + Alt + Del to restart the computer and the system will recognize the card.

Hot Swapping

One of the really great things about PC cards is that you can replace one PC card with another even while the computer is on. This is called “hot swapping.” For example, if you want to switch between a hard disk and a modem PC card, you can do it while you’re working without turning the computer off and back on again.

Hot Swapping Cautions

While you can insert a PC card at any time, applying a bit of common sense about when you remove a card will make your computing life much happier. Just remember not to remove a card while it’s in use. You probably won’t break anything, but you could lose valuable information. Some examples:

- ❖ Do not remove a modem card while it is communicating.
- ❖ Do not remove a hard disk card while the system is accessing the card.
- ❖ Do not remove a SCSI card while any of the SCSI devices is operating.
- ❖ Do not remove a network card while you are connected to the network.

Inserting PC Cards

OK. You’ve bought your first PC card and want to install it. This section describes how to install the card.

Before you insert your PC card, read through the documentation that comes with the card to see if you need to do anything before you insert it.



Toshiba Card Manager provides the Card and Socket Services for your PC card. This version of Card and Socket Services is designed for optimum performance with your Portégé 610CT computer. If you're using a non-Toshiba PC card, don't install the Card and Socket Services for that card until you've tried the Toshiba version first.

Your PC card slot has two card sockets. You may insert a Type I or Type II card into either socket. You may insert a Type III card into the lower socket only. Inserting a Type III card takes up all the space for both sockets—you cannot have a Type III card installed with any other card.

To insert a PC card, follow these steps:

- 1 Locate the PC card slot cover on the right side of the computer.**

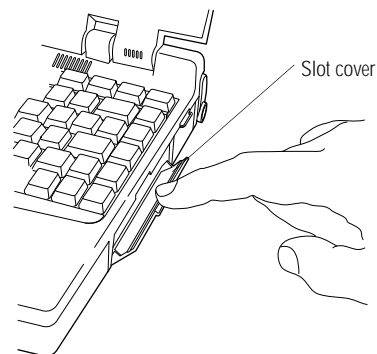

Opening the PC card slot cover

- 2 Open the slot cover.**

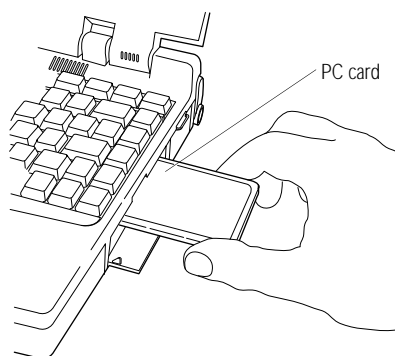

Inserting a Type II PC card into the PC card slot

- 3 Insert the PC card.**
- 4 When the card is almost all the way into the slot, push firmly, but gently, to ensure a firm connection with the computer.**

Do not force the card into position. When the card is fully seated, an eject button will pop out: the top button for the top socket and the bottom button for the bottom socket.

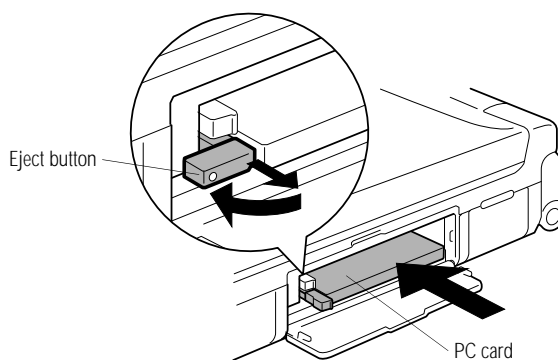

Folding the eject button

- 5 Pull the eject button out slightly and fold it to the left.**
- 6 Close the slot cover.**

Setting Up Your PC Card for Your Computer

Some PC cards, such as many fax/modems, are ready to use as soon as you install them. Others, such as hard disk cards, network cards and SCSI adapters, require some additional work to set them up for your computer.

Expansion cards for desktop computers often have external switches or other components that need to be set before you install the card. PC cards, because of their size, have no such switches. Instead, you set up the card in Toshiba Card Manager.

Read the documentation that came with your device, looking for anything that you need to set before you can use the card. When you find something that you need to set, refer to the Toshiba Card Manager documentation to see if you can use Toshiba Card Manager to set the necessary value.



Remember, Toshiba Card Manager is designed specifically to work with your computer. Use it whenever possible to make changes in your PC card setup.

Setup Example

This section takes you through the setup process in Toshiba Card Manager, using an ATA hard disk card as an example.

Use this section as you would a map. It shows how to get to where you want to go, but can't tell you what to do when you get there. For more information about the setup process, refer to the *Toshiba Card Manager User's Guide*.

To set up Toshiba Card Manager to operate with your card, follow these steps:

- 1 Close Windows, if it's running, and return to the system prompt.**
- 2 Type c: and press Enter.**

3 Type `cd\pcmplus3` **and press** Enter.

If the Toshiba Card Manager files are in a different directory, type that directory name instead of PCPLUS3.

4 Type `pcmsetup` **and press** Enter.

5 Press a key to clear the welcome screen and continue.

PCMSETUP displays the Installation Mode screen.

6 Use the arrow keys to highlight Advanced Mode and press Enter.

PCMSETUP asks you to enter the number of PC card slots on your computer.



Your Portégé 610CT has a single PC card slot with two PC card sockets. PCMSETUP identifies each socket as a separate slot.

7 Make sure the number of slots is 2 and press Enter.

PCMSETUP asks if you want to use PC cards in Windows.

8 Press Y.

9 Define the path for your Windows files. Either:

❖ **Press** Enter **to accept the default Windows path.**

❖ **Change the directory to the one containing your Windows files before pressing** Enter.

PCMSETUP displays the Advanced Setup screen.

10 Make sure the IRQ is set to 11 and press Enter.

PCMSETUP displays the Flash File System screen.

11 Press N **to continue without installing Flash File support.**

PCMSETUP displays the Communication Ports screen.

12 Select Yes and press Enter.

PCMSETUP displays a list of COM ports.

13 Press Enter to accept the current settings.

PCMSETUP displays the ATA Socket screen. This is where the important stuff starts.

14 Select Yes and press Enter.

PCMSETUP asks you to enter the ATA Window Address.

15 Press Enter to accept the current setting.

PCMSETUP asks you to enter the ATA drive spin down time.

16 Press Enter to accept the current setting.

PCMSETUP asks if you want to install ATA support for socket 0 (the lower one).

17 Select Yes and press Enter.

PCMSETUP asks you to enter the number of partitions for an ATA hard disk in the lower socket.

18 Press Enter to accept the default setting of one partition.

PCMSETUP asks if you want to install ATA support for socket 1 (the upper one).

19 Select No and press Enter.

PCMSETUP displays a list of PC cards that it does not set up automatically. Since ATA cards are set up automatically, press Enter to close this screen.

PCMSETUP asks if you want to save your setup information.

20 Select Yes and press Enter.

21 Press Ctrl + Alt + Del to restart your computer with the new settings in effect.

When you insert your ATA hard disk card into the PC card slot, the computer will recognize the card.

Removing a PC Card

To remove a PC card, follow these steps:

- 1 Open the PC card slot cover on the right side of the computer.**

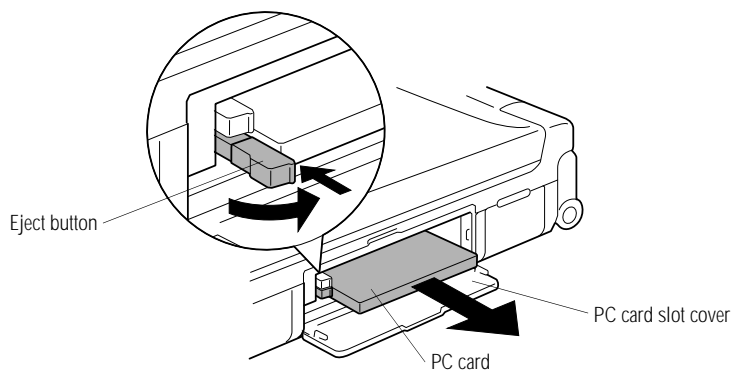

Ejecting a PC card

- 2 Unfold and press the eject button that corresponds to the slot in which your PC card is installed.**

The top button releases a card in the upper slot. The bottom button releases a card in the lower slot.

- 3 Grasp the edges of the PC card and slide it out of the slot.**
- 4 Close the PC card slot cover.**

Connecting to the World

You've used your computer at 30,000 feet and in your den while watching television. Now you want to send e-mail (electronic mail), explore the world of the Internet or transmit data back to your office while you're on the road.

This chapter describes what you'll need, how to prepare your system for communications and some of the interesting things to do on the Internet. The chapter concludes with tips on connecting your computer to a network.

What You'll Need

To communicate with the outside world you'll need:

- ❖ a modem
- ❖ a telephone line
- ❖ communications software

Choosing a Modem

A modem converts the digital signals from a computer into the analog signals required by a voice-grade telephone line. Two types of modems work with your Portégé 610CT computer. You can use either:

- ❖ a PC card modem that slips into one of your computer's PC card slots.

Some PC cards combine a modem with a fax and/or the capability to operate as a telephone answering machine. These offer a convenient way to greatly expand your communications potential without adding multiple devices to your computer.

Cards that support the cellular network let you communicate from your car or a cellular telephone.

- ❖ an external modem connected to the computer through the serial port.

Which Modem is for Me?

You would use an external modem only while in your office or at home. For traveling you need a PC card modem. Really, the only reason to use an external modem is if you already own one and don't want to invest in a PC card modem right now.

You can purchase a Noteworthy PC card modem designed to work with your Toshiba computer. Ask your dealer to order one directly from Toshiba, or order one through the *Accessories Catalog* provided with your computer.

Faster is Better

Modems support a variety of speeds from 300 bits per second (bps) to 28.8 megabits per second (for use on regular telephone lines). In general, you should buy the fastest modem you can afford.

The faster the modem, the quicker you'll be able to send and receive messages, files and other online services. Transmission speed has a lot to do with how easy the modem is to use.

Where to Buy a Modem

Toshiba sells Noteworthy PC card fax/modems specifically designed to work with your computer. Refer to the *Accessories Catalog* for more information on how to purchase one. Your dealer may be able to sell you other fax/modem and fax/voice/modem PC cards.

Installing a PC Card Modem

If you purchased a PC card modem, install it according to the instructions in "Inserting PC Cards" on page 108.

After you've installed the card, connect the telephone cable from the card to the wall jack.

Connecting an External Modem

To connect an external modem to the computer, follow these steps:

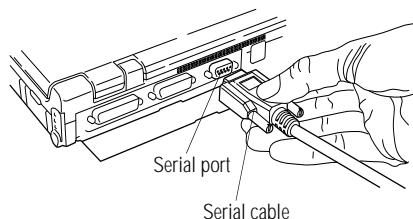

Connecting the cable to the serial port

- 1 Plug one end of the serial cable into the modem and the other end into the computer's serial port.**
- 2 Plug one end of the modem's power cable into the modem and other end into a live wall outlet.**
- 3 Plug one end of the telephone cable into the line out jack on the modem and the other end into the wall jack.**

Make sure you turn the modem's power on before you attempt to use it.

Connecting to a Telephone Line

Once you have the modem, you need a voice-grade telephone line with a standard modular phone jack. As the business world becomes more accustomed to busy executives and their portable computing needs, it's becoming much easier to find these jacks. For example, many hotels that cater to business travelers have one or more phone jacks in each room.

If you are using the telephone line at home, disable call waiting before you connect through the modem. Call waiting interrupts transmission.

If you have a modem that is capable of transmitting over the cellular network you can use any cellular line. Always stop and remain stationary while transmitting data over a cellular phone. Transmitting data while you move will cause problems when the cellular network hands off the call to the next cell.

Using a Communications Program

There are three types of communications programs:

- ❖ general purpose communications programs
- ❖ remote control programs
- ❖ specialized communications programs

This section discusses these types of programs and gives some general information you'll need to get a communications program up and running.

General-Purpose Communications Programs

A general-purpose communications program lets you use the modem to call another computer for the purpose of sending and receiving messages or files.

Your computer comes pre-installed with a general-purpose communications program, the Windows Terminal. Terminal is a simple program and somewhat limited. See your Windows documentation for more information about how to use Terminal.

If your needs are more complex than Terminal can handle, there are a number of options available to you. For example, your modem may have come with a communications program. Also, general-purpose communications programs are available at most computer stores.

You can use this type of program to dial into an online service, such as CompuServe, or the Internet. If you use a general-purpose communications program for this purpose, you must be familiar with how to use the online service or be conversant with UNIX (to use the Internet).

For more information about online services, see “Using Online Services” on page 124. For more information about connecting to the Internet see “Using the Internet” on page 124.

Telecommuting with Remote Control Programs

A remote control program lets you operate a computer over a telephone line. With this type of program, you can call in from home and actually work as if you were in your office. You can access all of the drives on your office computer or network, and transfer files to and from your Portégé 610CT computer.

There are a number of remote control packages available at most computer stores. You can also telecommute using the Internet. For more information on the Internet, refer to “Using the Internet” on page 124.

Specialized Software

As more and more people join online services and the Internet, online service providers and independent companies are offering programs designed to make accessing the online service or the Internet easier.

Installing the Program

Whichever type of program you choose, follow the installation instructions contained in the program's documentation.

Assigning the Communications Port

You must tell the program what the COM port is and configure the computer for the same COM port.

If you're using a PC card modem, the communications port is already set to COM2. If you're using an external modem, the serial port should be configured as COM1.



Assigning the COM port is the way you connect your communications program to the physical port on your computer. The serial port can be COM1 or COM2. The name you assign to the physical port must be the same as the name selected in your program, or the modem won't work.

Sending a Fax

Sending a fax through your computer's fax/modem is almost as simple as printing a document. All you need is a fax program. One may have come with your PC card. Otherwise, commercial fax programs are available at computer stores.

Once your fax program is installed, Windows treats it as if it is another printer. To send a fax:

- 1 Choose Print Setup from within the program you're using to prepare your document.**
- 2 Select your fax printer driver from the list of available printers.**
- 3 Choose Print.**

What happens next depends upon your fax program. However, it's something like this: your program prompts you for a telephone number and gives you an opportunity to attach a standard cover sheet.

- 4 Choose Send to send the fax.**

Using an Electronic Bulletin Board Service

The idea of using bulletin boards is an old one. Everybody's seen them. Big flat pieces of cork with lots of papers pinned to them. They're used to post messages, advertise a business or just to read some amusing stuff that somebody else had put up.

With the rise of the computer age, bulletin boards have gone electronic. Now there are thousands of electronic bulletin board services (BBSs) around the world. Like their mundane counterpart, these services let you post messages for friends or questions to which a wide variety of people can respond. Many BBSs also offer software (programs) that you can copy to your computer (called downloading).



When you download software from a BBS, it's a good idea to check it for computer viruses. See "Viruses and How to Cure Them" on page 153.

Most BBSs serve a particular interest group and are run by an individual or small group of people. For example, a science fiction BBS may have messages from people looking for out-of-print books and offer a few sample sections of new works.

Most computer companies offer a BBS as one way to provide customers with software updates and answers to their questions. Toshiba's 24-hour BBS offers product support assistance and is a good resource if you have questions about your computer. Complete information about accessing Toshiba's BBS is found in "Toshiba's Bulletin Board Service" on page 236.

Some BBSs charge for their services. Also, smaller BBSs may not have toll-free telephone numbers. You'll have to add the cost of a toll call into the amount you pay to use the BBS.

For a list of BBSs, ask your dealer or computer store.

Using Online Services

You've probably heard of some of the more popular online services, such as CompuServe, Prodigy and America Online. Think of online services as super BBSs. They provide easy access to home shopping, travel arrangements, stock quotes and forums on a huge variety of topics.

You can send messages to other members, post questions on almost any subject and access a variety of reference materials. Most online services also have vast libraries of software that you can download for your own use.

Like many BBSs, online services cost money. Some charge a monthly fee, while others charge for the time you're connected to the service. Still others combine a monthly fee with additional online charges for specialized services.



If you're using an online service that charges for online time, make sure to pay attention to the amount of time you're connected to the service. It's easy to get so involved that you lose track of the time.

Most online services offer starter packs. You can obtain these from a computer store or by calling the service. For a toll free number to call, watch television advertisements or look in PC magazines.

Using the Internet

The Internet (INTERNational NETwork of computers) is a huge computer network. Actually, it's really a network of networks. Universities, government agencies, commercial offices and other sites around the world are connected, giving users on one network access to information on all the other connected networks.

What You Can Do on the Internet

The Internet offers a huge variety of information and experiences. The world is, quite literally, at your fingertips. For example, you can:

- ❖ send electronic mail (e-mail) to any of the millions of Internet users around the world.
- ❖ participate in thousands of specialized “newsgroups” covering almost any topic through the Usenet, a network of user groups.
- ❖ carry on a real-time conversation with someone in the next building or around the world.
- ❖ join a mailing list and receive articles published by others on specific topics.
- ❖ publish your own articles and circulate them to a mailing list.
- ❖ look through a virtually limitless number of electronic publications.
- ❖ play games with other users.
- ❖ download an enormous amount of free software (don’t forget to check for viruses, following the steps in “Viruses and How to Cure Them” on page 153).
- ❖ work at home on a computer many miles away or communicate with the office using video conferencing.
- ❖ access information over the Internet’s Wide Area Information Service (WAIS).
- ❖ search the World Wide Web (WWW) using hypertext links for interesting network sites and information.

Where Do I Sign Up?

To use the Internet as an individual, you need an account with a service provider. Some service providers also provide software that makes the Internet easier to use. The easiest way to get on the Internet is to buy one of the programs that comes from a service provider.

When you dial-up the service provider's Internet site for the first time you will be asked to supply your credit card number. This initial process opens an account for you with the service provider.

What Does it Cost?

Although "traveling" on the Internet is free, accessing it through a service provider costs money. Most software packages for the Internet come with some free access time. After you've used up this time you may pay hourly charges in addition to a monthly charge.

If you use a service provider that can only be accessed over a private telephone network such as SprintNet, you'll have to pay additional telephone charges for access to the telephone network.

Make sure you ask about all the charges before you choose a software package and service provider.

How Do I Learn More About the Internet?

Explaining how to use the Internet goes far beyond the scope of this manual. However, there are a number of excellent books available that can help you get started. Each book presents the Internet in a slightly different way, telling you how to access information that is of particular interest to the author. Skim through a number of books to find the one that seems to point you in the direction you want to go.

Connecting to a Network

Although your computer is designed to be carried around on your travels, there may be times that you want to tap into your company's network. This section gives tips on how to connect your computer to an existing network.

Since most of the details in connecting to a network depend upon the network operating system your company uses and the type of cabling or wireless system installed, this section gives only a brief overview specific to your Portégé 610CT computer. Talk to your network administrator for assistance in getting up and running on your network.

What Do I Need to Connect to a Network?

Before you can connect to a network, you need to purchase a network adapter card. These come in two forms that will work with your Portégé 610CT computer:

- ❖ PC network adapter card (PCMCIA-compatible)
- ❖ Parallel network adapter

The PC card runs faster, but takes up one of your PC card slots. The parallel adapter leaves more space for PC cards and can be connected so that you can still use a parallel printer.

Making the Connection

Connecting to a network requires these general steps:

- 1 Disable Resume Mode by pressing Fn + F3 to display the power-up pop-up window.**
- 2 While continuing to hold Fn, press F3 until boot mode is highlighted.**
- 3 Release the Fn key.**
- 4 Insert the PC card into the slot.**
- 5 Update your CONFIG.SYS file with the memory window (exclusion) used by the network card.**

Refer to the network card's documentation for the proper memory window.

- 6 Restart the computer by pressing Ctrl + Alt + Del.**

- 7 Follow the instructions in “Setting Up Your PC Card for Your Computer” on page 111 to configure the network card.**
- 8 Update your AUTOEXEC.BAT or other batch file with the network commands that load the appropriate network drivers and log you onto the network.**

You only need to do this step once. Ask your network administrator to help you.
- 9 Run the batch file that contains the network drivers and logon script.**

Networks and Resume Mode

If you're connected to a network, don't turn the computer off when it's in Resume Mode. The next time you turn the computer on, the system will lock, disconnecting you from the network. If this happens, press the reset button to restart your computer.

If it is important to you to be able to use Resume Mode even while physically connected to a network, you must log off the network and remove all the network drivers from memory (in reverse order) before you turn the computer off.

Using Your Computer on Your Desktop

Your Portégé 610CT computer was designed to be easy to carry around and use while you travel. However, it's also powerful enough to use as your primary desktop computer.

This chapter describes how to connect several optional devices that can make your Portégé 610CT computer look at home on your desk.

Using an External Monitor

You can easily attach an external monitor to your computer. Some external monitors display more information than the computer's built-in screen. Also, having an external monitor makes the entire display bigger.

Connecting an External Monitor

To connect an external monitor, follow these steps:

1 Turn the computer off.

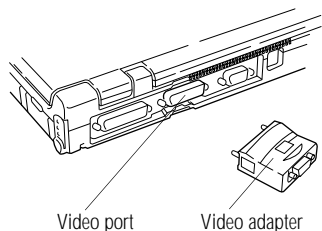

Connecting the video adapter

2 Connect the video adapter that came with your computer to the video port on the back of the computer.

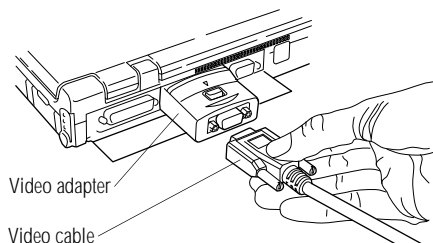

Connecting the video cable

3 Connect the monitor's video cable to the video adapter.

4 Turn the external monitor on.

5 Turn the computer on.

The computer uses the external monitor.

6 If your external monitor can display high-resolution video modes (greater than 640 x 480), you can take advantage of this feature by changing the video mode. To do this, see “Changing the Display Mode” on page 183.

Directing the Display when You Turn the Computer On

When you turn the computer on, it sends information to the external monitor. To send information to the built-in display as well, you'll need to change the setting in Hardware Setup or TSETUP. The Power On Display option has two settings:

- ❖ Internal/External sends the display to the external monitor. If no external monitor is attached, it sends information to the computer's built-in display.
- ❖ Simultaneous sends display output to both the external monitor and the built-in display. This is especially useful if you're making a presentation and cannot see the external monitor easily.

This section explains how to change the Power On Display option using Hardware Setup. To change this option using TSETUP, see "TSETUP" on page 273.

The Hardware Configuration program lets you set configuration options in Windows. To set the Power On Display option in Windows, follow these steps:



1 Choose the Hardware Setup icon in the Toshiba Utilities program group.

Hardware Setup displays the Hardware Configuration dialog box.

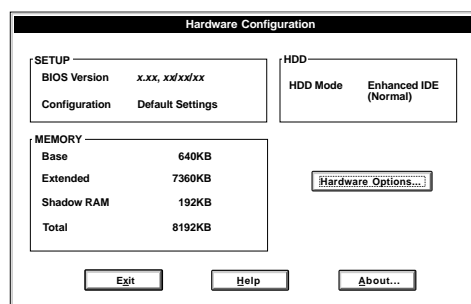

The Hardware Configuration dialog box

This box contains information about the system.

2 Choose Hardware Options.

Hardware Setup displays the Hardware Configuration Options dialog box.

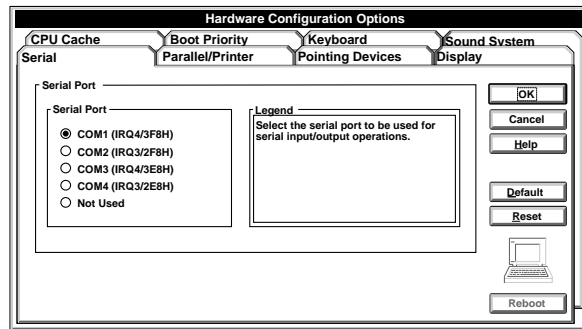

The Hardware Configuration Options dialog box

3 Click the Display tab.

Hardware Setup displays a page of display options.

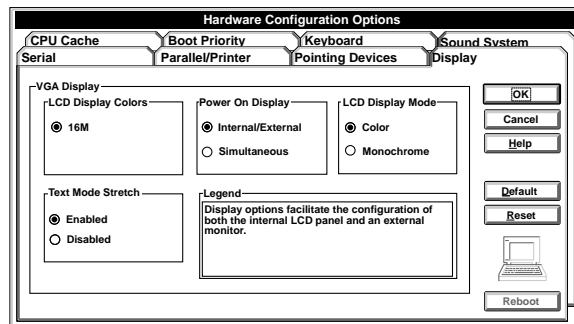

The Display page

4 Click the circle to the left of the desired Power On Display setting.

5 Choose OK.

Hardware Setup displays a dialog box asking if you want to reboot (restart) the computer.

6 Choose:

- ❖ **Yes to restart the computer immediately with your changes in effect.**
- ❖ **No, if you have programs open with unsaved files. Save your files and restart the computer using the reset button or Ctrl + Alt + Del.**

Your changes will not take effect until you restart the computer.

Using an External Keyboard

If you prefer to use a standard desktop keyboard, you can attach one to your computer through the optional Port Replicator. The Port Replicator's keyboard port supports any PS/2-compatible keyboard.

Connecting the Keyboard

To connect an external keyboard, follow these steps:

- 1 Follow the steps in “Connecting the Computer to the Port Replicator” on page 141 to attach your computer to the Port Replicator.**
- 2 Press Alt + F3.**
- 3 If Resume Mode is on, press F3 again to turn Resume Mode off.**

If you connect a keyboard while the computer is in Resume Mode, the computer will not recognize the keyboard.

- 4 Turn the computer off.**



Make sure the computer is off before you attach the keyboard. Connecting a keyboard with the computer's power on may damage the keyboard, the computer or both.

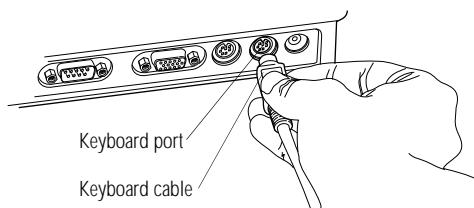

Connecting an external keyboard

- 5 **Attach the keyboard cable to the keyboard port on the back of the Port Replicator.**
- 6 **See the keyboard's documentation for additional configuration steps.**
- 7 **Turn the computer on.**

Making Your External Keyboard Pretend it Has an Fn Key

An external keyboard doesn't have the Fn key contained on the Portégé 610CT built-in keyboard. If you use the computer's hot-keys or have set up key combinations in Fn-esse, you'll probably miss these features when using an external keyboard. Don't worry: with the Fn Key Emulation option in Hardware Setup or TSETUP, you can make your external keyboard act as if it had a Fn key of its own.

For more information about Fn-esse, see "Starting Programs Faster" on page 165.

To find out how to set the Fn Key Emulation option using TSETUP, see "TSETUP" on page 273.

To set the Fn Key Emulation option in Hardware Setup, follow these steps:



- 1 **In Windows, choose the Hardware Setup icon in the Toshiba Utilities program group.**

Hardware Setup displays the Hardware Configuration dialog box.

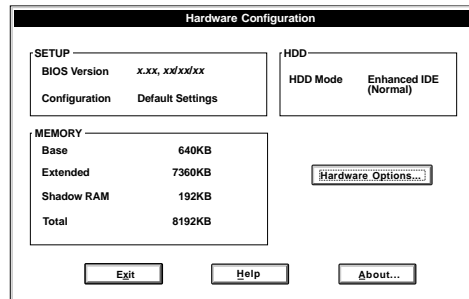

The Hardware Configuration dialog box

This box displays information about the system.

2 Choose Hardware Options.

Hardware Setup displays the Hardware Configuration Options dialog box.

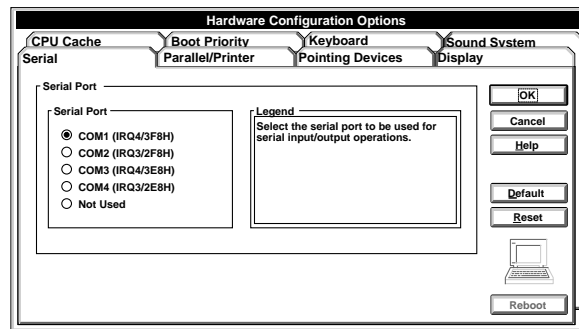

The Hardware Configuration Options dialog box

3 Click the Keyboard tab.

Hardware Setup displays a page with the External Keyboard Fn Key option.

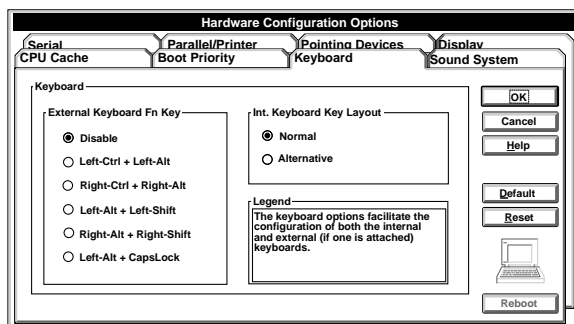

The Keyboard page

- 4 **Click the circle to the left of the desired External Keyboard Fn Key setting.**
- 5 **Choose OK to close Hardware Setup with your setting in effect.**

Using a Serial Mouse

You may want to use a mouse instead of the AccuPoint. If you do, make sure you buy a serial mouse. You may use a PS/2 mouse if you're using an optional Port Replicator. See "Using the Port Replicator" on page 139 for more information.

If you connect a serial mouse, the AccuPoint is disabled.

To connect a serial mouse, follow these steps:

- 1 **Turn the computer off.**



Only connect a serial mouse when the computer is off. Connecting a serial mouse with the computer on may damage the mouse, the computer or both.

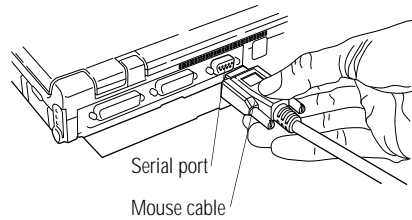

Connecting the cable to the serial port

- 2 Plug the mouse cable into the computer's serial port.**
- 3 Turn the computer on.**

The mouse is ready to use.



Your computer comes with mouse/AccuPoint drivers pre-installed. If you have purchased another type of pointing device, such as a mouse, the pre-installed drivers may not work properly with the new device. Also, the drivers included with the mouse may not work properly with the AccuPoint. If a conflict occurs between two pointing devices and their drivers, follow the instructions in "If You Need Further Assistance" on page 234 to contact Toshiba Product Support.

Using the Port Replicator

The Port Replicator port allows you to connect your Portégé 610CT computer to an optional Port Replicator. The Port Replicator is an excellent investment if you're using your computer both in and out of the office.

Imagine that you're a salesperson who frequently works away from the office. When you return to your desk, you want to be able to print reports from your computer, and use a mouse instead of the AccuPoint. Connecting cables for each of these devices every time you return to the office is time-consuming and inconvenient.

By connecting external devices to the Port Replicator instead of directly to your computer, you can leave the devices connected while you are using your computer away from your desk. When you return, you can quickly connect your computer to the Port Replicator and have immediate access to the devices.

Port Replicator Features

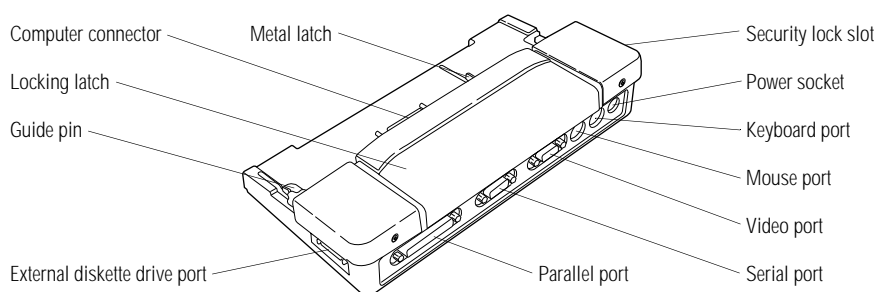

The ports of the Port Replicator

The above illustration identifies the various Port Replicator features:

The **computer connector** connects to the Port Replicator port on the back of your computer.

The **locking latch** and **metal latches** secure the computer to the Port Replicator.

The **guide pins** help align the computer with the Port Replicator, ensuring a proper connection.



Use the **external diskette drive port** to connect the external diskette drive.







Use the **security lock slot** to attach a security cable to the Port Replicator. This cable is discussed in “Applying Physical Restraints” on page 153.



Use the **power socket** to connect the Port Replicator to AC power, using a power cord and AC adapter.



Use the **keyboard port** to connect a PS/2 keyboard.

-  Use the **mouse port** to connect a PS/2-compatible pointing device.
-  Use the **video port** to connect an external monitor. This port replaces the computer's video port.
-  Use the **serial port** to connect a serial device, such as a serial printer. This port replaces the computer's serial port.
-  Use the **parallel port** to connect a parallel printer or other parallel device. This port replaces the computer's parallel port.

Connecting the Computer to the Port Replicator

To attach the computer to the Port Replicator, follow these steps:

- 1 Turn the computer off.**
- 2 Detach the external diskette drive, if it is connected.**
- 3 Remove all cables from the back of the computer.**

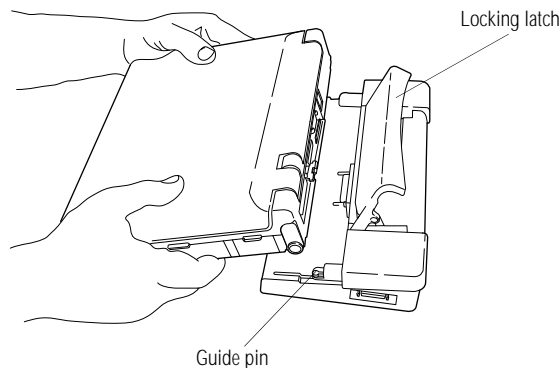

Attaching the computer to the Port Replicator

- 4 Open the computer's port cover and slide it into the slot at the lower edge of the computer.**
- 5 Lift the locking latch on the Port Replicator.**
- 6 Align the two holes on the bottom of the computer with the guide pins on the Port Replicator.**
- 7 Slide the computer into the Port Replicator.**

- 8 Gently press the locking latch down to secure the computer to the Port Replicator.
- 9 Attach the AC adapter to the Port Replicator's power socket.
- 10 Connect the power cord to the AC adapter and then to the wall socket.

To disconnect the computer from the Port Replicator, turn the computer's power off, lift the locking latch and remove the computer.

Using a PS/2 Mouse

The Port Replicator has a port for a PS/2 mouse. If you connect a mouse to this port, you may use the mouse, the AccuPoint or both.

To set how the PS/2 mouse works with the AccuPoint, follow these steps:



- 1 Choose the Hardware Setup icon in the Toshiba Utilities program group.

Hardware Setup displays the Hardware Configuration dialog box.

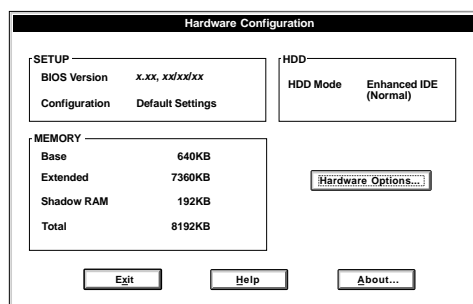

The Hardware Configuration dialog box

This box contains information about the system.

- 2 Choose Hardware Options.

Hardware Setup displays the Hardware Configuration Options dialog box.

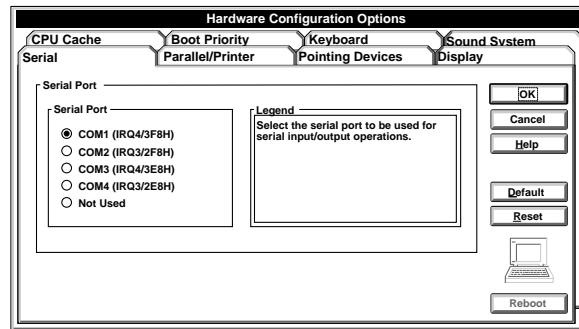

The Hardware Configuration Options dialog box

3 Click the Pointing Devices tab.

Hardware Setup displays a page of pointing device options.

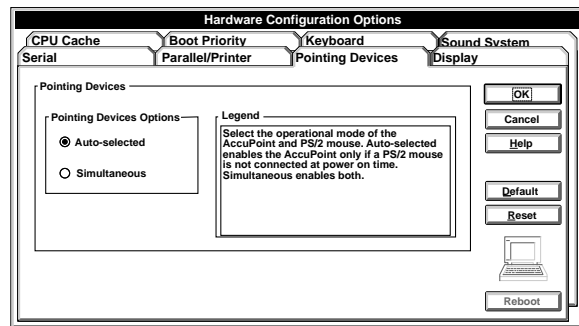

The Pointing Devices page

4 Choose the desired option.

Auto-Selected uses only the PS/2 mouse if one is connected, turning off the AccuPoint.

Simultaneous lets you use both the AccuPoint and the PS/2 mouse.

5 Choose OK.

Hardware Setup displays a dialog box asking if you want to reboot (restart) the computer.

6 Choose:

- ❖ **Yes to restart the computer immediately with your changes in effect.**
- ❖ **No, if you have programs open with unsaved files. Save your files and restart the computer using the reset button or Ctrl + Alt + Del.**

Your changes will not take effect until you restart the computer.

Keeping Your Files Safe

At some time, you'll almost certainly have files on your computer that you want to keep private. Your Portégé 610CT computer comes with several options that can help you keep your computer and files safe from unwanted intrusion.

This chapter describes the security options for your Portégé 610CT computer.

Using a Password

Setting a password lets you leave your computer, secure in the knowledge that nobody can access your files. When you set a password, you must enter the password before working on your computer.

There are two types of passwords on the Portégé 610CT computer:

- ❖ A power-on password requires you to enter the password every time you start or restart the computer.
- ❖ An instant password lets you get up and walk away from your computer for a few moments without having to turn the computer off.

Creating a Password

You create a password in TSETUP. To create (register) a password, follow these steps:

1 Exit any programs that are running and close Windows.

To close Windows, choose Exit from the File menu in Windows Program Manager, then choose OK or press Enter.

2 From the system prompt (for example, c:\>), type c:\dos\tsetup.

```

SYSTEM SETUP                                BIOS VERSION = X.XX
-----
MEMORY
Total           = 8192KB
Base            = 640KB
Extended       = 7360KB
Shadow BIOS ROM = 192KB

DISPLAY
Display Adaptor = VGA Compatible
LCD Display Mode = Color

LCD Display Colors = 256K Colors
Power On Display  = Internal/External
Text Mode Stretch = Enabled

HARD DISK
HDD Mode        = Enhanced IDE (Normal)

I/O PORTS
Serial Port     = COM1 (IRQ4/3F8H)
Parallel Port   = LPT1 (378H)
Sound System    = Address/IRQ/DMA

PASSWORD
Not Registered

OTHERS
Power-up Mode   = Boot
CPU Cache       = Enabled
Battery Save Mode = Full Power
Alarm Volume    = High
System Beep     = Enabled
Panel Power On/Off = Disabled
Alarm Power On  = Disabled
Keyboard        = Layout/Fn
Pointing Devices = Auto-Selected
Boot Priority    = FDD→HDD
Cooling Method  = Performance

↑↓→:Select items Space, BkSp:Change Values
Esc:Exit without saving Home:Set default values End:Save changes and Exit
    
```

The TSETUP screen

3 Press P to move to the PASSWORD section of the screen.

4 Press the spacebar.

TSETUP displays Password =

-
- 5 Type a password of from one to 16 characters and press Enter.**

You may use any combination of letters and numbers in your password.



Make sure you use a password you can remember easily and create a password service diskette. If you ever lose or forget your password, contact Toshiba PC Product Support (US telephone number 800-999-4273). Password service diskettes are discussed in "Protecting Against Forgetfulness" on page 149.

- 6 When TSETUP prompts you to do so, verify the password by typing it again and pressing Enter.**

If the two passwords match, TSETUP displays Registered.

If the two passwords don't match TSETUP displays Entry Error!!. Repeat steps 4 through 6 to enter the password again.

- 7 Continue with the next section to create a password service diskette.**

Protecting Against Forgetfulness

If you ever forget your password, a password service diskette lets you bypass the password when starting your computer.

To create a password service diskette, follow these steps:

- 1 Follow the steps in the previous section to create a password.**
- 2 Make sure you've attached the external diskette drive.**

3 Insert a diskette into the diskette drive.



The computer overwrites all existing information on the password service diskette. Make sure the diskette you use does not contain any important information.

4 While still in TSETUP, press End.

TSETUP asks you to confirm your choice.

5 Press Y.

TSETUP writes your password to the diskette and prompts you to remove the diskette.

6 Remove the diskette and press a key.

The computer restarts.

7 Place your password service diskette in a safe place, away from the computer.



If you forget your password and have lost your password service diskette, contact Toshiba PC Product Support at 800-999-4273.

Do not use your password service diskette for any other purpose. The password information is written in such a way that MS-DOS and Windows cannot read it. If you try to access the diskette, you'll receive an error message and will have to reset your password and create a new password service diskette.

Power-On Password

Whenever you start or restart your computer with a power-on password in effect, the computer prompts you to enter the password before it goes through its normal startup procedure. The power-on password operates whether or not the computer is operating in Resume Mode.

When your computer prompts you to enter your password, type it in and press Enter. If you enter the password correctly, the computer continues with its normal startup procedure. If you enter an incorrect password, the computer beeps. After three incorrect attempts, the beep sounds continuously until you turn the computer off.

If you've forgotten your password, follow these steps:

- 1 Make sure you've attached the external diskette drive.**
- 2 Turn the computer on with Resume Mode turned off.**

The system prompts you for your password.

- 3 Insert the password service diskette into the diskette drive and press Enter.**

The system prompts you, "Set Password Again (Y/N)?"



The password service diskette is not reusable. Once you use it, you must create a new diskette, even if you set the same password.

- 4 To enter TSETUP and reset your password, press Y. Follow the instructions in "Creating a Password" on page 148 to reset your password.**

To remove your password, press N. It will no longer be registered.

Instant Password

An instant password secures your system with a single keystroke. Use this feature when you need to leave your desk for a few minutes and don't want to turn the computer off.

To use an instant password, press Fn + F1. Pressing this hotkey freezes the keyboard and AccuPoint and blanks the screen. An instant password has no effect on an optional serial mouse or trackball.

If you have not registered a power-on password, press Enter to unlock your system.

If you have registered a power-on password, follow these steps to unlock your system:

- 1 **Press** Enter.
- 2 **Enter your password and press** Enter.

If you enter the password correctly, the computer returns to where it was when you pressed the hotkey.

Disabling a Password

To disable your password, follow these steps:

- 1 **Exit any programs that are running and close Windows.**
- 2 **From the system prompt, type `c:\dos\tsetup`.**

```

          MEMORY                      SYSTEM SETUP                      BIOS VERSION = X.XX
Total      = 8192KB
Base       = 640KB
Extended   = 7360KB
Shadow BIOS ROM = 192KB

          DISPLAY
Display Adaptor = VGA Compatible
LCD Display Mode = Color

LCD Display Colors = 256K Colors
Power On Display = Internal/External
Text Mode Stretch = Enabled

          HARD DISK
HDD Mode = Enhanced IDE (Normal)

          I/O PORTS
Serial Port = COM1 (IRQ4/3F8H)
Parallel Port = LPT1 (378H)
Sound System = Address/IRQ/DMA

          PASSWORD
Not Registered

          OTHERS
Power-up Mode = Boot
CPU Cache = Enabled
Battery Save Mode = Full Power
Alarm Volume = High
System Beep = Enabled
Panel Power On/Off = Disabled
Alarm Power On = Disabled
Keyboard = Layout/Fn
Pointing Devices = Auto-Selected
Boot Priority = FDD→HDD
Cooling Method = Performance

↑↓→:Select items Space, BkSp:Change Values
Esc:Exit without saving Home:Set default values End:Save changes and Exit
    
```

The TSETUP screen

- 3 **Press P to move to the PASSWORD section of the screen.**
 - 4 **Press the spacebar.**
- TSETUP displays Password =
- 5 **Type the existing password and press** Enter.

If you entered the correct password, TSETUP displays Not Registered.

If you entered an incorrect password, TSETUP displays Entry Error!!. Repeat steps 4 and 5 to enter the password again.

6 Press End and Y to exit TSETUP.

Your password is disabled.

Applying Physical Restraints

You can connect the optional Kensington MicroSaver Security System to deter theft. One end of this cable fits into the security lock slot on the left side of the computer. Secure the other end of the cable to your desk or other large, heavy object.

If you're using an optional Port Replicator, you'll want to purchase two of these cables: one for the computer and another for the Port Replicator.

Viruses and How to Cure Them

Over the last few years, there have been a number of computer virus scares. Immoral pranksters with too much time on their hands find some perverse pleasure in unleashing these potentially destructive programs on the general public.

Viruses, while a potential problem, need not have a devastating effect on your computer. By taking a few simple precautions, you can avoid infection. And, by making sure you have a complete backup of all your programs and data files, you can ensure a speedy recovery if you do run into problems.

This section discusses general virus protection and provides a brief introduction to the Microsoft Anti-Virus program that is pre-installed on your computer. For more information about all the capabilities of Anti-Virus, use the online Help file within Anti-Virus.

An Ounce of Prevention

There is one basic rule to avoid contact with computer viruses: don't put a program file onto your computer without scanning it first. It's even a good idea to scan brand new program diskettes.

To use Anti-Virus to scan a disk or diskette for viruses, follow these steps:



- 1 In Windows, choose the Anti-Virus icon in the Microsoft Tools program group to open Anti-Virus.**

Anti-Virus displays the Microsoft Anti-Virus screen:

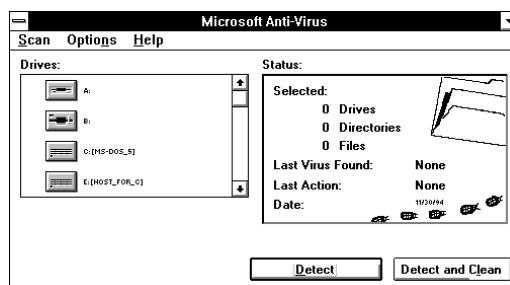

The Microsoft Anti-Virus screen

- 2 Choose one or more of the drive options. For example, if the file in question is on a diskette, choose A:.**

Anti-Virus reads the disk.

- 3 Choose Detect.**

Anti-Virus scans the computer's memory and the selected drive(s) and displays a report.

- 4 If Anti-Virus detects a virus, go on to the next section.**

A Pound of Cure

If you've scanned a disk and Anti-Virus has found a virus, follow these steps:

- 1 In Anti-Virus, choose the drive(s) with the infected file(s).**

2 Choose Detect and Clean from the Scan menu.

Anti-Virus removes the virus from the infected file.

Protecting Against Unknown Viruses

No virus protection program can keep up with all the existing computer viruses. Anti-Virus has a feature that lets you search for the presence of an unknown virus on your system.

The verify integrity procedure searches your drive for changes in the size of your program files. Since these files rarely change in size, this procedure alerts you that something may be going on in your system. While this will not catch every possible virus, most computer viruses do modify program files to some degree.

Follow these steps:

1 Choose Set Options from the Anti-Virus Options menu.

Anti-Virus opens the Options dialog box.

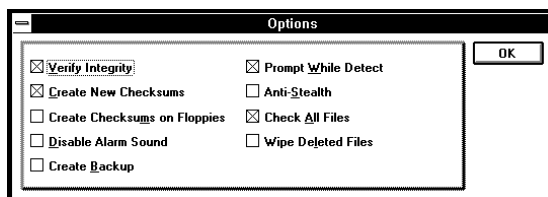

The Options dialog box

2 Click the box next to Verify Integrity.

An X appears in the box, indicating that the procedure is selected.

3 Choose OK to close the Options dialog box.

4 Perform a virus check, as described in “An Ounce of Prevention” on page 154.

Making Life Easier

Your Portégé 610CT computer is already a computing powerhouse right out of the box. You can run the most powerful business programs and work for hours away from an external power source without needing to change anything. By adding extras and using the additional built-in features of your computer, you can make your life even easier.

This chapter discusses some convenient options that are already included with your computer.

Working with Sound

Your Portégé 610CT comes with several audio programs pre-installed (in the Audio Applications program group). This section describes how to use these programs to record and play back sounds.

Audio is just one of many elements of multimedia computing. If you find you want to explore the exciting world of multimedia further, you'll need to purchase additional programs. Talk to your dealer to find out which multimedia programs will work best with your computer. Then, go for it!

Recording Sounds

You may record sounds through the built-in microphone or through an external microphone connected to the microphone jack.

Setting the Recording Level

To set the recording level, follow these steps:



- 1 Choose the Recording Control icon from the Audio Applications program group.**

Windows opens the Recording Control window.

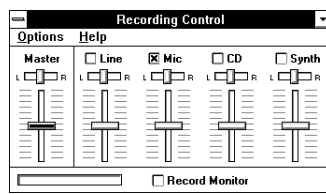

The Recording Control window

- 2 Choose the check box for the recording source you're using (in this case, the Mic check box). An X appears in the box when it is selected.**



Though the Recording Control window has options for recording from a line-in jack or CD-ROM drive, choosing these options will not have any effect.

- 3 Move the horizontal slide bar left or right to adjust the stereo balance.**
- 4 Move the vertical slide bar up or down to adjust the recording level.**
- 5 Use the Audio Recorder window to make a recording. Refer to "Using the Built-In Microphone" on page 159.**

- 6 Play back the recording to make sure the recording level is appropriate.

Using the Built-In Microphone

The easiest way to record is through the computer's built-in microphone. To do this, follow these steps:

- 1 Choose the Audio Recorder icon in the Audio Applications program group.

Audio Recorder icon

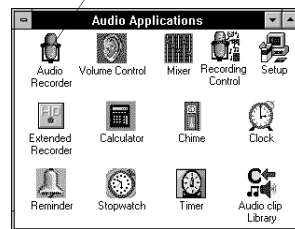

The Audio Applications program group

Windows opens the Audio Recorder window.

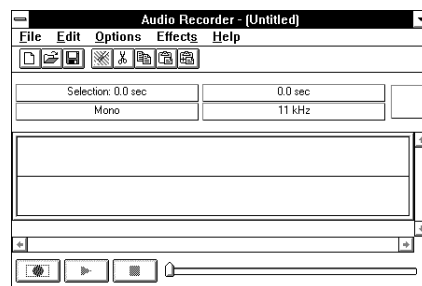

The Audio Recorder window

- 2 Choose New from the File menu.

The Sound Attributes dialog box opens:

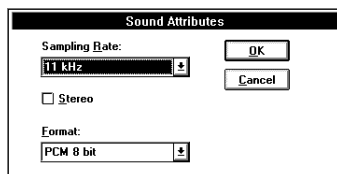

The Sound Attributes dialog box

3 Choose a sampling rate from the Sampling Rate field.

Sound files recorded with fast sampling rates have better sound quality than those recorded with slow sampling rates, but they use more memory.

4 Turn stereo recording on or off by clicking the Stereo check box. An X in the box turns stereo recording on.

5 Choose a file format from the Format field.

Uncompressed formats (PCM) produce the best sound quality, and allow you to edit the sound file before saving it.

Compressed formats (ESPCM and ADPCM) let you save disk space, although you do lose some sound quality.

6 When you have finished making selections in the Sound Attributes dialog box, choose OK to return to the Audio Recorder window.

You are ready to record a new sound file.



7 Choose the Record button. It's the red one at the bottom left of the screen.

8 Talk into the microphone.



9 When you're done recording, choose the Stop button.

The Audio Recorder window displays a graphic representation of the new sound file in its waveform display.



10 To hear what you just recorded, choose the Play button.

11 To save the file, choose Save from the File menu.

Adjusting Recording Quality

You can adjust the quality of your recordings. However, the better the quality of the recording, the more disk space the sound file will require. Experiment a bit to find a balance that fits your needs.

To adjust the recording quality, follow these steps:



Extended Recorder

1 Choose the Extended Recorder icon in the Audio Applications program group.

Windows opens the Extended Recorder window.



The Extended Recorder window

2 Choose Audio Settings from the Options menu.

3 Adjust any of the following settings: Bits per Sample, Sample Rate in Khz and Channels.

4 Experiment with the Audio Recorder to check your settings.

You may also need to adjust the recording level to achieve the desired results.

Using an External Microphone

The computer has a built-in microphone for recording sounds. To record higher quality sounds, you may wish to use an external monaural microphone.

To attach an external monaural microphone, follow these steps:

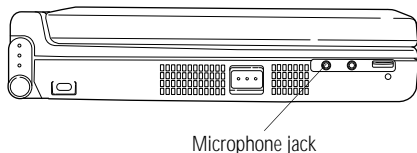

The microphone jack

- 1 Locate the microphone jack on the left side of the computer.**
- 2 Plug the microphone cord into the microphone jack.**
- 3 Turn the microphone on.**

The internal microphone is automatically disabled.

Once the external microphone is connected, the recording process is the same as for the built-in microphone. See “Using the Built-In Microphone” on page 159 for instructions.

Saving Your Recording to Disk

Once you get a recording you like, you’ll want to keep it. To save the recording, follow these steps:

- 1 In either the Audio Recorder or the Extended Recorder window, choose Save As from the File menu.**
The Save As dialog box opens.
- 2 Using the Drives, Directories, and Filename fields, choose the path and filename under which you want the file saved.**
- 3 If the file is uncompressed and you wish to save it as a compressed file, choose Options and select a format from the Compression field.**
- 4 Choose OK.**

Playing Sound Files

Your computer has a built-in speaker you can use to play back sound files. You may also connect an external device, such as headphones or externally powered stereo speakers. This section describes how to play sound files.

Using the System Speaker

To play a sound file using the system speaker, follow these steps:

- 1 **Choose either the Audio Recorder or Extended Recorder icon in the Audio Applications program group.**

Windows opens the selected program window.

- 2 **Choose Open from the File menu.**

- 3 **Select the desired sound file and choose OK.**



- 4 **Choose the Play button.**

- 5 **The sound file will play until it ends or until you choose the Stop button.**

Using External Speakers

To play back sound files on an external device such as headphones or stereo speakers, follow these steps:

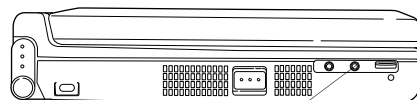

Headphone jack

The headphone jack

- 1 **Locate the headphone jack on the left side of the computer.**
- 2 **Using any necessary adapters, plug the cord from the external audio device into the headphone jack.**
- 3 **Follow the steps in “Using the System Speaker” on page 163.**

Making the System Work Faster

It's been said that there are two truths in life: you can never be too rich or too thin. Actually, there's a third: your computer can never run fast enough. Before getting excited about a newer, faster model that has just become available, read through this section.

Two options that can increase system performance noticeably are disk caching and virtual disks. The really great thing is that you don't need to go out and buy anything: Windows and MS-DOS already support these features.

Disk Caches

Reading from and writing to a disk takes time. Although it's not much time, if you're using the same information over and over again, it seems a bit ridiculous that your drive light goes on every time you type in the same command.

That's where a disk cache comes in. By converting a portion of your computer's memory to a disk cache, you can get around some of that repetitious disk access time. When the system reads information from a disk, it temporarily stores that information in the disk cache. Then, the next time that information is requested by the system, the information is already in memory and the disk doesn't become involved in the process. Since accessing memory is faster than accessing a disk, disk caching speeds up computer performance.

Both MS-DOS and Windows include the SMARTDRV disk cache program. See your MS-DOS or Windows documentation for information on using SMARTDRV. In addition, there are several other disk cache programs available. Ask your dealer about alternative disk caching programs.

Virtual Disks

A virtual disk, sometimes called a RAM disk, lets you use the computer's random access memory (RAM) to simulate a hard disk drive. Since the computer's memory has no mechanical parts, the computer can retrieve information stored on a virtual disk much faster than information stored on the hard disk.

MS-DOS and Windows both include the RAMDrive virtual disk program. See your MS-DOS or Windows documentation for complete information about RAMDrive. In addition, there are several other virtual disk programs available. Ask your dealer for information about alternative virtual disk programs.

If you have programs or data files you use frequently, copy them onto a virtual disk the same way you would copy them to a diskette. You'll notice a tremendous increase in speed when you access these files.

For an explanation of how to use File Manager to copy files, see "How to Copy Something To a Diskette" on page 64.



When you turn the system off without Resume Mode, the computer wipes out everything in memory. Since the virtual disk exists in the computer's memory, the computer also wipes anything stored on your virtual disk. Make sure you copy updated files from your virtual disk to the hard disk or a diskette before you turn the computer off without Resume Mode.

Starting Programs Faster

Normally, when you have a Windows program open and want to open a different program, you need to switch back to Program Manager or File Manager to click on the appropriate icon. Toshiba's Fn-esse program provides a quick way to open programs and documents from within any Windows program.

By assigning a key combination with the Fn key, you can:

- ❖ open a Windows program or a document in a Windows program.
- ❖ display a pop-up list of Windows programs and/or documents from which to choose.
- ❖ switch between open programs and documents.

You can assign any key that is not associated with a hotkey or a keyboard overlay. This section explains how to assign your Fn key combinations and use them to open programs and documents quickly.

Starting Fn-esse



To start Fn-esse, choose the Fn-esse icon in the Toshiba Utilities program group:

Fn-esse displays the Fn-esse window:

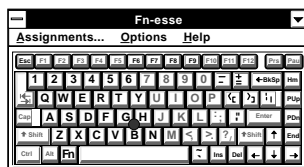

The Fn-esse window

The keys are color coded as follows:

- ❖ available keys are black
- ❖ assigned keys are highlighted
- ❖ unavailable keys are dark gray
- ❖ keys associated with a pop-up list have a small dot on the upper left corner of the key

Assigning a Key to a Program or Document

There are three ways to assign a key to open a program or document:

- ❖ drag-and-drop
- ❖ the Browse for Applications dialog box
- ❖ the ProgMan Browser dialog box

The following sections describe each of these methods. Experiment with each to find the one that best suits your tastes.

Using Drag-and-Drop

To use the drag-and-drop method of assigning a key to a program or document, follow these steps:

- 1 Open both Fn-esse and File Manager.**
- 2 Resize the File Manager window so you can see both the Fn-esse keyboard and File Manager at the same time.**

If you're unsure how to do this, refer to "Lesson 6: Changing the Size and Shape of a Window" on page 44.

- 3 In File Manager, highlight the program or document file you wish to assign to a key.**
- 4 Click and hold the primary button as you drag the highlighted item from File Manager to the key on the Fn-esse keyboard to which you wish to assign it.**
- 5 Release the primary button.**

Fn-esse displays the Add/Edit Command dialog box completely filled in to reflect the selected program or document.

- 6 Choose OK to close the Add/Edit Command dialog box with your key assignment in place.**

The program or document is now associated with the key you just selected. To open the program or document, press Fn plus the appropriate key from within any Windows program.

Using the Browse for Applications Dialog Box

To use the Browse for Applications dialog box to assign a key to a program or document, follow these steps:

- 1 Click the desired key in the Fn-esse keyboard with the secondary button.

Fn-esse displays the Assignment Type dialog box:

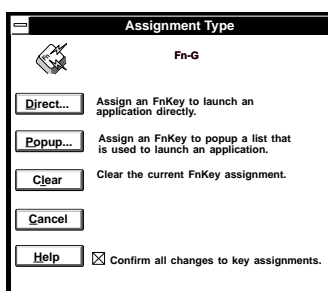

The Assignment Type dialog box

- 1 Choose Direct.

Fn-esse displays the Add/Edit Command dialog box:

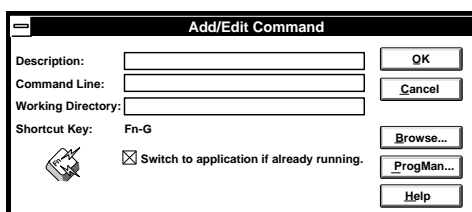

The Add/Edit Command dialog box

2 Choose Browse.

Fn-esse displays the Browse for Applications dialog box.

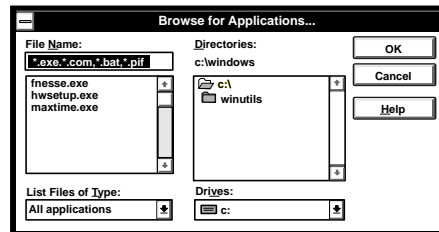

The Browse for Applications dialog box

3 Use the Drive and Directory fields to locate your file. You may narrow down your search with the List Files of Type list box.

4 In the File Name field, highlight the file you wish to assign to the key and choose OK.

Fn-esse displays the Add/Edit Command dialog box completely filled in to reflect your choice.

5 Choose OK to save your key assignment and exit the dialog box.

The program or document is now associated with the key you just selected. To open the program or document, press Fn plus the appropriate key from within any Windows program.

Using the ProgMan Browser Dialog Box

To use the ProgMan Browser dialog box to assign a key to a program or document, follow these steps:

- 1 Click the desired key in the Fn-esse keyboard with the secondary button.

Fn-esse displays the Assignment Type dialog box:

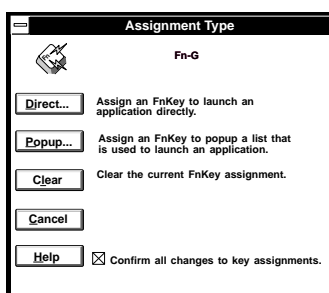

The Assignment Type dialog box

- 2 Choose Direct.

Fn-esse displays the Add/Edit Command dialog box:

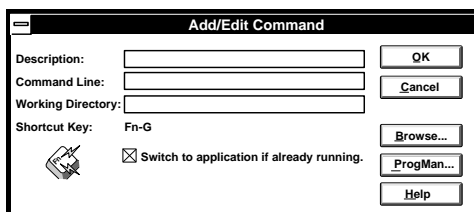

The Add/Edit Command dialog box

Using Online Documentation

Your Portégé 610CT computer comes equipped with this manual in the form of an electronic book, called online documentation. Cross-references in the text allow you to move through a series of related topics in the order you desire.

This section shows you how to:

- ❖ open the online documentation.
- ❖ select and read a topic.
- ❖ use the index.
- ❖ create and use bookmarks.
- ❖ cross-reference selected topics.
- ❖ search for selected information.
- ❖ get help with using the online documentation.
- ❖ reinstall online documentation.

Opening Online Documentation

To open online documentation, follow these steps:

- 1 Open Windows.**
- 2 Choose the Online Documentation icon in the Toshiba Utilities program group.**

Windows opens the online documentation program.

Reading a Selected Topic

The online manual is a “virtual” book, that looks and operates like a spiral-bound notebook referenced with index tabs. You can expand each section in the table of contents by clicking the file folder icon to the left of each chapter heading.

To read a section of a manual:

- ❖ To select a subsection, click its index tab or click Contents and select the section from the list displayed.
- ❖ To move to the beginning of the table of contents, click Contents.
- ❖ To move up or down in a section, click and drag the scroll box or click the up and down arrows at the right side of the screen.
- ❖ To move forward or backward one section at a time, click the left and right arrow icons at the bottom of the screen.

Using the Index

The online documentation program provides an alphabetical index for quick access to related topics. To use the index to select a topic:

1 Choose Index.

Online documentation displays the Index dialog box.

2 Select the topic you wish to read from the Index list and choose OK.

Online documentation displays the topic.

Using Bookmarks

Online documentation has a bookmark feature that allows you to switch quickly between marked sections. Bookmarks are saved for your future reference until you choose to delete them.

Define a User

Before you can create bookmarks, you must define a user (yourself). If more than one person will be using the online document, you should define a list of users. This allows each user to read the document with his or her own set of bookmarks.

To define a user, follow these steps:

1 Choose Define from the User menu.

Online documentation displays the Users dialog box.

2 Type the desired user name in the field and choose OK.

Creating a New Bookmark

To create (or define) a bookmark, follow these steps:

- 1 Choose Define from the Bookmark menu, or click the yellow bookmark icon in the lower-right corner of the screen.**

Online documentation displays the Define Bookmark dialog box. This dialog box automatically shows the current chapter in the Bookmark Name field as the default name, and displays a list of currently defined bookmarks.

- 2 Choose OK to accept the current chapter name as the bookmark.**

To change the default bookmark name, type the new name and choose OK.

If the name is already assigned to another bookmark, online documentation displays a message stating that the name already exists. Type the new bookmark name and choose OK.

Online documentation creates a consecutively numbered bookmark and places it in the online text. The bookmark appears at the upper edge of the online “book.”

To view a marked section, click its assigned bookmark. Online documentation switches to the corresponding text location.

Deleting a Bookmark

To delete a previously defined bookmark, follow these steps:

- 1 Choose Define from the Bookmark menu or click the yellow bookmark icon in the lower-right corner of the screen.**

Online documentation displays the Define Bookmark dialog box, which displays the list of currently defined bookmarks.

- 2 Select the bookmark name you wish to delete from the list.**
- 3 Choose delete.**

Online documentation deletes the bookmark.

- 4 Choose OK to close the Define Bookmark dialog box.**

Using Cross-References

Online documentation's cross-reference feature allows you to move quickly to sections containing information related to the material in your current section. For example, from the batteries section you can cross-reference to the MaxTime section.

Cross-references are shown in green underlined text.

To view a cross-reference, follow these steps:

1 Position the pointer over the cross-reference.

The pointer changes to a pointing hand icon.

2 Click on the cross-reference.

Online documentation displays the section containing the information relating to the cross-reference you selected.

When you have finished reading the cross-referenced material, clicking on Go Back returns you to the original topic.

Searching for a Topic

Online documentation has a full-text search feature that locates every topic that contains a word or phrase you are looking for. To use the full-text search feature, follow these steps:

1 Choose Search.

Online documentation displays the Search dialog box.

2 In the Search by Word field, type the word or phrase you would like to find.

You can substitute the last characters in a word with an asterisk (*) to find all the forms of the word. For example, typing bat*, would find "batch," "battery," "batteries," "battery-powered" and "battery-save."

3 Choose OK to start the search.

Online documentation displays the Search Results dialog box, displaying the list of topics containing the selected text.

4 Select the topic you wish to view and choose Go To.

Online documentation displays the topic with the word or phrase highlighted.

To exit the Search Results dialog box, choose Cancel.

To start a new search, choose To Search.

Getting Help

Choose Help Contents from the Help menu or press F1 to open online help. The help text explains the options available in the online documentation feature you're currently using.

Reinstalling Online Documentation

If for some reason you remove the online documentation from the hard disk, you'll need to restore it before you can use it again. To restore the online documentation to your hard disk, you must use the master program diskette that contains the online documentation files. For more information about master program diskettes, see "Create or Purchase Master Diskettes" on page 29.

Follow these steps to reinstall online documentation:

- 1 Insert the online documentation master program diskette in the diskette drive.**
- 2 Choose Run from the Program Manager File menu.**
- 3 Windows displays the Run dialog box:**

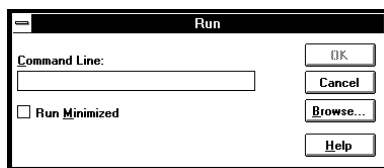

The Run dialog box

4 In the Command Line field, type a:\install and choose OK.

Follow the instructions on the screen to define the location of the files. If the directory you choose does not exist, the installation program creates it for you.

The installation program creates a program group, a program item and the online documentation icon.

5 When the installation is complete, eject the diskette from the drive.

What's Really Going On?

By now, you've probably become pretty good at using your computer. However, you may be curious as to what is really going on while you're pounding away at the keyboard. This chapter gives you all the details of how your computer works.

What Is a Computer?

In one sense, your Portégé 610CT is a computer. Technically speaking however, the processor chip, where the actual computing takes place, is the computer. Everything else either provides information to the processor or receives the results of the processor's computations.

What Other Batteries Does the Computer Have?

In addition to the main battery that powers your system when you're away from an AC outlet, your Portégé 610CT computer has two other batteries:

- ❖ The backup battery supports Resume Mode. When you turn the computer off in Resume Mode, a non-volatile memory powered by the backup battery keeps track of everything for the next time you turn the computer on. The backup battery gets its charge from the main battery.
- ❖ The RTC (real-time clock) battery maintains the computer's configuration information, which is stored in the RTC memory. When you make changes in TSETUP or Hardware Setup, this memory keeps track of those settings. The RTC battery also operates the computer's internal clock.
- ❖ The main battery charges the backup and RTC batteries.

How Does a Disk Store Information?

Like a tape recorder, a disk drive reads and writes magnetically encoded information on magnetic media. The drive positions a read/write head above the surface of the disk when it records and retrieves information.

Before a drive can read from or write to a disk, the disk must have a specific structure. Formatting a disk creates this structure.

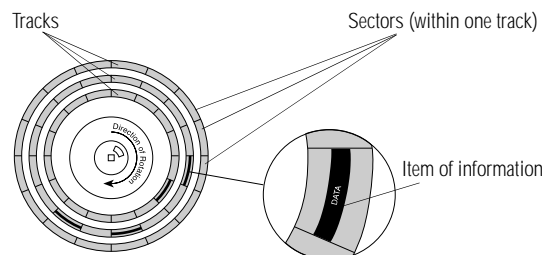

Tracks and sectors of a disk

Formatting divides each side of the disk into concentric circles called tracks. Each track is divided into sectors. Each item of information stored on a disk has a specific address composed of its side, track and sector number. This address makes it possible for the computer to locate the information on the disk.

How Big is a Megabyte, Anyway?

When you read about the size of your hard disk, you may be confused by the discrepancy between megabytes and millions of bytes. "Wait a minute," you say, "doesn't a megabyte equal one million bytes?" Well, not exactly...

Computers use base two arithmetic, also called binary arithmetic. Because of this, all numbers in computing are based on powers of two. One megabyte is actually equal to 1,048,576 bytes (2^{20}), the closest binary number to 1,000,000.

In the early days of personal computers, the difference was very minor because hard disks were small and computers didn't have much memory. As hard disk capacities and memory sizes have increased, the difference has become much more significant.

One hard disk that comes with the Portégé 610CT computer holds approximately 686.65 megabytes. You can convert this to millions of bytes by multiplying the number of megabytes (686.65) by the number of bytes in a megabyte (1,048,576). The result is 720,004,710, approximately 720 million bytes.

How Does the Screen Display Information?

Images on the Portégé 610CT computer's built-in liquid crystal display (LCD) are created by turning individual dots on the screen on or off in various combinations. These dots are called pixels.

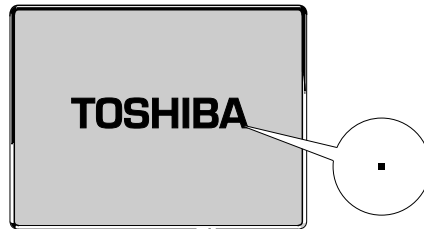

A pixel on the display

A pixel is the smallest element on the screen. On a color display, each pixel is made up of three subpixels: one red, one green and one blue (RGB). Each subpixel may be either on or off. Mixing on and off subpixels is like blending the primary colors to create other colors.

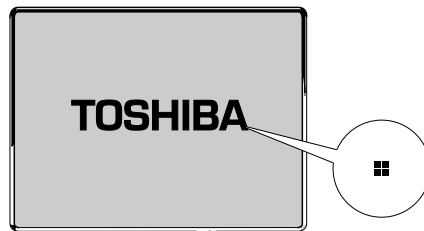

A pel formed by several pixels

The smallest element that your programs can control is called a pel. Pels are arranged on the screen in a grid-like fashion. Depending on the video mode a program selects, a pel may be a single pixel or several pixels.

The pel size determines the clarity of the image—called screen resolution. Larger individual pels reduce the total number of available pels, resulting in lower resolution. Smaller pels increase the number of pels that can fit on the screen, resulting in higher resolution and a clearer image.

Displaying Colors

The pel size also determines how many colors the display can produce. By combining pixels of different colors within a pel, the display can produce many more colors than are available within a single pixel. Therefore, larger individual pels increase the number of colors available to the display.

Video Modes

Video modes are sets of industry-standard rules about resolution and the maximum number of distinct colors that can be displayed simultaneously on the screen. Programs that adhere to the rules of a video mode will run on any system that supports that mode.

Most display adapters provide several video modes. The Portégé 610CT SVGA-compatible display adapter supports all VGA modes and some SVGA modes.

The video mode required by a program depends on:

- ❖ whether the program displays graphics or text.
- ❖ the resolution required for the text or graphics.
- ❖ the number of colors used.
- ❖ the font size (in pixels) of the text.

Based on these requirements, computers recognize two categories of video modes: graphics modes and text modes.

In a graphics mode, programs can turn on and off individual pels to display a variety of images. The computer controls every pel on the screen individually. This provides maximum display flexibility while somewhat reducing the speed at which the display produces images.

An image produced this way could be a drawing or picture, like a pie chart, graph or photograph. It could also be an icon or a variation on a text character, like italics or bold type.

Windows and Windows programs use graphics modes.

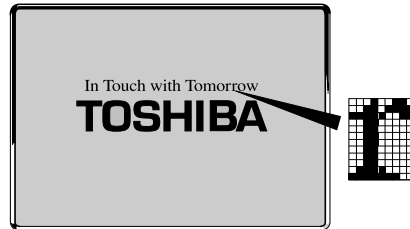

Character cell in a text mode

In a text mode, a character cell is the smallest element a program can control. A character cell is a grid of pels. All cells are the same size. Each cell displays a single letter or symbol. Character cells are arranged in rows and columns. In a text mode, only characters from a predefined set are available. If your program uses a text mode, refer to the program's documentation for a list of available characters.

What Is Plug and Play?

Plug and Play is a clever name for a new technology developed jointly by Intel and Microsoft that seeks to make upgrading a computer system easy.

Computer systems, such as the Portégé 610CT, operating software and add-on products that are designed according to this standard work together the first time you connect them. Plug and Play eliminates the time-consuming frustration of figuring out which IRQ and memory addresses to assign.

Since it's not possible to open a Portégé 610CT computer and add on devices, the fact that the system supports the Plug and Play standard is important for future software developments.

What Really Happens When You Turn the Computer On?

When you press the power button, the following occurs:

1 The computer's BIOS (Basic Input/Output System) loads a bootstrap program.

This program, named from the expression “pull yourself up by your bootstraps,” checks and displays the amount of memory in the system before proceeding.

2 The bootstrap program attempts to load MS-DOS.

It looks first for a diskette in the diskette drive and then at the hard disk. If a diskette without the necessary MS-DOS files is in the drive, the bootstrap program displays an error message.

3 As MS-DOS loads, it configures the system according to the contents of your CONFIG.SYS file.

4 MS-DOS carries out the commands in your AUTOEXEC.BAT file.

If you haven't changed the contents of the AUTOEXEC.BAT file, the last thing it does is load Windows.

If Something Goes Wrong

Some problems you may encounter when using the Portégé 610CT computer are relatively easy to identify and solve. Others may require help from your dealer or the manufacturer of a software program.

This chapter offers suggestions to help you track down the source of any problem and solve it. At the end of the chapter is a list of the addresses and telephone numbers for Toshiba services and support.

Develop Good Habits

We all know that an ounce of prevention is worth a pound of cure, but sometimes we're in such a hurry to use a computer that we fail to adequately prepare for the inevitable problems that will occur.

On a regular basis, back up the information stored on your hard disk. There are three ways you can do this:

- ❖ copy files to diskette in Windows using File Manager or the Microsoft Backup program

- ❖ copy files to diskette in MS-DOS using the BACKUP, COPY or XCOPY commands.
- ❖ connect a tape drive to the system and use specialized software to copy everything on the hard disk to a tape.

Some people use a combination of these methods, backing up all files to tape weekly and copying critical files to diskette on a daily basis.

If you've added your own software to your system, you should back up the software as well as the data. If something goes wrong that requires you to format your hard disk and start over, reloading all your software, as well as your data, from a backup will save time.

Diagnosing the Problem

The components used to manufacture computers are built to last for years. They rarely fail and when they do, don't panic: it's usually something simple.

Your first task is to define the problem by observing carefully what is happening. It's a good idea to stop what you're doing and jot down on a piece of paper what seems to be going wrong. This activity will suggest things you can try to further diagnose the problem.

Is it Hardware or Software?

The next thing to decide is if your problem is related to the software you're using or to the computer itself (the hardware). This may not be as easy as it sounds. Some software problems masquerade as hardware problems and vice versa.

The rules and tips in this section are designed to help you pursue all available clues until you have a good definition of what happens.

Pay Attention to the Little Things

If you've used your computer for a while, you know how it normally works.

- ❖ Is everything suddenly working slower than usual?
- ❖ Do you see any error messages or unusual characters on the screen? If so, what are they?
- ❖ Is there anything missing from the screen that you're used to seeing?
- ❖ Are any indicator lights on? If so, which ones?
- ❖ Do you hear any beeps? If so, how many? Are they long or short?

It helps if you can make the problem happen every time you try the same steps. A problem that can be reproduced can be solved. So, after you've read the next section, try to make the problem happen again.

Ten Things to Do to Keep Your Sanity

- ❖ If you're able to do so, save your work immediately.

If the system is locked (you can type or move the mouse, but nothing happens when you do so), you won't be able to save your work. In this case, you may have to start again from the last version of the file on disk or from your backup.

- ❖ Review what you just did.

Many problems occur because you made an error. Read the section in your software manual that deals with what you are currently doing and follow any suggestions that seem to apply.

- ❖ If your screen displays an error message, go to your software manual first.

If you can't find the error in your software manual, refer to your Windows and Toshiba MS-DOS manuals. If the error is not documented anywhere, write it down exactly as it appears on the screen.

210 **If Something Goes Wrong** *Ten Things to Do to Keep Your Sanity*

If you must call for help, you need to be able to tell the technician on the other end of the phone (who can't see your screen) exactly what the error message said.

- ❖ Make sure all cables are firmly attached.

Loose cables can cause unrelated error conditions and/or messages. For example, if you're using an external monitor and the monitor's data cable (connected to the computer's video adapter) comes loose, the colors on the monitor may seem to fade. You may think the monitor is the problem, but really it's just a loose cable.

- ❖ Make sure the battery has power or the computer is plugged into a live wall outlet.
- ❖ Call a friend who has experience with a similar configuration.

Almost all computer users have someone they can call to discuss such problems. If you don't know anyone to call, find an electronic information source such as Toshiba's Bulletin Board Service or CompuServe.

- ❖ If you've just installed a new program or a new device, the problem is probably related to that program or device.

You may need to reinstall the program or remove the device, make sure everything works correctly and then install the program or the device again using a different Interrupt Request level (IRQ), memory address, or other option.

- ❖ Read the manuals.

It's very difficult to provide a fail-safe set of steps you can follow every time you experience a problem with the computer. Your ability to solve problems will improve as you learn about how computers and software work together.

Read all the manuals provided with your computer, as well as the manuals that come with the programs and devices you purchase.

Your local computer store or book store contains a variety of self-help books you can use to supplement the information in this manual.

If you're one of those people for whom computers are an utter mystery, you're not alone! Don't hesitate to purchase an elementary computer book.

- ❖ Press Ctrl + Alt + Del.

If you're in Windows when you do this, you may get a message asking whether you really want to restart the system. For some problems, Windows may offer to close the offending program for you. Follow the instructions on the screen. If Windows closes the program for you, it's still a good idea to exit from Windows, restart the computer and start Windows again.

If the computer is in Resume Mode, you may have to press the reset button, located on the front of the computer.

- ❖ Take a break.

If you've been fighting to solve a problem for a long period of time, you're probably frustrated by now. Stand up and take a deep breath. Often, you can find a new solution to a problem just by stepping away from it for a few moments.

Software Tips

For the most part, this chapter discusses specific problems related to the computer itself. It does not cover software problems because there's no way Toshiba can know which programs you are using. This is why one of the steps in "Ten Things to Do to Keep Your Sanity" on page 209 involves searching your software manuals.

This section provides some general software tips.

Use Only Toshiba MS-DOS

Your computer comes with a version of MS-DOS that has been modified to support Toshiba's Resume Mode and other unique features unique to Toshiba notebook computers. Other versions of MS-DOS are available from your dealer.

If you install another version on your Portégé 610CT, you won't be able to use these Toshiba-specific features: Resume Mode, MaxTime, Hardware Setup and Fn-esse.

To upgrade your version of Toshiba MS-DOS, you'll need:

- ❖ the Toshiba Special Enhancements Diskette that came with your computer.
- ❖ an MS-DOS upgrade package (available at your computer store).
- ❖ a new Toshiba Special Enhancements Diskette. You can order this diskette directly from Toshiba.

Software and CPU Sleep Mode

If you've turned on (enabled) CPU sleep mode, and you open a program that immediately stops working (locks), turn off (disable) sleep mode and try to run the program again.

You disable sleep mode in MaxTime or TSETUP. Follow these steps to disable sleep mode using MaxTime:



- 1 Double-click the MaxTime icon to open or restore the program.**
- 2 Choose Machine Settings from the MaxTime Options menu.**

MaxTime displays the Machine Settings dialog box.

- 3 Click Battery Options.**

MaxTime displays the battery options.

- 4 Set the Battery Save Mode to User Settings.**
- 5 Choose Disabled for Sleep Mode.**

- 6 Choose OK or press Enter to save your changes and exit the dialog box.**
- 7 Minimize MaxTime or close the program by choosing Exit from the File menu. You don't have to restart the computer for this change to take effect.**

If the problem continues, contact the manufacturer of the program.

General Protection Faults and System Errors

If you encounter a General Protection Fault or System Error while using a Windows program, quit Windows and restart the computer before you continue. (Press the reset button if Resume Mode is enabled.)

A General Protection Fault is an indication that Windows has tried to assign two or more programs to the same area in memory. A System Error indicates a problem within one program. While a System Error is not as serious as a General Protection Fault, it's still a good idea to quit Windows and restart your computer before continuing to work.

Unlike a General Protection Fault, a System Error usually lets you save files, if you have other programs open. Make sure you save these files before you exit from Windows.

Follow these steps if you receive a General Protection Fault or a System Error:

- 1 Choose OK to close the error message dialog box.**
- 2 If you are able to do so, save open files in other programs and exit from Windows. If your computer does not respond, continue with step 3.**
- 3 Press Ctrl + Alt + Del to restart your computer. If this has no effect, press the reset button.**

When the computer starts and loads Windows again you may continue working.

Bad or improperly connected memory cards may also cause these errors. To correct this problem:

- 1 Make sure the computer isn't in Resume Mode.**
- 2 Turn the computer off.**
- 3 Referring to "Install the Memory Module" on page 17, remove the memory card.**
- 4 Reinstall the memory card, making sure it's seated properly.**
- 5 Replace the memory expansion slot cover.**
- 6 Check for the error again.**
- 7 If the error reoccurs, remove the memory card entirely and check for the error again.**

If removing the memory card eliminates the error, the memory card may be bad. If the error reoccurs without the memory card installed, the error is not caused by the memory card.

Solving Computer Problems

If you're sure your problem is not software related, you probably have a good idea which component is not working properly. The rest of this chapter explains possible solutions for various problems. The chapter discusses each system component in turn.

Turning the Computer On

When you turn the power on, the system loads what's called a bootstrap program stored in the computer's Basic Input/Output System (BIOS).

This program looks for a file called COMMAND.COM on a diskette in drive A. If there's no diskette in drive A, the bootstrap program looks for COMMAND.COM in the root directory of drive C. It is normal for drive A to be empty when you start the computer and for the system to read the COMMAND.COM file from drive C. You may change the order in which the bootstrap pro-

gram accesses the drives by changing the Boot Priority option in Hardware Setup or TSETUP.

These problems might appear when you turn the power on:

The computer won't start.

Make sure you attached the AC adapter properly or installed a charged battery. Press and hold the power button for a few seconds.

The computer seems to start correctly but, when you press a key on the keyboard or press the AccuPoint, nothing happens.

You are probably in Resume Mode and have a software or resource conflict. When this happens, turning the power on returns you to the problem instead of restarting the system. To clear the condition, press Ctrl + Alt + Del or press the reset button.

Clearing the condition may get you running by disabling Resume Mode, but it won't solve a resource conflict. Read the documentation that came with the conflicting device and "Resolving Resource Conflicts" on page 233.

The computer displays the Non-System disk or disk error message.

Does the diskette drive contain a diskette? If so, remove it and press any key to continue. If pressing any key does not work, press Ctrl + Alt + Del or press the reset button to restart the computer.

The computer displays the Bad or missing Command Interpreter message.

You've configured the computer to start from the hard disk and:

- ❖ you accidentally deleted the COMMAND.COM file, or
- ❖ the operating system can't find the COMMAND.COM file (it may be in a directory other than the root directory), or

- ❖ you copied an incompatible version of COMMAND.COM over the COMMAND.COM supplied with Toshiba MS-DOS, or
- ❖ the COMMAND.COM file is corrupt.

To put the correct COMMAND.COM file in the root directory of drive C, follow these steps:

1 Insert the installation diskette for your current version of MS-DOS into the diskette drive.

This is one of the master diskettes you created by running Master Disk Creator or purchased directly from Toshiba. If you do not have this diskette, refer to “Create or Purchase Master Diskettes” on page 29.

2 Press Ctrl + Alt + Del to restart the computer.

Toshiba MS-DOS displays a welcome screen.

3 Press F3.

Toshiba MS-DOS displays the EXITING Setup message.

4 Press F3 to display a system prompt.

5 When the Toshiba MS-DOS system prompt appears, type: copy a:command.com c:\ and press Enter.

6 Type: edit c:\autoexec.bat and press Enter.

7 Read the contents of your AUTOEXEC.BAT file carefully.

If this file contains a COMSPEC command, confirm that it identifies the correct location for COMMAND.COM (usually the C:\ directory). Refer to your Toshiba MS-DOS documentation for more information regarding the COMSPEC command.

8 Press Alt + F, then x to close EDIT and the AUTOEXEC.BAT file.

9 Type: edit c:\config.sys and press Enter.

- 10 If your CONFIG.SYS file contains a SHELL command, confirm that it identifies the correct location for COMMAND.COM (for example, shell=c:\command.com).**
- 11 Press Alt + F, then x to close EDIT and the CONFIG.SYS file.**
- 12 Remove the diskette from the drive.**
- 13 Press Ctrl + Alt + Del to restart the computer.**

Verifying the System

A system verification test confirms that all the components connected to the computer are working. This includes testing the memory, hard disk, diskette drive, etc. Use this test if you suspect a problem with any of these internal components.

Running the Test

To verify the system, follow these steps:

- 1 Turn the computer off.**
- 2 Hold the spacebar as you press the power button. If Resume Mode is on, hold the spacebar as you press the reset button.**

System verification displays the following message, which remains on the screen for a few seconds as the computer tests memory:

```
(C) Copyright 19>.xx Toshiba Corp. All rights reserved.  
MEMORY TEST .xxxKB
```

Successful Test Results

If the system verification test completes successfully, the computer sounds a short beep and attempts to open the operating system, first from drive A, then from drive C.

Unsuccessful Test Results

If the system verification test fails, the computer does one of the following:

- ❖ Stops updating the memory counter and does not proceed to display information or messages.
- ❖ Sounds a beep but displays no new messages.
- ❖ Displays random characters and does not function normally.
- ❖ Displays an error message.

Other Circumstances

The computer normally beeps at the conclusion of a successful system verification. If the system speaker is set to Disabled in MaxTime or TSETUP, this beep will not occur.

If the speaker is turned on (enabled) and the system verification completes but you don't hear a beep, the speaker may be faulty. Though this does not affect the computer's operation, you may wish to contact your dealer and have it repaired.

If the system verification completes successfully but the operating system won't load, refer to "Turning the Computer On" on page 214. If all seems correct, treat this as a hardware error and contact your dealer.

See if You Can Reproduce the Error

Verify the system again. Before you do so, turn the computer off and make sure all optional devices are connected properly. Then, run the test again. If the test fails a second time, you have demonstrated that you can reproduce the problem and it's time to contact your dealer.

Power and the Batteries

Your computer receives its power through the AC adapter or from the system batteries (main battery, real-time clock (RTC) battery and backup battery). Power problems are interrelated. For example, a bad AC adapter will neither power the computer nor recharge the batteries.

Here are some typical problems and how to solve them:

The power light doesn't come on when you plug in the AC adapter.

Make sure the AC adapter is firmly plugged into a working wall outlet.

The AC adapter works correctly, but the battery won't charge.

The main battery may not be inserted correctly in the computer. Turn off the computer, remove the battery and confirm that its contacts are clean. If they are dirty, clean the contacts with a soft, dry cloth and replace the battery.

The battery appears not to power the computer for as long as it usually does.

Check the power-saving features in MaxTime or TSETUP. Have you added a device? Is your software using the hard disk more? Is the display power set to turn off automatically? Is the battery fully charged to begin with? All these conditions affect how long the charge lasts.

For more information on maximizing battery power, refer to “Look After Your Battery” on page 100 and “Conserving Power” on page 95.

The Keyboard

If, when you type, strange things happen or nothing happens, the problem may or may not be related to the keyboard itself.

The keyboard produces unexpected characters.

A keypad overlay may be on. If the numeric keypad or cursor control light is on, press Fn + F10 to turn off the cursor control light or Fn + F11 to turn off the numeric keypad light.

Make sure the software you are using is not remapping the keyboard.

Nothing happens when you press the keys on the external keyboard.

Make sure the PS/2 keyboard is plugged into the PS/2 keyboard port and not the PS/2 mouse port on the Port Replicator.

You may have plugged the external PS/2 keyboard in while the computer was turned on. Press Ctrl + Alt + Del or press the reset button to restart the computer so it recognizes the device.

The keyboard locks and the computer will not restart.

Make sure the power is on and press the reset button.

The AccuPoint

Some of the keyboard conditions listed above may also affect the AccuPoint.

Your finger easily slides off the AccuPoint button.

The button may be oily. Clean it with a cotton swab dipped in rubbing alcohol.

The button may have become worn. Replace the button with one of the spares that came with your computer. Follow these steps:

1 Remove the AccuPoint button by grasping it firmly and pulling it straight up.

The AccuPoint spindle is now visible.

2 Position the new button on the spindle and press it into place.

The AccuPoint does not work after you restart the computer in Resume Mode.

The problem may be related to how your system is configured for power management.

Verify that the lines `DEVICEHIGH=C:\DOS\POWER.EXE` and `DEVICE=C:\DOS\EMM386.EXE` are in your `CONFIG.SYS` file. Refer to “Changing Your MS-DOS Startup Files” on page 186 for instructions on opening this file.

Check that the computer is set for MS-DOS System with Advanced Power Management in the Windows environment. To do this:

1 Exit Windows (do not use the DOS PROMPT in the Main program group).

2 At the system prompt, type `cd\windows` and press Enter.

3 Type `setup`.

The system displays the Windows Setup screen.

4 In the System Information section, check whether Computer: is set to “MS-DOS System with APM.” If it is, skip steps 5 through 10 and press Enter to return to the system prompt. To change the setting, continue with step 5.

5 Press the ↑ key until the Computer: field is highlighted.

6 Press Enter.

The system displays the Computer: options.

7 Use the ↓ and ↑ keys to highlight MS-DOS System with APM.

8 Press Enter.

9 Press Enter to accept the configuration.

10 Press Enter to keep the current driver.

You may be prompted to insert one or more Windows disks before returning to the system prompt.

The Display

Here are some typical display problems and their solutions:

The display is blank.

Display Auto Off may have gone into effect. Press any key to activate the LCD.

The display doesn't look right.

See "Changing the Display Mode" on page 183 to adjust your screen resolution or color settings.

The screen flickers.

Some flickering is a normal result of the way the screen produces colors. To reduce the amount of flickering, try using fewer colors.

The Disk Drives

Problems with the hard disk or with a diskette drive usually show up as an inability to access the disk or as sector errors. Sometimes a disk problem may cause one or more files to appear to have garbage in them. Typical disk problems are:

You are having trouble accessing a disk, or some of the data appears to be missing.

Make sure you're identifying the drive by its correct name (A or C).

Run the Toshiba MS-DOS SCANDISK command, which analyzes the directories, files and File Allocation Table (FAT) on the disk and repairs any damage it finds. You should not run SCANDISK from a Windows DOS session. Instead, exit from Windows first. For information on running SCANDISK, refer to your Toshiba MS-DOS documentation.

Your data files are damaged or corrupted.

Refer to your software documentation for file recovery procedures. Many software packages automatically create backup files.

You may also be able to recover lost data by using utility software, which is available from your dealer. (If File Manager or the DIR command doesn't display all the files stored in the directory, recovering data is unlikely.)

A diskette won't go into the external diskette drive.

You may already have a diskette in the drive. Make sure the drive is empty.

You may be inserting the diskette improperly. Hold the label of the diskette with the hub side facing down, and insert it so the metal head window cover goes into the drive first.

The metal cover or loose labels may be obstructing the path into the drive. Carefully inspect the diskette. If the metal cover is loose, replace the diskette. If the label is loose, replace the label and try inserting the diskette again.

The computer displays the Non-system disk or disk error message.

If you're starting the computer from the hard disk, make sure there's no diskette in the diskette drive.

A diskette won't format properly.

Check the FORMAT command options you're using. You can't format double-density diskettes as high-density diskettes and vice versa. Try using a different diskette. If the computer completes the formatting of the new diskette, run SCANDISK to check the diskette.

If the drive formats properly and SCANDISK doesn't report any errors during the test, the problem is probably a faulty diskette.

The drive can't read a diskette.

Try another diskette. If you can access the second diskette, the first diskette (not the disk drive) is probably causing the problem. Run SCANDISK on the faulty diskette.

If the problem occurs with each diskette you attempt to access, run the diagnostic test. Refer to "The Diagnostic Test" on page 289.

You cannot access a hard disk PC card.

MS-DOS keeps track of all drive letters in the system. Toshiba Card Manager determines the last MS-DOS drive letter and assigns the PC card slot to the next available letter(s).

This works as long as all drives in the system are MS-DOS drives. If, however, you are connected to a network or have a drive (such as a SCSI or CD-ROM drive) that uses drive letters not controlled by MS-DOS, the letter(s) assigned to the PC card slot may conflict with the non-MS-DOS drives.

You may be able to remap the non-MS-DOS drives. See the owner's manual that came with the drive.

Run PCMSETUP, the PC card configuration program and select Yes for AT drive support. Refer to your *Toshiba Card Manager* manual for more information.

Optional Devices

Optional devices can include a printer, PC cards, an external monitor, or any other device you connect to your computer to expand its capabilities. This section begins with some general comments and continues with sections for specific devices.

General Things to Look Out For

- ❖ Make sure you turn on the power to all optional devices before you turn the computer on.
- ❖ Check that all connecting cables are correctly and firmly attached. Loose cables can cause erroneous or intermittent signals. You may need to inspect connecting cables for loose wires, and check connectors for loose pins. On very rare occasions, the cable wiring may be faulty. Try a different cable or check the device's wiring requirements.

A Plan for Action

The smooth operation of the system depends on the interaction of all devices, programs and features. If the system or one of its attached devices isn't working, resolving the problem can be time consuming and frustrating.

The recommended procedure for getting multiple devices to work together is to add and configure one optional device at a time. After you add each device, test it to make sure it and all previously connected devices work.

These general steps help to remove the guess work and get all devices running as soon as possible:

- 1 Turn the computer off and remove the last device you added. If necessary, remove all devices.**
- 2 Turn the computer on and see if it works without the device(s) connected.**
- 3 If it does, add the next (or last) device.**
- 4 Add the device driver and any options to your configuration files.**



NOTE

Before you make any changes to your configuration files, make a copy of each file and assign it a different extension (for example, AUTOEXEC.OLD, CONFIG.OLD or WIN.OLD).

If your newly modified configuration file(s) cause the system to stop working, you can quickly return the computer to a working state.

To do so, delete the configuration file(s) you just modified and rename the.OLD file(s) with their usual extensions (for example, AUTOEXEC.BAT, CONFIG.SYS and WIN.INI respectively).

To determine what to add or change in your configuration files, refer to the documentation that came with the device.

To edit your configuration files from Windows, choose Run from the File menu, type sysedit and press Enter. The system editor displays all the configuration files.

5 Prepare the computer for the device by making any necessary changes using Hardware Setup in Windows or TSETUP in MS-DOS.

For information on using Hardware Setup and TSETUP, refer to “Hardware Setup” on page 261 and “TSETUP” on page 273, respectively.

6 Restart the computer for the changes to take effect.

7 If a conflict occurs, go back to the documentation for the device, “Resolving Resource Conflicts” on page 233, and the discussions of Hardware Setup (page 261) and TSETUP (page 273).

The problem is probably with the most recently connected device or its driver and configuration options.

Make sure there are no resource conflicts between the device you're adding and the other devices connected to the system.



A word to the wise: if you get too tired, take a break. You'll be surprised how different things will look when you've had a good night's sleep.

PC Cards

PC cards (PCMCIA-compatible) include many types of devices, such as a removable hard disk, additional memory, fax/modem or pager. The applications for these devices continue to grow as new products come onto the market almost daily.

Most PC card problems occur during installation and setup of new cards. If you're having trouble getting one or more of these devices to work together, several sections in this chapter may apply.

- ❖ Resource conflicts can cause problems when using PC cards. Refer to “Optional Devices” on page 224 and “Resolving Resource Conflicts” on page 233.
- ❖ If the device is a modem, see “Modems” on page 231.

Card Information Structure (CIS)

When you insert a PC card into a slot, the computer attempts to determine the type of card and resources it requires by reading its CIS. Sometimes the CIS contains enough information for you to use the card immediately. Other cards must be configured before you can use them.

Use Toshiba Card Manager to configure the card. The options you choose are stored in a file on your hard disk.

In addition, some card manufacturers use special software called enablers to support their cards. Enablers result in nonstandard configurations that can cause problems when installing another PC card.

Card and Socket Services Software

PC cards rely on Toshiba's Card Manager programs to provide the Card and Socket Services software the device driver needs. Make sure Card and Socket Services software is installed and configured correctly for your system.

Basic Things to Check

- ❖ Make sure the card is inserted properly into the slot.
Refer to “Little Cards that Do Big Things” on page 105 for how to insert PC cards, and to the documentation that came with the PC card.
- ❖ Make sure all cables are connected.

- ❖ Make sure the card installation software did not overwrite Toshiba Card Manager.
- ❖ Every once in a while a defective PC card slips through. If another PCMCIA-equipped computer is available, try the card in that machine. If the card malfunctions again, it may be defective.

Resolving Problems

Here are some common problems and their solutions:

The slots appear to be dead. Error messages appear while the computer processes the CONFIG.SYS file at system startup. Other PC cards that used to work no longer work.

If you installed the software that came with the PC card, the software may have overwritten the Toshiba Card Manager programs that came pre-installed on your system. Or the installation program may have added another manufacturer's version of Card and Socket Services to the system. Try running PCMSETUP again.

The computer stops working (hangs) when you insert a PC card.

The problem may be caused by an I/O (input/output) conflict between the card and another device in the system. Make sure each device has its own I/O base address.

The PC card socket should have its own I/O base address. Since all cards share the same socket, each card is not required to have its own address.

Hot swapping (removing one PC card and inserting another without turning the computer off) fails.

If you're using a SCSI PC card or other card that needs special drivers to be loaded when the computer starts, the card must be in the PC card socket when you start the computer. After that, you may remove and insert it without turning the computer off.

The system does not recognize your PC cards when you turn on the computer in Resume Mode and you're using Toshiba Card Manager.

The problem may be related to how your system is configured for power management.

Verify that the lines `DEVICEHIGH=C:\DOS\POWER.EXE` and `DEVICE=C:\DOS\EMM386.EXE` are in your `CONFIG.SYS` file. Refer to “Changing Your MS-DOS Startup Files” on page 186 for instructions on opening this file.

Check that the computer is set for MS-DOS System with Advanced Power Management in the Windows environment. To do this:

- 1 Exit Windows (do not use the DOS PROMPT in the Main program group).**
- 2 At the system prompt, type `cd\windows` and press `Enter`.**
- 3 Type `setup`.**

The system displays the Windows Setup screen.

- 4 In the System Information section, check whether Computer: is set to “MS-DOS System with APM.” If it is, skip steps 5 through 10 and press `Enter` to return to the system prompt. To change the setting, continue with step 5.**
- 5 Press the `↑` key until the Computer: field is highlighted.**
- 6 Press `Enter`.**

The system displays the Computer: options.

- 7 Use the `↓` and `↑` keys to highlight MS-DOS System with APM.**
- 8 Press `Enter`.**
- 9 Press `Enter` to accept the configuration.**
- 10 Press `Enter` to keep the current driver.**

You may be prompted to insert one or more Windows disks before returning to the system prompt.

The System Still Does Not Recognize Your PC Card.

This problem may be caused by a low backup battery.

Charge the backup battery by following these steps:

- 1 Make sure the computer isn't in Resume Mode.**
- 2 Turn the computer off.**
- 3 Connect the AC adapter and charge the battery to 100%.**
- 4 Turn the computer on and leave it on for 24 hours with the AC adapter connected.**

The problem may also be caused by a conflict with the additional memory in your system.

If you have an extra memory card installed, make sure the computer isn't in Resume Mode, turn the computer off, and remove the card.

Where to Go for More Information

Refer to the *Toshiba Card Manager* manual for procedures and for more information about resolving PC card problems.

Printers

This section lists some of the most common printer problems.

The printer doesn't print.

Make sure the printer cable is firmly attached to both the computer and the printer. Make sure you installed the proper printer drivers, as shown in "Setting Up Windows to Work with Your Printer" on page 60.

The printer doesn't print what I see on the screen.

Many programs display information on the screen differently than the way they print it. See if your program has a print preview mode. This mode lets you see your work exactly as it will print.

Modems

A modem, fax/modem or fax/voice/modem is a serial device. This section lists common modem problems.

The modem won't receive or transmit properly.

Make sure the RJ-11 cable (the one that goes from the modem to the telephone line) is firmly connected to the modem's RJ-11 jack and the telephone line socket.

Check the serial port setting to make sure the hardware and software are referring to the same COM port (in Card Manager for a PC card modem; in Hardware Setup or TSETUP if you're using an external modem).

Check the communications parameters (baud rate, parity, data length and stop bits) specified in the communications software. It should be configured to transmit at 300, 1200, 2400, 4800, 9600 or 14400 bps (bits per second).

Refer to the software documentation and modem manual for information on how to change these settings.

The modem is on, configured properly and still won't transmit or receive data.

Make sure the line has a dial tone. Connect a telephone handset to the line to check this.

The other system may be busy or off-line.

Memory

This section lists possible solutions to some common memory problems. It is organized based on the type of memory. If you're not sure which type of memory is giving you problems, read through the entire section.

Conventional Memory

If your program reports that there isn't enough memory for it to run, you may not have enough conventional memory available for that program. To determine the memory needs of the program and the availability of memory in your system, follow these steps:

1 Find out how much and what type of memory (conventional or extended) your program requires.

This information is in the manual that came with the program. You may need to install more memory. Toshiba offers 8MB, 16MB, and 32MB optional memory cards.

2 At the system prompt, type `mem` to run the MEM command and check how much conventional memory is left for your programs.

MEM reports the number of bytes available.

3 If this is not enough memory, you may need to remove (or load into upper memory) device drivers or memory-resident programs from the CONFIG.SYS or AUTOEXEC.BAT files.

See the MS-DOS documentation provided with your computer for information on loading drivers and programs into upper memory.

When you start the computer and it displays an error during the memory test, run the diagnostic test. Refer to “The Diagnostic Test” on page 289. If the system reports any errors, write them down and call your dealer.

Extended Memory

Extended memory requires an extended memory manager, such as HIMEM.SYS, in your CONFIG.SYS file. The MS-DOS and Windows user's guides explain extended memory and how to use HIMEM.SYS.

Memory Problems in Windows

If Windows displays a message that there is not enough memory to run a program, try closing one or more open applications. This may free up enough memory to successfully run your program.

You can monitor memory use in Windows by choosing About Program Manager from the Program Manager Help menu. Check the memory and resource usage figures periodically until you get a feel for what are normal levels for your computer. Then, if you have a memory problem, check the figures again to see if they have changed significantly. If the numbers are considerably lower than usual, try restarting Windows.

Resolving Resource Conflicts

Just as a business person needs a telephone and a computer to get a job done, so also the various components built into the computer and the components you add to the system need certain resources to accomplish a task. A device, such as a CD-ROM drive or a modem, needs a direct line to the computer's Central Processing Unit (CPU). It also needs room in the computer's memory to store information as it works.

The direct line to the CPU is called an Interrupt ReQuest (IRQ) level or channel. You'll hear both terms used by technical experts. They mean the same thing. The memory required by a device begins at a specific place or address in memory called the Direct Memory Address (DMA).

The devices that come pre-installed, including the hard disk, diskette drive, and ports, have preassigned IRQ levels and DMAs. If you connect a new device that uses an IRQ or DMA that conflicts with the preassigned settings, the system and/or the device won't work.

To resolve the problem, you must either change the setting of the device or change the setting of the conflicting component in the system. The preassigned settings for IRQs, DMAs and input/output port assignments are discussed in "System Resources" on page 315.

If Your Hard Disk Goes Blank. . .

Take a deep breath. Take another deep breath. Now look at the *Portégé 610CT Reconfiguration Guide* that came with your computer. This short guide provides information on how to reinstall all the programs that were pre-installed on your computer when you bought it. These programs include:

- ❖ Toshiba MS-DOS
- ❖ Microsoft Windows for Workgroups 3.11
- ❖ Toshiba programs such as MaxTime, Hardware Setup, and Fn-esse
- ❖ Any other programs that came bundled with your computer

To reinstall these programs, you need to have created or purchased master diskettes. If you do not have these diskettes, contact Toshiba Product Support for assistance.

In addition to reinstalling the pre-installed software, you need to reinstall any programs or work you had saved on the hard disk. Use your backup installation and data diskettes to recover these files.

If You Need Further Assistance

If you have followed the recommendations in this chapter and are still having problems, you may need additional technical assistance. This section contains the steps to take as you prepare to ask for help.

Before You Call

Since some problems may be related to the operating system or the program you're using, it's important to investigate other sources of assistance first. Try the following before contacting Toshiba:

- ❖ Review the troubleshooting information in your Toshiba MS-DOS and Windows documentation.

- ❖ If the problem occurs while you are running a program, consult the program's documentation for troubleshooting suggestions. Contact the software company's technical support group for their assistance.
- ❖ Consult the dealer from whom you purchased your computer and/or program. Your dealer is your best source for current information.

For the number of a Toshiba dealer near you in the United States, call 1-800-457-7777.

Contacting Toshiba

If you still need help and suspect that the problem is hardware related, or if you would like to learn more about a particular topic, Toshiba provides a variety of ways to receive help and to learn more.

Toshiba's Automated Fax Service

Toshiba's Automated Fax Service System (AUTOFAX) provides ready access to useful information about Toshiba computers and accessories. You may select the documents using your touch-tone telephone. Toshiba's AUTOFAX System will send the requested information to your fax machine. Follow these steps to activate the system:

- 1 Dial the Toshiba AUTOFAX System at (714) 583-3800.**
- 2 To have an index of available documents faxed to you, press 1.**
- 3 If you know the document number for the information you need, press 2.**
- 4 Follow the automated instructions provided by the system.**



NOTE

When entering the area code for your fax number, do not include the "1" prefix.

The AUTOFAX System automatically calls your fax number and sends the requested information. The process usually takes minutes, however, please allow up to 24 hours to receive the information due to varying load conditions.

If your fax machine telephone number is busy or otherwise unavailable, the system makes up to three attempts to complete a transaction.

Toshiba's Bulletin Board Service

Toshiba's Bulletin Board Service (BBS) is available 24-hours a day, and is free of charge to anyone with a PC and a modem.

The Toshiba BBS uses the following protocol:

Data Bits: 8
Parity: None
Stop Bits: 1

You may use the following telephone numbers:

714-837-4408
714-837-4409

The Toshiba Forum

Toshiba's Forum on CompuServe (CIS) is an international group of Toshiba PC enthusiasts that numbers thousands of users. To access the Toshiba Forum, type go Toshiba at any CIS prompt.

Toshiba Voice Contact

To aid Toshiba, make sure you have:

- ❖ The computer and any optional devices related to the problem.
- ❖ The MS-DOS diskettes, the Toshiba Companion Diskette, and the rest of the master diskettes. You created these using Master Disk Creator or purchased them directly from Toshiba.
- ❖ The name and version of the program involved in the problem along with its installation diskettes.

- ❖ The information about what you were doing when the problem occurred.
- ❖ The exact error messages and when they occurred.

In the United States, you can reach Toshiba PC Product Support at:

800-999-4273

From outside the United States, call Toshiba PC Product Support at:

714-859-4273

Toshiba's Worldwide Offices

For additional help, contact one of these Toshiba offices:

Belgium

Toshiba Information Systems
(Belgium) SA NV
Rue Colonel Bourg Straat 123-125
B-1140 Bruxelles
Belgium

Germany

Toshiba Informationssysteme
(Deutschland) GmbH
Hammfelddamm 8
41460 Neuss
Germany

France

Toshiba Systemes (France) S.A.
7, Rue Ampere; BP 131
F-92804 Puteaux Cedex
France

Elsewhere in Europe

Toshiba Europa (I.E.) GmbH
Hammfelddamm 8
41460 Neuss
Germany

Australia

Toshiba (Australia) Pty. Ltd.
84-92 Talavera Road
North Ryde N.S.W.
2113 Australia

Canada

Toshiba of Canada, Ltd.
Computer Systems Group
191 McNabb Street
Markham, Ontario
Canada L3R 8H2

Italy

Olidata S.p.A.
Via Cavalcavia n. 55
I-47023 Cesena (FO)
Italy

Netherlands

Toshiba Information Systems
Benelux B.V.
Rivium Boulevard 41
NL-2909 LK Capelle
a/d IJssel
Netherlands

Spain

Toshiba Information Systems
(Espana) S.A.
Parque Empresarial San Fernando
Edificio Europa, 1a Planta,
Escalera A
E-28831 Madrid
Spain

Singapore

Toshiba Information Systems
(Singapore) PTE. LTD.
152 Beach Road
#17-01/04 Gateway East
Singapore 0718
Singapore

United States

Toshiba America
Information Systems, Inc.
Computer Systems Division
9740 Irvine Blvd
P.O. Box 19724
Irvine, CA 92713-9724 U.S.A.

PART II

TECHNICAL REFERENCE

What's In Part II

This part documents the Toshiba utility programs that come with the Portégé 610CT. If you are using MaxTime, Hardware Setup or TSETUP and you encounter an option you don't understand, you'll find it listed and explained in this part of the manual.

If you're new to computers, you can skip this part until you need it. If you're an old hand with computers, you may find explanations for the options you're using more quickly in this part than in Part I.

The Hotkeys

Hotkeys are keys that, pressed in combination with the Fn key, turn system functions on and off. Hotkeys have a white legend on the front of the key indicating the option or feature the key controls.

Instant Password Security

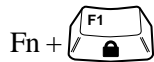

This hotkey locks the keyboard and blanks the display. You must enter your password, if registered, or press Enter to begin work again.

Power

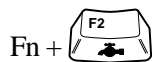

This hotkey switches among battery save modes.

Resume Mode

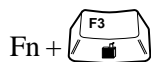

This hotkey turns Resume Mode on and off.

Sound

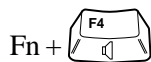

This hotkey cycles the alarm volume through off, low, medium and high. Off is always first.

Display

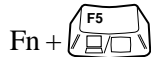

This hotkey alternates among the following display options: built-in display only, external monitor only and simultaneous display.

Keyboard

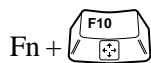

This hotkey turns the cursor control overlay on and off.

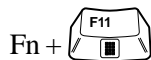

This hotkey turns the numeric overlay on and off.

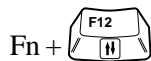

This hotkey turns the scroll lock feature on and off.

MaxTime®



MaxTime® opens automatically each time you start Windows. If MaxTime is not already open, double-click the MaxTime icon in the Toshiba Utilities program group.

Upon opening, MaxTime displays the MaxTime battery gauge.



The MaxTime battery gauge

The Display Dialog Box

To open the Display dialog box, choose Display from the Max-Time Options menu.

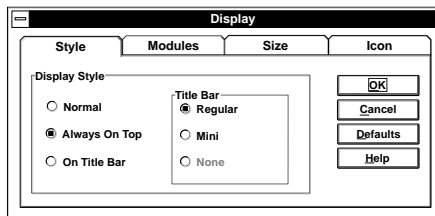

The Display dialog box

This dialog box controls the appearance of the MaxTime window. It provides four pages of display options, arranged like a stack of file folders. Each page of options has its own file folder tab.

To view or change these options, click the corresponding tab.

Buttons

The following table summarizes the buttons on the Display dialog box:

<i>Button</i>	<i>Function</i>
OK	saves current settings and exits the dialog box.
Cancel	ignores current settings and exits the dialog box.
Defaults	returns to the default settings.
Help	accesses online help.

The Style Page

This page controls the Display Style and Title Bar options.

The Display Style option controls where the MaxTime window appears on your screen. The available settings are:

<i>Settings</i>	<i>Description</i>
Normal (default)	allows the MaxTime window to be covered by other active windows.
Always On Top	keeps the MaxTime window on top of all other windows.
On Title Bar	places the MaxTime window on the title bar of the currently active window.

The Title Bar option controls the size of the MaxTime window's title bar. The available settings are:

<i>Settings</i>	<i>Description</i>
Regular (default)	displays the MaxTime title bar at full size.
Mini	reduces the size of the MaxTime title bar. This setting is only available when you have the Display Style option set to Normal or Always On Top.
None	hides the MaxTime title bar. This setting is only available when you have the Display Style option set to On Title Bar.

The Modules Page

This page controls how the battery gauge is displayed in the MaxTime window. The available modules are:



<i>Module</i>	<i>Description</i>
Bargraph (default)	displays the current battery charge as a horizontal bar graph.
Percent Remaining	displays the current battery charge as a percentage.

The Size Page

This page controls the size of the modules in the MaxTime window. The available settings are Small, Medium and Large.

The Icon Page

This page controls which icon MaxTime displays when running minimized. The available icons are:

<i>Settings</i>	<i>Graphic Displayed</i>	<i>Description</i>
Bargraph Module		displays the bar graph icon when MaxTime is running minimized.
Percent Remaining Module		displays the Percent Remaining icon when MaxTime is running minimized.
MaxTime Icon (default)		displays the MaxTime icon when MaxTime is running minimized.

The Alarms Dialog Box

To open the Alarms dialog box, choose Alarms from the Max-Time Options menu.

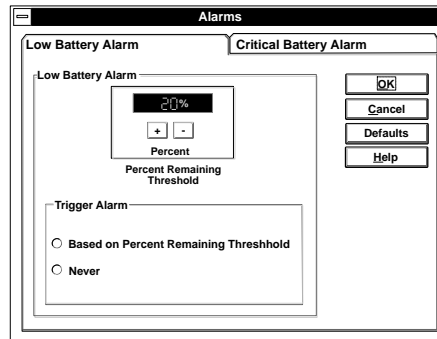

The Alarms dialog box

This dialog box displays the options for the Low Battery Alarm and the Critical Battery Alarm on two separate pages, arranged like a stack of file folders. Each page of options has its own file folder tab. The options for these alarms are identical.

To view or change these options, click the corresponding tab.

Buttons

The following table summarizes the buttons on the Alarms dialog box:

<i>Button</i>	<i>Function</i>
OK	saves current settings and exits the dialog box.
Cancel	ignores current settings and exits the dialog box.
Defaults	returns to the default settings.
Help	accesses online help.

Alarm Options

The following table summarizes the options you can set in the Alarms dialog box:

<i>Option</i>	<i>Settings</i>	<i>Usage</i>
Percent Remaining Threshold	xx% (where xx is a percentage you set)	allows you to set the trigger point for the battery alarm.
Trigger Alarm	Based on Percent Remaining Threshold	enables the battery alarm.
	Never	disables the battery alarm.

The Set Battery Charge Dialog Box

To open the Set Battery Charge dialog box, choose Set Battery Charge from the MaxTime Options menu. You may only choose this option when the battery charge is unknown to the system.

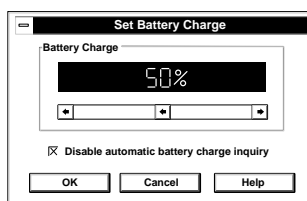

The Set Battery Charge dialog box

This dialog box allows you to estimate the battery charge.

Buttons

The following table summarizes the buttons on the Set Battery Charge dialog box:

<i>Button</i>	<i>Function</i>
OK	saves current settings and exits the dialog box.
Cancel	cancels current settings and exits the dialog box.
Help	accesses online help.

Battery Charge Options

The following table summarizes the battery charge options:

<i>Option</i>	<i>Settings</i>	<i>Usage</i>
Battery Charge	xx% (where xx is a percentage you set)	allows you to estimate the percentage of battery charge remaining.
Disable automatic battery charge inquiry	Enabled (check) Disabled (no check)	enables and disables the system's automatic battery charge inquiry.

The Machine Settings Dialog Box

To open the Machine Setting dialog box, choose Machine Settings from the MaxTime Options menu.

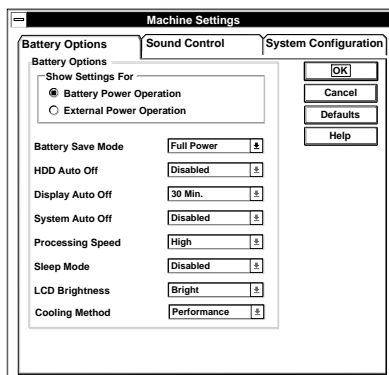

The Machine Settings dialog box

This dialog box controls the battery options, sound control options, and system configuration options. It provides three pages of options, arranged like a stack of file folders. Each page of options has its own file folder tab.

To view or change these options, click the corresponding tab.

The Battery Options Page

This page controls the battery options. The available options are:

<i>Option</i>	<i>Settings</i>	<i>Usage</i>
Show Settings For	Battery Power Operation External Power Operation	shows settings for use with battery power operation or external power operation.
Battery Save Mode	Full Power Low Power User Settings	allows you to select a preset battery save mode or customize the battery save options.

<i>Option</i>	<i>Settings</i>	<i>Usage</i>
HDD Auto Off	Disabled	turns the hard disk drive off if it is not used for the time set.
	1 Min.	
	3 Min.	
	5 Min.	
	10 Min.	
	15 Min.	
	20 Min.	
	30 Min.	
Display Auto Off	Disabled	turns the display off if it is not used for the time set.
	1 Min.	
	3 Min.	
	5 Min.	
	10 Min.	
	15 Min.	
	20 Min.	
	30 Min.	
System Auto Off	Disabled	turns the system off if you haven't used the computer for the time set.
	10 Min.	
	20 Min.	
	30 Min.	
	40 Min.	
	50 Min.	
	60 Min.	

<i>Option</i>	<i>Settings</i>	<i>Usage</i>
Processing Speed	Low High	sets the speed at which the Central Processing Unit (CPU) processes information.
Sleep Mode	Disabled Enabled	when enabled, temporarily shuts down the processor when there are no processing requests, such as keyboard input or pointing device movement.
LCD Brightness	Low High	sets the brightness of the display.
Cooling Method	Performance Quiet	sets the cooling method.

The Sound Control Page

This page sets the sound control options. The available options are:

<i>Option</i>	<i>Settings</i>	<i>Usage</i>
Speaker Volume	(user selectable)	sets the volume at which the speaker plays sounds. Choose the Test button to check the selected volume.

<i>Option</i>	<i>Settings</i>	<i>Usage</i>
Panel Close Alarm	Enabled (check) Disabled (no check)	enables and disables the alarm that sounds when you close the display panel while the computer is on.
Audible Low Battery Alarm	Enabled (check) Disabled (no check)	enables and disables the system's built-in audible battery alarm.
System Beep	Enabled (check) Disabled (no check)	enables and disables your software's use of the system speaker.

The System Configuration Page

This page controls the system configuration options. The available options are:

<i>Option</i>	<i>Settings</i>	<i>Usage</i>
Alarm Power On	hour:minute	sets the system to turn on at the time set (in AM, PM, or 24-hour format).
Disable Alarm Power On	Enabled (check) Disabled (no check)	when enabled, turns off the Alarm Power On Feature.
Resume Mode	Resume Mode (check) Boot Mode (no check)	turns Resume Mode on and off.

258 MaxTime® The Machine Settings Dialog Box

<i>Option</i>	<i>Settings</i>	<i>Usage</i>
Panel Power On/Off	Enabled (check) Disabled (no check)	turns the computer on/off when you open/close the computer's display panel. This option is only available when Resume Mode is selected.

Hardware Setup



To open Hardware Setup, double-click the Hardware Setup icon in the Toshiba Utilities program group.

Upon opening, Hardware Setup displays the following dialog box:

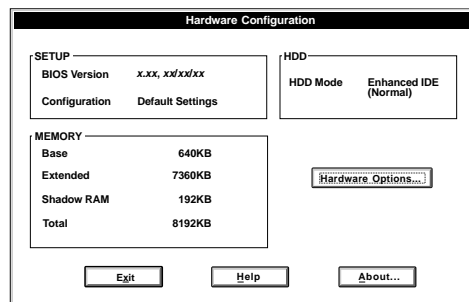

The Hardware Configuration dialog box

The Hardware Configuration Dialog Box

This dialog box displays system information. The values are calculated by the system and cannot be changed. It is for reference only.

Buttons

The following table summarizes the buttons on the Hardware Configuration dialog box:

<i>Button</i>	<i>Function</i>
Exit	exits the dialog box.
Help	accesses online help.
About	displays information about the Hardware Setup program.
Hardware Options	opens the Hardware Configuration Options dialog box.

The SETUP section

This section of the Hardware Configuration dialog box displays general information about the system:

<i>Information</i>	<i>Discussion</i>
BIOS Version	indicates the version and date of the computer's Basic Input/Output System (BIOS).

<i>Information</i>	<i>Discussion</i>
Configuration	indicates whether you're using the default configuration settings (Default Settings), or have changed any of the configuration settings (Custom Settings).

The MEMORY section

This section shows how the computer's memory is allocated. These values are calculated automatically by the system and cannot be changed.

<i>Memory Type</i>	<i>Description</i>
Base	displays the amount of conventional memory available to the computer.
Extended	displays the amount of extended memory available.
Shadow RAM	displays the amount of memory available for Shadow RAM. Shadow RAM copies (shadows) the computer's BIOS functions from ROM into faster RAM to improve system speed.
Total	displays the total amount of memory installed.

The HDD section

This section shows that the hard disk is set to Enhanced IDE mode. This is for your information only and cannot be changed.

The Hardware Configuration Options Dialog Box

To open this dialog box, choose Hardware Options in the Hardware Configuration dialog box.

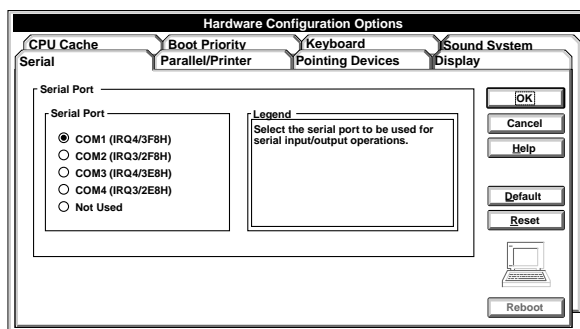

The Hardware Configuration Options dialog box

This dialog box controls the hardware configuration options. It provides seven pages of options, arranged like a stack of file folders. Each page of options has its own file folder tab.

To view or change these options, click the corresponding tab.

Restart Indicators

When you change an option that does not require the system to restart, Hardware Setup displays a small gray triangle to the left of the tab caption.

When you change an option that requires the system to restart, Hardware Setup displays a small lightning bolt icon to the left of the tab caption and in the computer screen at the lower right corner of the dialog box.

The Legend Field

Each page of hardware configuration options has a Legend field. This field displays information to help you choose option settings. For example, when you choose the Serial Port page, the Legend field displays the following message: "Select the serial port to be used for serial input/output operations."

Buttons

The following table summarizes the buttons on the Hardware Configuration Options dialog box:

<i>Button</i>	<i>Function</i>
OK	accepts your changes and exits the dialog box.
Cancel	ignores the changes you made and exits the dialog box.
Help	accesses online help.
Default	returns all options to their default settings. To make the defaults permanent, you must click OK.
Reset	returns all options to the settings in effect when you opened the dialog box.
Reboot	immediately restarts the computer. This button is available only if you change an option that requires a restart.

The Serial Page

This page controls the computer's serial port.

<i>Option</i>	<i>Settings</i>	<i>Usage</i>	<i>Restart</i>
Serial Port	COM1 (IRQ4/ 3F8H) (default) COM2 (IRQ3/ 2F8H) COM3 (IRQ4/ 3E8H) COM4 (IRQ3/ 2E8H) Not Used	sets the serial port name through which your communications software sends output to the serial port.	Y

The Parallel/Printer Page

This page controls the computer's parallel port.

<i>Option</i>	<i>Settings</i>	<i>Usage</i>	<i>Restart</i>
Parallel Port	LPT1 (378H) (default) LPT2 (278H) LPT3 (3BCH) Not Used	sets the parallel port name through which the computer communicates with the parallel port.	Y

<i>Option</i>	<i>Settings</i>	<i>Usage</i>	<i>Restart</i>
Printer Port Type	Output (default) Bi-directional	configures the parallel port to be used with a printer or other parallel device. Refer to the device's documentation to determine the setting it requires.	Y

The Pointing Devices Page

This page controls the pointing devices option.

<i>Option</i>	<i>Settings</i>	<i>Usage</i>	<i>Restart</i>
Pointing Devices	Auto-selected (default) Simultaneous (This option does not affect serial pointing devices.)	sets which pointing device is active when you connect an external PS/2 pointing device to the computer through the optional Port Replicator.	Y

The Display Page

This page contains the display options.

<i>Option</i>	<i>Settings</i>	<i>Usage</i>	<i>Restart</i>
LCD Display Colors	16 million colors	displays the number of colors available to the display.	N/A

<i>Option</i>	<i>Settings</i>	<i>Usage</i>	<i>Restart</i>
Power On Display	Internal/External (default) Simultaneous	controls whether the system sends output to the internal display, the external display or both when you turn the computer on.	Y
LCD Display Mode	Color (default) Monochrome	controls whether the computer displays images in color or in black and white.	Y
Text Mode Stretch	Enabled (default) Disabled	The screen has a height of 480 pixels. In a text mode, this leaves a small amount of space above and below the text on the screen. Enabling this mode stretches the text to fill the entire screen.	N

The CPU Cache Page

This page controls the CPU Cache option.

<i>Option</i>	<i>Settings</i>	<i>Usage</i>	<i>Restart</i>
CPU Cache	Enabled (default) Disabled	improves system performance when enabled. Disable this option only if your software requires you to do so.	Y

The Boot Priority Page

This page controls the Boot Priority option.

<i>Option</i>	<i>Settings</i>	<i>Usage</i>	<i>Restart</i>
Boot Priority	FDD→HDD (default) HDD→FDD	determines whether the system looks for the operating system first on the hard disk (HDD) or the diskette drive (FDD) when you turn the computer on.	N

The Keyboard Page

This page controls the keyboard options.

<i>Option</i>	<i>Settings</i>	<i>Usage</i>	<i>Restart</i>
External Keyboard Fn Key	Disabled (default) Left-Ctrl + Left-Alt Right-Ctrl + Right-Alt Left-Alt + Left-Shift Right-Alt + Right-Shift Left-Alt + CapsLock	allows you to use the selected key combination to emulate the computer's Fn key on an external keyboard.	N

<i>Option</i>	<i>Settings</i>	<i>Usage</i>	<i>Restart</i>
Int. Keyboard Key Layout	Normal (default) Alternative	selects the layout of the keyboard's CapsLock, Ctrl, and Alt keys.	Y

The Sound System Page

The page controls the sound system options.

<i>Option</i>	<i>Settings</i>	<i>Usage</i>	<i>Restart</i>
Sound System Enable	Enabled (check) (default) Disabled (uncheck)	enables the sound system. disables the sound system	Y
I/O Address	220h (default) 230h 240h 250h	lets you assign a unique Input/Output (I/O) address to the sound system.	Y
DMA Channel	Channel 0 Channel 1 (default) Channel 3	lets you assign a unique Direct Memory Address (DMA) channel to the sound system.	Y
Interrupt Level	IRQ5 IRQ7 IRQ9 IRQ10 (default)	allows you to assign a unique interrupt level to the sound system.	Y

TSETUP

To open TSETUP, follow these steps:

- 1 Close any programs you are running and exit Windows, if it's open.**



Run TSETUP outside of Windows, at a system prompt. If you try to run TSETUP from an MS-DOS session under Windows by clicking the MS-DOS Prompt icon, results can be unpredictable.

2 At the system prompt, type c:\dos\tsetup and press Enter.

TSETUP displays a screen similar to the following:

```

SYSTEM SETUP                                BIOS VERSION = X.XX
-----
MEMORY
Total      = 8192KB
Base       = 640KB
Extended   = 7360KB
Shadow BIOS ROM = 192KB

I/O PORTS
Serial Port = COM1 (IR04/3F8H)
Parallel Port = LPT1 (378H)
Sound System = Address/IRQ/DMA

DISPLAY
Display Adaptor = VGA Compatible
LCD Display Mode = Color

LCD Display Colors = 256K Colors
Power On Display = Internal/External
Text Mode Stretch = Enabled

PASSWORD
Not Registered

HARD DISK
HDD Mode = Enhanced IDE (Normal)

OTHERS
Power-up Mode = Boot
CPU Cache = Enabled
Battery Save Mode = Full Power
Alarm Volume = High
System Beep = Enabled
Panel Power On/Off = Disabled
Alarm Power On = Disabled
Keyboard = Layout/Fn
Pointing Devices = Auto-Selected
Boot Priority = FDD→HDD
Cooling Method = Performance

↑↓→:Select items Space, BkSp:Change Values
Esc:Exit without saving Home:Set default values End:Save changes and Exit
  
```

A sample System Setup screen

Making Changes in TSETUP

This table lists the keys to use in TSETUP.

<i>Key(s)</i>	<i>Result</i>
← and →	Moves between the two columns.
↑ and ↓	Moves between items in a column.
Spacebar and BkSp	Changes the selected item.
Esc	Quits TSETUP without saving changes.
End	Saves your changes and quits TSETUP, restarting the computer if necessary.
Home	Resets each option to its factory preset value.

Closing TSETUP

To close TSETUP and keep your changes, press End. When TSETUP asks you to confirm your action, press Y. TSETUP closes with your changes in effect and restarts the computer or returns you to the system prompt, depending on the changes you made.

To close TSETUP without saving your changes, press Esc. When TSETUP asks you to confirm your action, press Y. TSETUP returns you to the system prompt.

MEMORY

This group shows how the computer's memory is allocated.

<i>Memory Type</i>	<i>Description</i>
Total	displays the total amount of memory installed.
Base	displays the amount of conventional memory available to the computer.
Extended	displays the amount of extended memory available.
Shadow BIOS ROM	displays the amount of memory available for Shadow BIOS ROM. Shadow BIOS ROM copies (shadows) the computer's BIOS functions from ROM into faster RAM to improve system speed.

These values are calculated by the system and cannot be changed.

DISPLAY

This group configures the Liquid Crystal Display (LCD) and video port output.

<i>Option</i>	<i>Settings</i>	<i>Usage</i>	<i>Restart</i>
Display Adaptor	VGA Compatible (default)	automatically turns on the computer's internal display adapter. This setting cannot be changed.	N/A
LCD Display Mode	Color (default) Monochrome	controls whether the computer displays images in color or in black and white.	Y
Display Colors	16 M colors	displays the number of colors available to the display. It is set at 16 million colors and cannot be changed.	N/A
Power On Display	Internal/External (default) Simultaneous	controls whether the system sends output to the internal display, the external display or both when you turn the computer on in boot mode.	Y

<i>Option</i>	<i>Settings</i>	<i>Usage</i>	<i>Restart</i>
Text Mode Stretch	Enabled (default) Disabled	The screen has a height of 480 pixels. In a text mode, this leaves a small amount of space above and below the text on the screen. Enabling this mode stretches the text to fill the entire screen.	N

HARD DISK

This section shows the HDD Mode setting.

<i>Option</i>	<i>Settings</i>	<i>Usage</i>	<i>Restart</i>
HDD Mode	Enhanced IDE (Normal) Standard IDE	Choose Standard IDE only if you're working with an operating system, such as UNIX or Novell, that cannot handle the Enhanced IDE setting. Microsoft Windows and MS-DOS work with the Enhanced IDE setting.	Y

I/O PORTS

This group allows you to configure communications port settings for the serial and parallel ports.

<i>Option</i>	<i>Settings</i>	<i>Usage</i>	<i>Restart</i>
Serial Port	COM1 (IRQ4/ 3F8H) (default) COM2 (IRQ3/ 2F8H) COM3 (IRQ4/ 3E8H) COM4 (IRQ3/ 2E8H) Not Used	sets the serial port name through which your communications software sends output to the serial port.	Y
Parallel Port	LPT1 (378H) (default) LPT2 (278H) LPT3 (3BCH) Not Used	sets the parallel port name through which the computer communicates with the parallel port.	Y
Sound System	Address/IRQ/ DMA Disabled	lets you choose a unique I/O address, an Interrupt Request (IRQ) number, and a Direct Memory Address (DMA) channel for the sound system, or turn the sound system off.	Y

The following sound system options are in a drop -down list box that appears when you highlight Address/IRQ/DMA for the Sound System option:

<i>Option</i>	<i>Settings</i>	<i>Usage</i>	<i>Restart</i>
I/O Address	0220H 0230H 0240H 0250H	lets you assign a unique Input/Output (I/O) address to the sound system.	Y
Interrupt Level	IRQ5 IRQ7 IRQ9 IRQ10	allows you to assign a unique interrupt level to the sound system.	Y
DMA	Channel 0 Channel 1 Channel 3	lets you assign a unique Direct Memory Address (DMA) channel to the sound system.	Y

If you set the Parallel Port to anything other than Not Used, a drop-down list box appears offering a choice between Output and Bi-directional. Set this to Bi-directional only if the documentation for your parallel device instructs you to do so.

PASSWORD

This group lets you set or reset the system password.

<i>Settings</i>	<i>Restart</i>
Password	N
Not Registered (default)	

OTHERS

This group allows you to set many other configuration options. Whether or not you need to use these options depends primarily on the software and devices you use.

<i>Option</i>	<i>Settings</i>	<i>Usage</i>	<i>Restart</i>
Power-up Mode	Resume Boot (default)	alternates between Resume Mode and Boot Mode.	N

<i>Option</i>	<i>Settings</i>	<i>Usage</i>	<i>Restart</i>
CPU Cache	Enabled (default) Disabled	when enabled, improves system performance. Disable this option only if your software requires you to do so. If you set the CPU Cache to Enabled, a drop-down box lets you choose between Write-back (default) and Write-through. Write-back provides maximum performance. Write-through reduces performance to offer compatibility with older programs that may not run on a fast system.	Y
Battery Save Mode	Full Power (default) Low Power User Settings	allows you to select a pre-set battery save mode or customize the battery save options.	N
Alarm Volume	Off Low Medium High (default)	sets the volume at which the system's alarms beep (such as the low battery alarm). This also affects sounds generated by any PC card modem installed.	N
System Beep	Enabled (default) Disabled	enables and disables your software's use of the system speaker.	N

<i>Option</i>	<i>Settings</i>	<i>Usage</i>	<i>Restart</i>
Panel Power On/Off	Enabled Disabled (default)	turns the computer on/off when you open/close the computer's display panel. This option is only available when Resume Mode is selected.	N
Alarm Power On	xx:xx:xx (hour:minute: second) Disabled (default)	turns the computer on at the time set.	N
Layout/Fn		when you highlight this option, TSETUP displays a drop-down box listing the Keyboard options: Int. Keyboard Key Layout and Ext. Keyboard "Fn" key equivalent.	
Int. Keyboard Key Layout	Normal (default) Alternative	selects the layout of the keyboard's CapsLock, Ctrl, and Alt keys.	Y

<i>Option</i>	<i>Settings</i>	<i>Usage</i>	<i>Restart</i>
Ext. Keyboard “Fn” key equivalent	Disabled (default) Left Ctrl + Left Alt Right Ctrl + Right Alt Left Alt + Left Shift Right Alt + Right Shift Left Alt + Caps Lock	allows you to use the selected key combination to emulate the computer's Fn key on an external keyboard.	N
Pointing Device	Auto-selected (default) Simultaneous (This option does not affect serial pointing devices.)	sets which pointing device is active when you con- nect an external PS/2 pointing device to the computer through the optional Port Replicator.	Y
Boot Priority	FDD→HDD (default) HDD→FDD	determines whether the system looks for the oper- ating system first on the hard disk (HDD) or the diskette drive (FDD) when you turn the com- puter on.	N

The following battery save options appear in a drop-down list box when you highlight Battery Save Mode. You can change the settings in this box only if the Battery Save Mode is set to User Settings:

<i>Option</i>	<i>Settings</i>	<i>Usage</i>	<i>Restart</i>
Processing Speed	High (default)	sets the speed at which the Central Processing Unit (CPU) processes information.	N
	Low		
CPU Sleep Mode	Enabled	when enabled, temporarily shuts down the processor when there are no processing requests, such as keyboard input or pointing device movement.	N
	Disabled (default)		
Display Auto Off	01 Min.	turns the display off if it is not used for the time set.	N
	03 Min.		
	05 Min.		
	10 Min.		
	15 Min.		
	20 Min.		
	30 Min. (default)		
	Disabled		

<i>Option</i>	<i>Settings</i>	<i>Usage</i>	<i>Restart</i>
HDD Auto Off	01 Min.	turns the hard disk drive off if it is not used for the time set.	N
	03 Min.		
	05 Min.		
	10 Min.		
	15 Min.		
	20 Min.		
	30 Min.		
	Disabled (default)		
System Auto Off	10 Min.	turns the system off if you haven't used the computer for the time set. This option is available only if Resume Mode is on.	N
	20 Min.		
	30 Min.		
	40 Min.		
	50 Min.		
	60 Min.		
	Disabled		
LCD Brightness	Bright (default)	sets the brightness of the display.	N
	Semi-Bright		
Cooling Method	Performance (default)	sets the cooling method.	N
	Quiet		

The following sound options are in a drop-down list box that appears when you select Low, Medium, or High for Alarm Volume:

<i>Option</i>	<i>Settings</i>	<i>Usage</i>	<i>Restart</i>
Low Battery Alarm	Enabled (default)	enables and disables the system's built-in audible battery alarm.	N
	Disabled		
Panel Close Alarm	Enabled (default)	enables and disables the alarm that sounds when you close the display panel while the computer is on.	N
	Disabled		

The Diagnostic Test

This chapter explains how to use the diagnostic test program TDIAGS.EXE to determine if your system components are working properly.

Use the diagnostic test if you have a problem you could not identify with the tips listed in the chapter “If Something Goes Wrong.” The test verifies that the following system components (hardware) are in working order:

- ❖ system (the computer's internal hardware)
- ❖ memory
- ❖ video
- ❖ diskette drive
- ❖ hard disk drive
- ❖ printer (if you have one attached)

This chapter explains each of these tests in detail.

Starting the Diagnostic Test

To test hardware, it's important to start the diagnostic test without optional features or programs (for example, without memory-resident programs). To do so, you should run TDIAGS from the Toshiba Companion Diskette using the Toshiba Companion Utility (even though the TDIAGS program is on the hard disk).

Before you start the test, check all cables for loose connections. If any errors occur during the test, check all cable connections again.

To start the test, follow these steps:

- 1 Make sure the external diskette drive is connected.**
- 2 Put the Toshiba Companion Diskette in the diskette drive and press Ctrl + Alt + Del.**

After a moment, the computer displays a Welcome screen.

- 3 Press Enter.**

The Toshiba Companion Utility loads the diagnostic test and displays its main menu:

Main Menu

Install Utilities and Files
View README Documents
Setup Your Computer
Run Diagnostics
Run Master Diskette Creator
Exit to DOS

- 4 Use the arrow keys to select Run Diagnostics and press Enter.**

TDIAGS asks you to confirm that you want to run the diagnostic test.

- 5 To run the diagnostic test, press Y (for yes), and press Enter.**

The following sections explain the diagnostic test options.

Choosing Test Options

Before the test begins, the program asks several questions about which components you wish to test.

1 The first question asks if you want to test the diskette drive(s). The computer displays:

Test the FDD (Y/N)?

2 To test the diskette drive(s), type Y and press Enter. To bypass the test, type N and press Enter.

The FDD (floppy disk drive) test checks the internal diskette drive, and the external drive if you have one. Attach the external drive before running this test.



The test writes test patterns on any disk in the drive. These patterns destroy all information on the disk(s). Make sure there is no information you want to keep on the disk(s) you use.

If you choose the FDD test, you must format and write enable these disks before the test. For 3 1/2" disks, move the write-protect tab to cover the square hole.

The next prompt asks if you want to test the hard disk drive:

Test the HDD (Y/N)?

3 To test the hard disk, type Y and press Enter. Otherwise, type N and press Enter.



The hard disk test overwrites a portion of the information stored on the disk. Back up any important files before you test the hard disk.

The following prompt appears:

Test the printer (Y/N)?

- 4 Type Y to test the printer, or N to skip the test, and press Enter.**

Before beginning the test, make sure the printer is connected to the computer, the power is turned on, and the printer is on line.

If you chose to test the printer, the prompt displays:

Compatible with IBM printer (Y/N)?

- 5 To test an IBM or an IBM-compatible printer, type Y and press Enter. To test a non-IBM-compatible printer, type N and press Enter.**

If you choose an IBM printer when your printer is not an IBM or IBM-compatible printer, the test output will be unintelligible and may cause the printer to eject multiple blank pages. If you're not sure about your printer's compatibility, type N for a non-IBM-compatible printer.

Test Sequence

The diagnostic test checks the computer's components and printer in a predefined sequence as follows:

- 1 system test**
- 2 memory test**
- 3 display test**
- 4 FDD (floppy disk drive or internal diskette drive) test**
- 5 HDD (hard disk drive) test**
- 6 printer test**

While a test is in progress, the program displays:

```
IN PROGRESS TSSDSS
```

where *T* indicates the test number, the first *SS* indicates the subtest number, *D* indicates the drive (if tested), and the second *SS* indicates the hardware status. This message may remain on the screen for a moment. The following sections describe each subtest.

System Functions and Memory

The system functions and the memory tests run together for approximately two seconds. The system functions test doesn't display any messages. The memory test displays the following message:

PROGRESS xxxxxx

where xxxxxx is the current memory location being tested. The memory test includes conventional and extended memory.

If either test aborts:

- 1 Write down everything that appears on the screen.**
- 2 Press Ctrl + Pause to return to the diagnostics menu.**
- 3 Consult your dealer.**

Character Attributes

When the memory test completes, the diagnostic test displays the following screen:

```
CHARACTER ATTRIBUTES
NEXT LINE SHOWS NORMAL DISPLAY.
NNNNNNNNNNNNNNNNNNNNNNNNNNNNNNNNNN
NEXT LINE SHOWS INTENSIFIED DISPLAY.
IIIIIIIIIIIIIIIIIIIIIIIIIIIIIIIIII
NEXT LINE SHOWS REVERSE DISPLAY.
RRRRRRRRRRRRRRRRRRRRRRRRRRRRRRRRR
NEXT LINE SHOWS BLINKING DISPLAY.
BBBBBBBBBBBBBBBBBBBBBBBBBBBBBBBBB
```

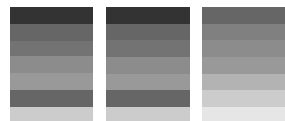
	BLUE RED MAGENTA GREEN CYAN YELLOW WHITE
---	--

Press [Enter] key

Character attributes test screen

Look under the message NEXT LINE SHOWS BLINKING DISPLAY to make sure the line is actually blinking.

The second test checks that the screen can display characters in an 80 column by 25 row format. The display should look like the following:

```
80*25 CHARACTER DISPLAY
01234567890123456789012345678901234567890123456789012345678901234567890123456789
! 3& ' ( ) * + , - . / 0 1 2 3 4 5 6 7 8 9 ; : <=> ? @ A B C D E F G H I J K L M N O P Q R S T U V W X Y Z [ \ ] ^ _ ` a b c d e f g h i j k l m n o
! 3& ' ( ) * + , - . / 0 1 2 3 4 5 6 7 8 9 ; : <=> ? @ A B C D E F G H I J K L M N O P Q R S T U V W X Y Z [ \ ] ^ _ ` a b c d e f g h i j k l m n o p
! 3& ' ( ) * + , - . / 0 1 2 3 4 5 6 7 8 9 ; : <=> ? @ A B C D E F G H I J K L M N O P Q R S T U V W X Y Z [ \ ] ^ _ ` a b c d e f g h i j k l m n o p q
! 3& ' ( ) * + , - . / 0 1 2 3 4 5 6 7 8 9 ; : <=> ? @ A B C D E F G H I J K L M N O P Q R S T U V W X Y Z [ \ ] ^ _ ` a b c d e f g h i j k l m n o p q r
! 3& ' ( ) * + , - . / 0 1 2 3 4 5 6 7 8 9 ; : <=> ? @ A B C D E F G H I J K L M N O P Q R S T U V W X Y Z [ \ ] ^ _ ` a b c d e f g h i j k l m n o p q r s
! 3& ' ( ) * + , - . / 0 1 2 3 4 5 6 7 8 9 ; : <=> ? @ A B C D E F G H I J K L M N O P Q R S T U V W X Y Z [ \ ] ^ _ ` a b c d e f g h i j k l m n o p q r s t
! 3& ' ( ) * + , - . / 0 1 2 3 4 5 6 7 8 9 ; : <=> ? @ A B C D E F G H I J K L M N O P Q R S T U V W X Y Z [ \ ] ^ _ ` a b c d e f g h i j k l m n o p q r s t u
! 3& ' ( ) * + , - . / 0 1 2 3 4 5 6 7 8 9 ; : <=> ? @ A B C D E F G H I J K L M N O P Q R S T U V W X Y Z [ \ ] ^ _ ` a b c d e f g h i j k l m n o p q r s t u v
! 3& ' ( ) * + , - . / 0 1 2 3 4 5 6 7 8 9 ; : <=> ? @ A B C D E F G H I J K L M N O P Q R S T U V W X Y Z [ \ ] ^ _ ` a b c d e f g h i j k l m n o p q r s t u v w
! 3& ' ( ) * + , - . / 0 1 2 3 4 5 6 7 8 9 ; : <=> ? @ A B C D E F G H I J K L M N O P Q R S T U V W X Y Z [ \ ] ^ _ ` a b c d e f g h i j k l m n o p q r s t u v w x
! 3& ' ( ) * + , - . / 0 1 2 3 4 5 6 7 8 9 ; : <=> ? @ A B C D E F G H I J K L M N O P Q R S T U V W X Y Z [ \ ] ^ _ ` a b c d e f g h i j k l m n o p q r s t u v w x y
! 3& ' ( ) * + , - . / 0 1 2 3 4 5 6 7 8 9 ; : <=> ? @ A B C D E F G H I J K L M N O P Q R S T U V W X Y Z [ \ ] ^ _ ` a b c d e f g h i j k l m n o p q r s t u v w x y z
! 3& ' ( ) * + , - . / 0 1 2 3 4 5 6 7 8 9 ; : <=> ? @ A B C D E F G H I J K L M N O P Q R S T U V W X Y Z [ \ ] ^ _ ` a b c d e f g h i j k l m n o p q r s t u v w x y z {
! 3& ' ( ) * + , - . / 0 1 2 3 4 5 6 7 8 9 ; : <=> ? @ A B C D E F G H I J K L M N O P Q R S T U V W X Y Z [ \ ] ^ _ ` a b c d e f g h i j k l m n o p q r s t u v w x y z { }
! 3& ' ( ) * + , - . / 0 1 2 3 4 5 6 7 8 9 ; : <=> ? @ A B C D E F G H I J K L M N O P Q R S T U V W X Y Z [ \ ] ^ _ ` a b c d e f g h i j k l m n o p q r s t u v w x y z { } -DCU
! 3& ' ( ) * + , - . / 0 1 2 3 4 5 6 7 8 9 ; : <=> ? @ A B C D E F G H I J K L M N O P Q R S T U V W X Y Z [ \ ] ^ _ ` a b c d e f g h i j k l m n o p q r s t u v w x y z { } -DCU6
! 3& ' ( ) * + , - . / 0 1 2 3 4 5 6 7 8 9 ; : <=> ? @ A B C D E F G H I J K L M N O P Q R S T U V W X Y Z [ \ ] ^ _ ` a b c d e f g h i j k l m n o p q r s t u v w x y z { } -DCU64
PRESS [ENTER] KEY.
```

Second character set test screen

If the screen matches this illustration, continue with the tests by pressing Enter. If your screen doesn't match the diagnostic test display, write down the differences and contact your dealer.

Graphics Capabilities

The next subtests check the screen's graphics capabilities for each of the computer's graphics modes.

During the test, the resolution and mode number appear above an image representing the mode's capabilities. The number inside the brackets is the mode number.

The illustration below shows the test image for one of the 320 x 200 graphics modes (mode 4).

320*200 GRAPHICS DISPLAY : [4]



PRESS [ENTER] KEY

Graphics capabilities test screen

A similar screen appears for each of the computer's graphics modes.

Press Enter to proceed with the next screens. Each screen has a similar image (three boxes of different shades of gray), differing primarily in resolution. If a different image appears on your screen, contact your dealer. If the screens match the display, press Enter to go to the next test.

Diskette Drives

If you selected the diskette drive test, you see a prompt that asks you to insert a disk into each drive you want to test.

Insert a formatted, write-enabled diskette into each drive.



This test may destroy all information on the diskettes. Make sure there is no information you want to keep on the diskettes you use.

To skip this test and return to the diagnostics menu, press Ctrl + Pause.

After you insert the diskette(s) in the drive(s), press Enter. The test begins and displays this message:

FLOPPY DISK IN PROGRESS 503000

If an error occurs, the test displays the ABORTED message. Write down the highlighted numbers and return to the main menu by pressing Ctrl + Pause.

If a diskette drive fails the test, check the following:

- ❖ Does the drive contain a diskette?
- ❖ Is the diskette properly formatted?
- ❖ Is the diskette write-enabled?
- ❖ Is the diskette undamaged?

Repeat the test with another diskette. If the test displays the ABORTED message again, see your dealer. If you inserted a write-protected diskette or if you left the drive empty, the test aborts. Return to the main menu by pressing Ctrl + Pause.

If the test completes successfully, and you selected the hard disk test, the diagnostic test begins checking the hard disk. If you did not select the hard disk or printer test, the diskette drive test concludes by displaying the TDIAGS screen. To exit TDIAGS, go to “Exiting the Diagnostic Menus” on page 299.

Hard Disk

If the diskette drive(s) tests successfully and you selected the hard disk drive test, the hard disk test displays this message:

HARD DISK TEST IN PROGRESS 805100

If an error occurs, the test displays the **ABORTED** message. Write down all messages and highlighted numbers and consult your dealer. Your computer or your drive may need service. To return to the main menu, press Enter.



The hard disk test does not destroy all of the information stored on the hard disk. However, this test overwrites a small portion of the disk. Back up any important files before you test the hard disk.

If the test completes successfully, and you selected the printer test, the diagnostic test begins the printer test. If you did not select the printer test, the hard disk test concludes by displaying the TDI-AGS screen. To exit TDIAGS, go to “Exiting the Diagnostic Menus” on page 299.

Printer

If the hard disk drive tests successfully and you selected to test the printer, the printer test displays this message:

PRINTER TEST IN PROGRESS 60xxxx

where *xxxx* is a counter that shows the test is still in progress. If you specified an IBM-compatible printer, the test sends the following output to the printer:

```
PRINTER TEST
1. THIS LINE SHOWS NORMAL PRINT.
2. THIS LINE SHOWS DOUBLE WIDTH PRINT.
3. THIS LINE SHOWS GROSSED PRINT.
4. THIS LINE SHOWS EMPHASIZED PRINT.
5. THIS LINE SHOWS DOUBLE STRIKE PRINT.
6. ALL CHARACTERS PRINT

!#$%&'()*+,-./0123456789:;<=>?@ABCDEFGHIJKLMNQRSTUvwxyz[\]^-_`abodefghi.jklmn
opqrsuvwxyz{|}~
```

IBM-compatible printer output

If you specified a non-IBM-compatible printer, the test sends the following output to the printer:

```
!#%&'()*+,-./0123456789:;<=>?@ABCDEFGHIJKLMNQRSTUvwxyz{|}_~"abcde fghi jklmno
!#%&'()*+,-./0123456789:;<=>?@ABCDEFGHIJKLMNQRSTUvwxyz{|}_~"abcde fghi jklmnop
!#%&'()*+,-./0123456789:;<=>?@ABCDEFGHIJKLMNQRSTUvwxyz{|}_~"abcde fghi jklmnopq
!#%&'()*+,-./0123456789:;<=>?@ABCDEFGHIJKLMNQRSTUvwxyz{|}_~"abcde fghi jklmnopqr
!#%&'()*+,-./0123456789:;<=>?@ABCDEFGHIJKLMNQRSTUvwxyz{|}_~"abcde fghi jklmnopqrs
!#%&'()*+,-./0123456789:;<=>?@ABCDEFGHIJKLMNQRSTUvwxyz{|}_~"abcde fghi jklmnopqrst
!#%&'()*+,-./0123456789:;<=>?@ABCDEFGHIJKLMNQRSTUvwxyz{|}_~"abcde fghi jklmnopqrstu
!#%&'()*+,-./0123456789:;<=>?@ABCDEFGHIJKLMNQRSTUvwxyz{|}_~"abcde fghi jklmnopqrstu
!#%&'()*+,-./0123456789:;<=>?@ABCDEFGHIJKLMNQRSTUvwxyz{|}_~"abcde fghi jklmnopqrstu
!#%&'()*+,-./0123456789:;<=>?@ABCDEFGHIJKLMNQRSTUvwxyz{|}_~"abcde fghi jklmnopqrstu
!#%&'()*+,-./0123456789:;<=>?@ABCDEFGHIJKLMNQRSTUvwxyz{|}_~"abcde fghi jklmnopqrstu
```

Non-IBM-compatible printer output

If an error occurs, the test displays the ABORTED message. Write down all messages and highlighted numbers and check the following items:

- ❖ Is the printer power cord securely plugged into a live wall outlet?
- ❖ Is the printer cable properly connected to the computer?
- ❖ Is the printer turned on?
- ❖ Is the printer ready (on line or selected)?

Repeat the test. If the test displays the ABORTED message again, or your printout doesn't match the output shown in the illustrations, consult your dealer to have the printer and the cable serviced.

If the printer tests successfully, the test displays the COMPLETED message. Press Enter to return to the TDIAGS screen. To exit TDIAGS, continue with the next section.

Exiting the Diagnostic Menus

To exit the diagnostic menu, follow these steps:

- 1 When TDIAGS completes system components testing, type N and press Enter.**
TDIAGS returns you to the Main menu.
- 2 Remove the Toshiba Companion Diskette from the diskette drive and press Ctrl + Alt + Del or the reset button to restart the computer.**

The computer restarts.

PART III

APPENDIXES

What's In Part III

This part provides additional technical information about the Portégé 610CT computer. Review this material if you have additional questions or need additional information.

Features and Specifications

This appendix lists the features of the Portégé 610CT computer and summarizes its specifications.

Built-in Features

This section lists the Portégé 610CT features.

Technology and Processor

Microprocessor	90MHz Intel Pentium with Voltage Reduction Technology
LSI and CMOS	large scale integrated and complementary metal-oxide semiconductor technology, providing minimum size and weight, low power usage and high reliability

ECP the Portégé 610CT parallel port supports Enhanced Capability Port (ECP), providing increased performance when you're using an ECP-compatible parallel device

Power

Computer 15V input voltage (constant voltage)
1.4 amps maximum (constant current)

AC adapter 100 to 240 volts alternating current
50 or 60 hertz (cycles per second)

Main battery removable, rechargeable lithium ion battery pack

Backup battery provides power for special memory features, such as Resume Mode

RTC battery provides power for the internal real-time clock and calendar

Intelligent power supply detects low battery charge and displays the time remaining, in MaxTime

Automatic power off saves battery power by automatically turning off the display and hard disk when either have not been accessed for a set length of time

Storage Capacity

External 3 1/2" diskette drive	accommodates both 1.44MB, high density (2HD) and 720KB, double-density (2DD) diskettes
Hard disk	2 1/2" integrated drive and controller provides nonvolatile storage for 686MB with an average access time of 13 milliseconds (ms).

Ports

Parallel port	selectable, ECP-compatible parallel port that provides a Centronics-compatible connection to a printer or other parallel device
Serial port	9-pin, RS-232-C-compatible serial port lets you connect an external modem, mouse, serial printer or other serial device
Video/Port Replicator port	72-pin, analog VGA port lets you connect an external VGA adapter for an external monitor, or an optional Port Replicator
External diskette drive port	lets you attach the Toshiba 1.44MB external 3 1/2" diskette drive

Standard Hardware

Memory	8MB that uses 3.3 volt, 4-megabit dynamic RAM chips for 640KB conventional and 7360KB extended memory
Display	the Portégé 610CT has a 9.5 inch (measured diagonally) active matrix Thin Film Transistor (TFT) color LCD that displays up to 16Mcolors simultaneously at 640 x 480 resolution
Keyboard	enhanced 82-key (84-key in Europe) keyboard emulates the IBM PS/2 keyboard and includes embedded numeric and cursor control overlays and dedicated cursor control keys
AccuPoint and buttons	provides the complete function of a mouse or other pointing device from within the keyboard
External VGA adapter	provides compatibility between the Video/Port Replicator port and an external monitor
External diskette drive	accommodates both 1.44MB and 720KB 3 1/2" diskettes

Standard Software

Operating System	Toshiba MS-DOS
Operating Environment	Microsoft Windows for Workgroups 3.11 with SVGA drivers and the MaxTime power management program
Configuration Programs	Hardware Setup and TSETUP let you change configuration options and set preferences
Power	APM device driver and MaxTime monitor the battery charge and provide access to the Portégé 610CT's power-saving features
Toshiba Card Manager	provides support for optional PC cards (PCMCIA-compatible)

Special Features

Resume Mode	electronic bookmark that records what you're doing when you turn the computer off and returns you to the same place when you turn the power back on
Advanced Power Management	determines the system's power needs and automatically configures the computer for maximum power savings
Security	instant and power-on passwords help protect your files

Documentation

User's Guide	explains how to set up the computer, gives instructions for basic computing tasks and documents all system components and features
Online Documentation	provides the <i>Portégé 610CT User's Guide</i> in hypertext form Load this manual into memory and refer to it when you have questions about the computer.
MS-DOS documentation	documents the MS-DOS operating system and describes its commands
Microsoft Windows documentation	documents the Microsoft Windows operating environment

Optional Accessories and Devices

This section lists the options available for the Portégé 610CT computer.

Power Devices

Battery charger	charges extra battery packs
Additional battery packs	use as spare or replacement packs to extend the time you can operate the computer away from a live wall outlet

Memory Cards

8MB	expands the computer's memory to 16MB
16MB	expands the computer's memory to 24MB
32MB	expands the computer's memory to 40MB

Expansion Capability

PC card slot	lets you install up to two Type I or Type II PC cards, or one Type III PC card. Maximum slot thickness: 10.5mm
Port Replicator	optional docking station that provides access to the following: parallel port, serial port, video port, PS/2 keyboard port, PS/2 mouse port, external diskette drive port, security lock slot, power socket

310 *Specifications*

Others

Carrying case sturdy fabric or leather carrying case protects the computer while traveling

Security

Cable Kensington MicroSave Security System cable to deter computer theft

Specifications

Physical Dimensions

Weight 4.8 lbs (2.2 kilograms) including battery

Size width x depth x height
9.88" x 7.91" x 1.89" (251mm x 201mm x 48mm)

Environmental Specifications

<i>Condition</i>	<i>Ambient Temperature</i>	<i>Relative Humidity</i>	<i>Altitude (From Sea Level)</i>
Operating	41° to 95° F 5° to 35° C	20% to 80% (non-condensing)	-200 to 10,000 feet (-60 to 3,000 meters)
Nonoperating	-4° to 149° F -20° to 65° C	10% to 90% (non-condensing)	-200 to 30,000 feet (-60 to 10,000 meters)
Wet-bulb temperature	79° F 26° C maximum		

Power Cord Connectors

The Portégé 610CT computer features a universal power supply you can use worldwide. This appendix shows the shapes of the typical AC power cord connectors for various parts of the world.

USA and Canada

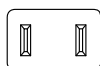

UL approved
CSA approved

Australia



AS approved

United Kingdom



BS approved

Europe



VDA approved
NEMKO approved

System Resources

This appendix lists the preassigned IRQ levels, DMA channels and I/O port addresses.

IRQ Level Assignments

The direct line to the CPU is called an Interrupt ReQuest (IRQ) level or channel. You'll hear both terms used by technical experts. They mean the same thing. The following table lists the IRQ level assignments for the Portégé 610CT computer:

<i>IRQ</i>	<i>Use</i>	<i>Notes</i>
0	Timer	
1	Keyboard	
2	PIC #2	
3	COM2	

316 *IRQ Level Assignments*

<i>IRQ</i>	<i>Use</i>	<i>Notes</i>
4	COM1	
5	Reserved	
6	3 1/2" diskette drive	
7	LPT1	ECP
8	Real-time clock	
9	Software redirect to INT 0Ah,	ECP
10	Reserved	ECP
11	Reserved	
12	Reserved	
13	Numeric data processor	
14	Hard disk	
15	Reserved	This IRQ is available if Card Services is not loaded.

DMA Channel Assignments

Direct Memory Access (DMA) allows some devices to transfer data to and from memory at high speeds, without using the CPU. Such devices are each assigned a unique DMA channel. The Portégé 610CT computer has two DMA controllers with four channels on each controller, a total of eight DMA channels.

The following table lists the Portégé 610CT computer's DMA channel assignments.

<i>DMA</i>	<i>Use</i>	<i>Notes</i>
0	Reserved	
1	Reserved	
2	3 1/2" diskette drive	
3	Reserved	
4	Cascade from DMAC 1	
5	Reserved	
6	Reserved	
7	Reserved	

Input/Output Port Address Assignments

The CPU accesses input/output devices, such as modems, by reading from them or writing to them. Each command to read or write must specify the address (in memory) for the port. Each device that communicates with the CPU must have a unique I/O port address.

318 *Input/Output Port Address Assignments*

The following table lists the device names and their assigned I/O port addresses for the Portégé 610CT computer.

<i>Port address(h)</i>	<i>Device/function</i>	<i>Notes</i>
000-01F	82C37: DMA Controller 1	
020-03F	82C59: PIC 1	
040-05F	82C54: Timer	
060-06F	Keyboard Controller	060 and 064 are KBC. 061 is system status port.
070	NMI mask register	
070-07F	Real Time Clock	
080-09F	DMA page register	
0A0-0BF	82C59: PIC 2	
0C0-0DF	82C37: DMA Controller 2	
0E0-0EF	Special Register	
0F0-0F7	Math Coprocessor	
100-1EF	VGA	
1F0-1FF	Hard Disk Controller	

<i>Port address(h)</i>	<i>Device/function</i>	<i>Notes</i>
201	Not used	
202-21F	Not used	
220-22F	Not used	Sound System default
230-23F	Not used	Available for Sound System
240-24F	Not used	Available for Sound System
250-25F	Not used	Available for Sound System
260-277	Not used	
278-27F	Parallel PRT 2	
280-2F7	Not used	
2F8-2FF	Serial Port 2 (COM2)	
300-33F	Not used	
340-35F	Not used	
360-377	Not used	
378-37F	Parallel PRT 1	
380-387	Not used	

320 *Input/Output Port Address Assignments*

<i>Port address(h)</i>	<i>Device/function</i>	<i>Notes</i>
388-38B	Not used	
38C-38F	Not used	
390-39F	Not used	
3A0-3AF	Bisynchronous 1	
3B0-3BF	Parallel PRT 3	
3C0-3DF	CGA, EGA, VGA,	
3E0-3EF	Not used	
3F0-3F7	3 1/2" diskette drive controller	I/O ports 3F6 and 3F7 are used for the HDC also.
3F8-3FF	Serial Port (COM1)	
400-47F	Not used	
480-49F	DMA High-Page Register	

Video Modes

This appendix lists the video modes supported by the Portégé 610CT display adapter, and identifies the characteristics of each mode.

The columns of the following tables are defined as follows:

Mode is the mode number in hexadecimal, and is generally used by programmers to specify video modes in programs.

Type identifies the display adapter that first supported the mode, and specifies whether the mode is text or graphics.

Resolution is the measure of the screen's dimensions in terms of horizontal and vertical pixels (in graphics modes), or rows and columns of characters (in text modes).

Grid is the default number of pels per character.

LCD Colors is the maximum number of simultaneous colors, or shades of gray, that the mode can display on the built-in screen.

CRT Colors is the maximum number of simultaneous colors, or shades of gray, that the mode can display on an external monitor.

Scan Freq hor/vert is the horizontal and vertical scanning frequency in Hertz. This is for external monitors only.

Portégé 610CT Video Modes

This table lists the video modes for the Portégé 610CT computer:

Mode (hex)	Type	Resolution	Internal LCD		External Monitor		Scan Freq hor/vert
			Grid (pel x pel)	Colors	Grid (pel x pel)	Colors	
0, 1	VGA Text	40 x 25	8 x 8	16/256K	8 x 8	16/256K	31.5KHz/ 70Hz
2, 3	VGA Text	80 x 25	8 x 8	16/256K	8 x 8	16/256K	31.5KHz/ 70Hz
0*, 1*	VGA Text	40 x 25	8 x 14	16/256K	8 x 14	16/256K	31.5KHz/ 70Hz
2*, 3*	VGA Text	80 x 25	8 x 14	16/256K	8 x 14	16/256K	31.5KHz/ 70Hz
0+, 1+	VGA Text	40 x 25	9 x 16	16/256K	9 x 16	16/256K	31.5KHz/ 70Hz
2+, 3+	VGA Text	80 x 25	9 x 16	16/256K	9 x 16	16/256K	31.5KHz/ 70Hz
4, 5	VGA Graph	320 x 200	8 x 8	4/256K	8 x 8	4/256K	31.5KHz/ 70Hz
6	VGA Graph	640 x 200	8 x 8	2/256K	8 x 8	2/256K	31.5KHz/ 70Hz
7	VGA Text	80 x 25	9 x 14	Mono	9 x 14	Mono	31.5KHz/ 70Hz
7+	VGA Text	80 x 25	9 x 16	Mono	9 x 16	Mono	31.5KHz/ 70Hz
D	VGA Graph	320 x 200	8 x 8	16/256K	8 x 8	16/256K	31.5KHz/ 70Hz
E	VGA Graph	640 x 200	8 x 8	16/256K	8 x 8	16/256K	31.5KHz/ 70Hz
F	VGA Graph	640 x 350	8 x 14	Mono	8 x 14	Mono	31.5KHz/ 70Hz
10	VGA Graph	640 x 350	8 x 14	16/256K	8 x 14	16/256K	31.5KHz/ 70Hz
11	VGA Graph	640 x 480	8 x 16	2/256K	8 x 16	2/256K	31.5KHz/ 60Hz
12	VGA Graph	640 x 480	8 x 16	16/256K	8 x 16	16/256K	31.5KHz/ 60Hz
13	VGA Graph	320 x 200	8 x 8	256/256K	8 x 8	256/ 256K	31.5KHz/ 70Hz
20	SVGA Graph	640 x 480	8 x 16	16/256K	8 x 16	16/256K	31.5KHz/ 72Hz

<i>Mode (hex)</i>	<i>Type</i>	<i>Resolution</i>	<i>Internal LCD</i>		<i>External Monitor</i>		<i>Scan Freq hor/vert</i>
			<i>Grid (pel x pel)</i>	<i>Colors</i>	<i>Grid (pel x pel)</i>	<i>Colors</i>	
22	SVGA Graph	800 x 600	8 x 8	16/256K	8 x 8	16/256K	37.5KHz/ 72Hz
24	SVGA Graph	1024 x 768	8 x 16	16/256K	8 x 16	16/256K	48.5KHz/ 60Hz
30	SVGA Graph	640 x 480	8 x 16	256/256K	8 x 16	256/ 256K	31.5KHz/ 72Hz
32	SVGA Graph	800 x 600	8 x 16	256/256K	8 x 16	256/ 256K	48.0KHz/ 72Hz
34	SVGA Graph	1024 x 768	8 x 16	256/256K	8 x 16	256/ 256K	48.5KHz/ 60Hz
40	SVGA Graph	640 x 480	8 x 16	32K/32K	8 x 16	32K/ 32K	31.5KHz/ 60Hz
41	SVGA Graph	640 x 480	8 x 16	64K/64K	8 x 16	64K/ 64K	31.5KHz/ 60Hz