



Post Office Box 579, Pacific Grove, California 93950, (408) 649-3896

**ED: A CONTEXT EDITOR FOR THE CP/M DISK SYSTEM  
USER'S MANUAL**

**COPYRIGHT (c) 1976, 1978**

**DIGITAL RESEARCH**

Copyright (c) 1976, 1978 by Digital Research. All rights reserved. No part of this publication may be reproduced, transmitted, transcribed, stored in a retrieval system, or translated into any language or computer language, in any form or by any means, electronic, mechanical, magnetic, optical, chemical, manual or otherwise, without the prior written permission of Digital Research, Post Office Box 579, Pacific Grove, California 93950.

Disclaimer

Digital Research makes no representations or warranties with respect to the contents hereof and specifically disclaims any implied warranties of merchantability or fitness for any particular purpose. Further, Digital Research reserves the right to revise this publication and to make changes from time to time in the content hereof without obligation of Digital Research to notify any person of such revision or changes.

# DIGITAL RESEARCH

Post Office Box 579, Pacific Grove, California 93950, (408) 649-3896

## ED: A CONTEXT EDITOR FOR THE CP/M DISK SYSTEM USER'S MANUAL

COPYRIGHT (c) 1976, 1978  
DIGITAL RESEARCH

Copyright (c) 1976, 1978 by Digital Research. All rights reserved. No part of this publication may be reproduced, transmitted, transcribed, stored in a retrieval system, or translated into any language or computer language, in any form or by any means, electronic, mechanical, magnetic optical, chemical, manual or otherwise, without the prior written permission of Digital Research, Post Office Box 579, Pacific Grove, California 93950.

#### Disclaimer

Digital Research makes no representations or warranties with respect to the contents hereof and specifically disclaims any implied warranties of merchantability or fitness for any particular purpose. Further, Digital Research reserves the right to revise this publication and to make changes from time to time in the content hereof without obligation of Digital Research to notify any person of such revision or changes.

## Table of Contents

1.	ED TUTORIAL . . . . .	1
1.1	Introduction to ED . . . . .	1
1.2	ED Operation . . . . .	1
1.3	Text Transfer Functions . . . . .	1
1.4	Memory Buffer Organization . . . . .	5
1.5	Memory Buffer Operation . . . . .	5
1.6	Command Strings . . . . .	7
1.7	Text Search and Alteration . . . . .	8
1.8	Source Libraries . . . . .	11
1.9	Repetitive Command Execution . . . . .	12
2.	ED ERROR CONDITIONS . . . . .	13
3.	CONTROL CHARACTERS AND COMMANDS . . . . .	14



## ED USER'S MANUAL

### 1. ED TUTORIAL

#### 1.1. Introduction to ED.

ED is the context editor for CP/M, and is used to create and alter CP/M source files. ED is initiated in CP/M by typing

$$\text{ED} \left\{ \begin{array}{l} \langle \text{filename} \rangle \\ \langle \text{filename} \rangle . \langle \text{filetype} \rangle \end{array} \right\}$$

In general, ED reads segments of the source file given by `<filename>` or `<filename> . <filetype>` into central memory, where the file is manipulated by the operator, and subsequently written back to disk after alterations. If the source file does not exist before editing, it is created by ED and initialized to empty. The overall operation of ED is shown in Figure 1.

#### 1.2. ED Operation

ED operates upon the source file, denoted in Figure 1 by `x.y`, and passes all text through a memory buffer where the text can be viewed or altered (the number of lines which can be maintained in the memory buffer varies with the line length, but has a total capacity of about 6000 characters in a 16K CP/M system). Text material which has been edited is written onto a temporary work file under command of the operator. Upon termination of the edit, the memory buffer is written to the temporary file, followed by any remaining (unread) text in the source file. The name of the original file is changed from `x.y` to `x.BAK` so that the most recent previously edited source file can be reclaimed if necessary (see the CP/M commands ERASE and RENAME). The temporary file is then changed from `x.$$$` to `x.y` which becomes the resulting edited file.

The memory buffer is logically between the source file and working file as shown in Figure 2.

#### 1.3. Text Transfer Functions

Given that `n` is an integer value in the range 0 through 65535, the following ED commands transfer lines of text from the source file through the memory buffer to the temporary (and eventually final) file:

Figure 1. Overall ED Operation

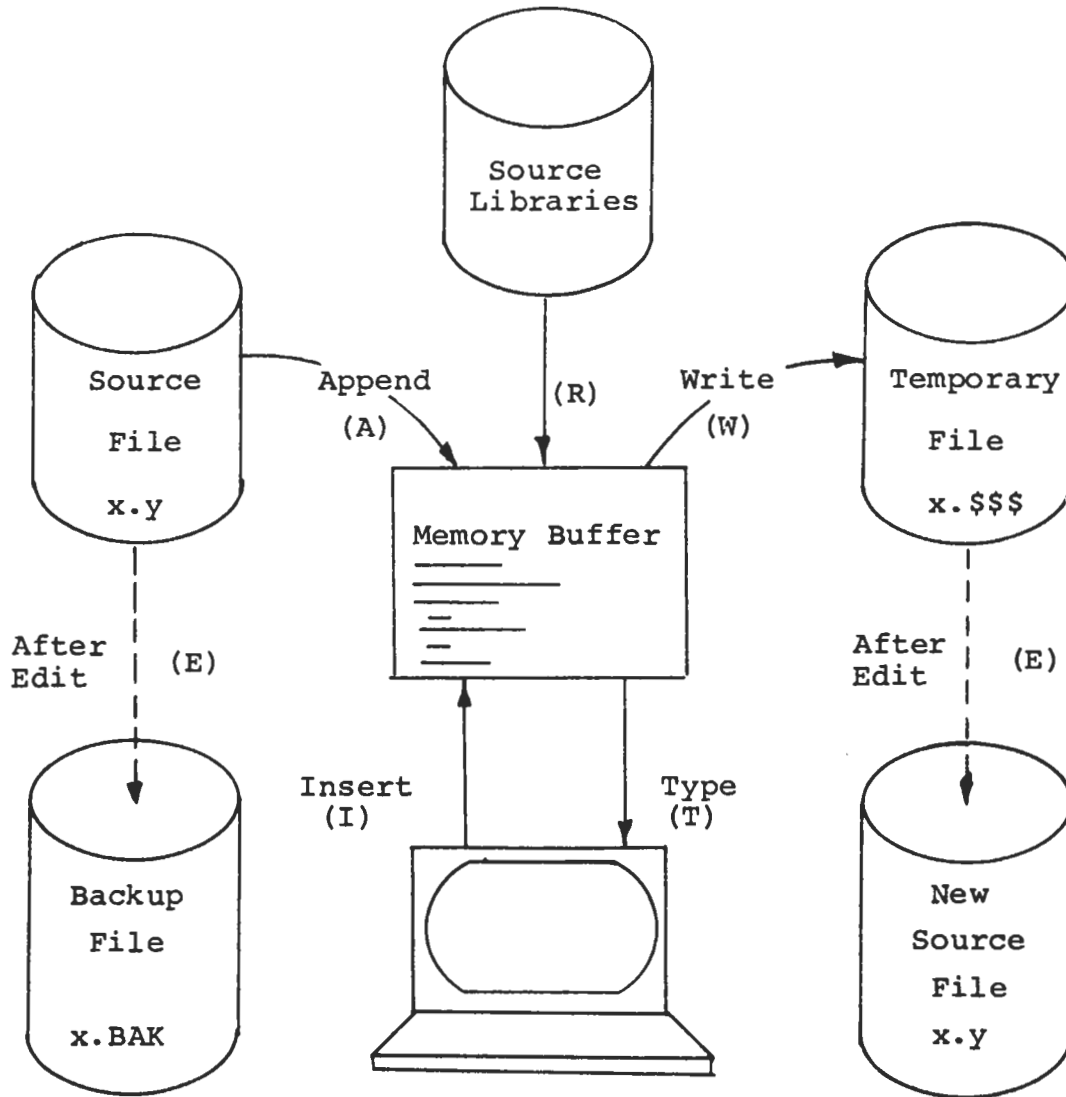

Note: the ED program accepts both lower and upper case ASCII characters as input from the console. Single letter commands can be typed in either case. The U command can be issued to cause ED to translate lower case alphabets to upper case as characters are filled to the memory buffer from the console. Characters are echoed as typed without translation, however. The -U command causes ED to revert to "no translation" mode. ED starts with an assumed -U in effect.



Figure 2. Memory Buffer Organization

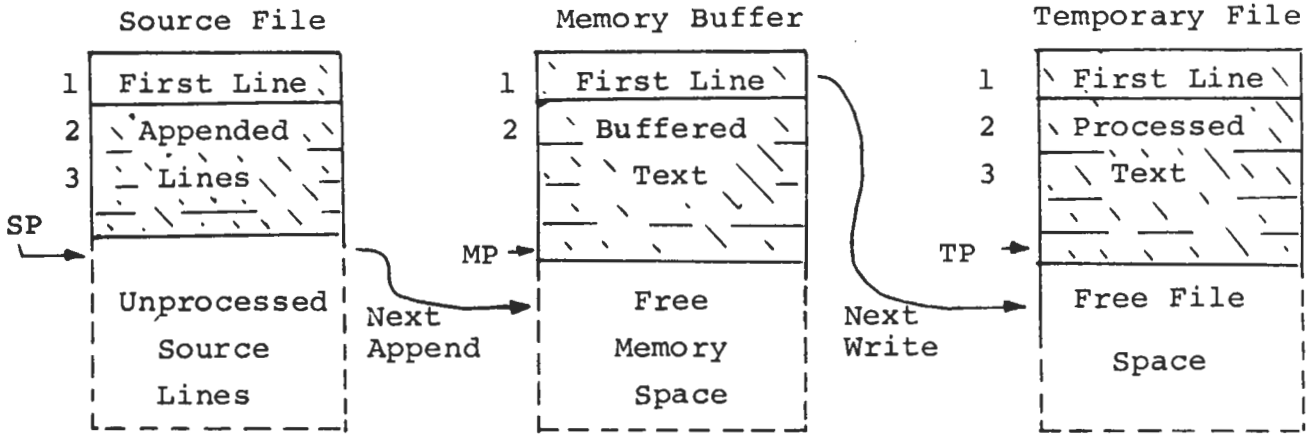
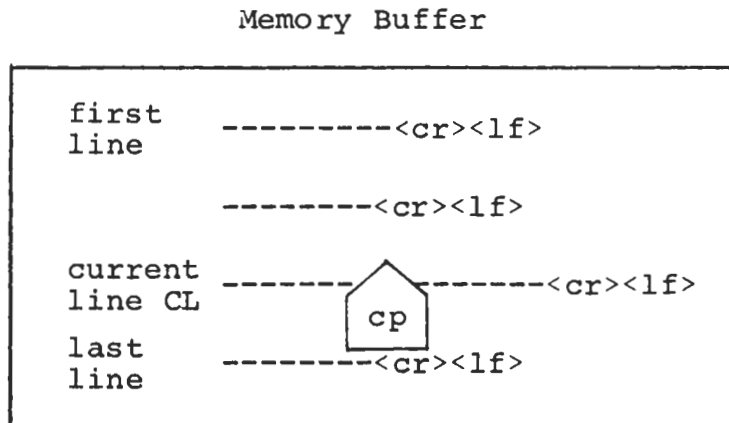

Figure 3. Logical Organization of Memory Buffer



- nA<cr>\* - append the next n unprocessed source lines from the source file at SP to the end of the memory buffer at MP. Increment SP and MP by n.
  
- nW<cr> - write the first n lines of the memory buffer to the temporary file free space. Shift the remaining lines n+1 through MP to the top of the memory buffer. Increment TP by n.
  
- E<cr> - end the edit. Copy all buffered text to temporary file, and copy all unprocessed source lines to the temporary file. Rename files as described previously.
  
- H<cr> - move to head of new file by performing automatic E command. Temporary file becomes the new source file, the memory buffer is emptied, and a new temporary file is created (equivalent to issuing an E command, followed by a reinvocation of ED using x.y as the file to edit).
  
- O<cr> - return to original file. The memory buffer is emptied, the temporary file id deleted, and the SP is returned to position 1 of the source file. The effects of the previous editing commands are thus nullified.
  
- Q<cr> - quit edit with no file alterations, return to CP/M.

There are a number of special cases to consider. If the integer n is omitted in any ED command where an integer is allowed, then 1 is assumed. Thus, the commands A and W append one line and write 1 line, respectively. In addition, if a pound sign (#) is given in the place of n, then the integer 65535 is assumed (the largest value for n which is allowed). Since most reasonably sized source files can be contained entirely in the memory buffer, the command #A is often issued at the beginning of the edit to read the entire source file to memory. Similarly, the command #W writes the entire buffer to the temporary file. Two special forms of the A and W

---

\*<cr> represents the carriage-return key

commands are provided as a convenience. The command OA fills the current memory buffer to at least half-full, while OW writes lines until the buffer is at least half empty. It should also be noted that an error is issued if the memory buffer size is exceeded. The operator may then enter any command (such as W) which does not increase memory requirements. The remainder of any partial line read during the overflow will be brought into memory on the next successful append.

#### 1.4. Memory Buffer Organization

The memory buffer can be considered a sequence of source lines brought in with the A command from a source file. The memory buffer has an associated (imaginary) character pointer CP which moves throughout the memory buffer under command of the operator. The memory buffer appears logically as shown in Figure 3 where the dashes represent characters of the source line of indefinite length, terminated by carriage-return (<cr>) and line-feed (<lf>) characters, and  represents the imaginary character pointer. Note that the CP is always located ahead of the first character of the first line, behind the last character of the last line, or between two characters. The current line CL is the source line which contains the CP.

#### 1.5. Memory Buffer Operation

Upon initiation of ED, the memory buffer is empty (ie, CP is both ahead and behind the first and last character). The operator may either append lines (A command) from the source file, or enter the lines directly from the console with the insert command

I<cr>

ED then accepts any number of input lines, where each line terminates with a <cr> (the <lf> is supplied automatically), until a control-z (denoted by ↑z is typed by the operator). The CP is positioned after the last character entered. The sequence

```
I<cr>
NOW IS THE<cr>
TIME FOR<cr>
ALL GOOD MEN<cr>
↑z
```

leaves the memory buffer as shown below

NOW IS THE<cr><lf>  
TIME FOR<cr><lf>  
ALL GOOD MEN<cr><lf>



Various commands can then be issued which manipulate the CP or display source text in the vicinity of the CP. The commands shown below with a preceding n indicate that an optional unsigned value can be specified. When preceded by ±, the command can be unsigned, or have an optional preceding plus or minus sign. As before, the pound sign (#) is replaced by 65535. If an integer n is optional, but not supplied, then n=1 is assumed. Finally, if a plus sign is optional, but none is specified, then + is assumed.

- ±B<cr> - move CP to beginning of memory buffer if +, and to bottom if -.
- ±nC<cr> - move CP by ±n characters (toward front of buffer if +), counting the <cr><lf> as two distinct characters
- ±nD<cr> - delete n characters ahead of CP if plus and behind CP if minus.
- ±nK<cr> - kill (ie remove) ±n lines of source text using CP as the current reference. If CP is not at the beginning of the current line when K is issued, then the characters before CP remain if + is specified, while the characters after CP remain if - is given in the command.
- ±nL<cr> - if n=0 then move CP to the beginning of the current line (if it is not already there) if n≠0 then first move the CP to the beginning of the current line, and then move it to the beginning of the line which is n lines down (if +) or up (if -). The CP will stop at the top or bottom of the memory buffer if too large a value of n is specified.

$\pm nT<cr>$  - If  $n=0$  then type the contents of the current line up to CP. If  $n=1$  then type the contents of the current line from CP to the end of the line. If  $n>1$  then type the current line along with  $n-1$  lines which follow, if + is specified. Similarly, if  $n>1$  and - is given, type the previous  $n$  lines, up to the CP. The break key can be depressed to abort long type-outs.



$\pm n<cr>$  - equivalent to  $\pm nLT$ , which moves up or down and types a single line





### 1.6. Command Strings

Any number of commands can be typed contiguously (up to the capacity of the CP/M console buffer), and are executed only after the  $<cr>$  is typed. Thus, the operator may use the CP/M console command functions to manipulate the input command:

Rubout	remove the last character
Control-U	delete the entire line
Control-C	re-initialize the CP/M System
Control-E	return carriage for long lines without transmitting buffer (max 128 chars)

Suppose the memory buffer contains the characters shown in the previous section, with the CP following the last character of the buffer. The command strings shown below produce the results shown to the right

<u>Command String</u>	<u>Effect</u>	<u>Resulting Memory Buffer</u>
1. B2T<cr>	move to beginning of buffer and type 2 lines: "NOW IS THE TIME FOR"	 NOW IS THE<cr><lf> TIME FOR<cr><lf> ALL GOOD MEN<cr><lf>
2. 5C0T<cr>	move CP 5 characters and type the beginning of the line "NOW I"	NOW I  S THE<cr><lf>

- |    |  |   |   |
|----|--|---|---|
| 3. | 2L-T<cr>                                 | move two lines down<br>and type previous<br>line<br>"TIME FOR"            | NOW IS THE<cr><lf><br>TIME FOR<cr><lf><br>ALL GOOD MEN<cr><lf>                      |
|    |  |   |    |
| 4. | -L#K<cr>                                 | move up one line,<br>delete 65535 lines<br>which follow                   | NOW IS THE<cr><lf>  |
|    |  |   |  |
| 5. | I<cr><br>TIME TO<cr><br>INSERT<cr><br>↑z | insert two lines<br>of text   | NOW IS THE<cr><lf><br>TIME TO<cr><lf><br>INSERT<cr><lf>                             |
|    |  |   |  |
| 6. | -2L#T<cr>                                | move up two lines,<br>and type 65535<br>lines ahead of CP<br>"NOW IS THE" | NOW IS THE<cr><lf><br>TIME TO<cr><lf><br>INSERT<cr><lf>                             |
|    |  |   |  |
| 7. | <cr>                                     | move down one line<br>and type one line<br>"INSERT"                       | NOW IS THE<cr><lf><br>TIME TO<cr><lf><br>INSERT<cr><lf>                             |
|    |  |   |  |

### 1.7. Text Search and Alteration

ED also has a command which locates strings within the memory buffer. The command takes the form



$$nF c_1 c_2 \dots c_k \left\{ \begin{array}{l} \langle cr \rangle \\ \uparrow z \end{array} \right\}$$

where  $c_1$  through  $c_k$  represent the characters to match followed by either a <cr> or control -z\*. ED starts at the current position of CP and attempts to match all k characters. The match is attempted n times, and if successful, the CP is moved directly after the character  $c_k$ . If the n matches are not successful, the CP is not moved from its initial position. Search strings can include  $\uparrow 1$  (control-1), which is replaced by the pair of symbols <cr><lf>.

---

\*The control-z is used if additional commands will be typed following the  $\uparrow z$ .

The following commands illustrate the use of the F command:

<u>Command String</u>	<u>Effect</u>	<u>Resulting Memory Buffer</u>
1. B#T<cr>	move to beginning and type entire buffer	 NOW IS THE<cr><lf> TIME FOR<cr><lf> ALL GOOD MEN<cr><lf>
2. FS T<cr>	find the end of the string "S T"	NOW IS T  HE<cr><lf>
3. FI↑z0TT	find the next "I" and type to the CP then type the remainder of the current line: "TIME FOR"	NOW IS THE<cr><lf> TI  ME FOR<cr><lf> ALL GOOD MEN<cr><lf>

An abbreviated form of the insert command is also allowed, which is often used in conjunction with the F command to make simple textual changes. The form is:

I c<sub>1</sub>c<sub>2</sub>... c<sub>n</sub>↑z or

I c<sub>1</sub>c<sub>2</sub>... c<sub>n</sub><cr>

where c<sub>1</sub> through c<sub>n</sub> are characters to insert. If the insertion string is terminated by a ↑z, the characters c<sub>1</sub> through c<sub>n</sub> are inserted directly following the CP, and the CP is moved directly after character c<sub>n</sub>. The action is the same if the command is followed by a <cr> except that a <cr><lf> is automatically inserted into the text following character c<sub>n</sub>. Consider the following command sequences as examples of the F and I commands:

<u>Command String</u>	<u>Effect</u>	<u>Resulting Memory Buffer</u>
BITHIS IS ↑z<cr>	Insert "THIS IS " at the beginning of the text	THIS IS NOW THE <cr><lf>  TIME FOR<cr><lf> ALL GOOD MEN<cr><lf>

FTIME↑z-4DIPLACE↑z<cr>

find "TIME" and delete it; then insert "PLACE"

THIS IS NOW THE<cr><lf>  
PLACE  FOR<cr><lf>  
ALL GOOD MEN<cr><lf>

3FO↑z-3D5DICHANGES↑<cr>

find third occurrence of "O" (ie the second "O" in GOOD), delete previous 3 characters; then insert "CHANGES"

THIS IS NOW THE <cr><lf>  
PLACE FOR<cr><lf>  
ALL CHANGES  <cr><lf>

-8CISOURCE<cr> move back 8 characters and insert the line "SOURCE<cr><lf>"

THIS IS NOW THE<cr><lf>  
PLACE FOR<cr><lf>  
ALL SOURCE<cr><lf>  
 CHANGES<cr><lf>

ED also provides a single command which combines the F and I commands to perform simple string substitutions. The command takes the form

$$n S c_1 c_2 \dots c_k \uparrow z d_1 d_2 \dots d_m \left\{ \begin{array}{l} \langle cr \rangle \\ \uparrow z \end{array} \right\}$$

and has exactly the same effect as applying the command string

$$F c_1 c_2 \dots c_k \uparrow z -k D I d_1 d_2 \dots d_m \left\{ \begin{array}{l} \langle cr \rangle \\ \uparrow z \end{array} \right\}$$

a total of n times. That is, ED searches the memory buffer starting at the current position of CP and successively substitutes the second string for the first string until the end of buffer, or until the substitution has been performed n times.

As a convenience, a command similar to F is provided by ED which automatically appends and writes lines as the search proceeds. The form is

$$n N c_1 c_2 \dots c_k \left\{ \begin{array}{l} cr \\ \uparrow z \end{array} \right\}$$

which searches the entire source file for the nth occurrence of the string  $c_1 c_2 \dots c_k$  (recall that F fails if the string cannot be found in the current buffer). The operation of the



N command is precisely the same as F except in the case that the string cannot be found within the current memory buffer. In this case, the entire memory contents is written (ie, an automatic #W is issued). Input lines are then read until the buffer is at least half full, or the entire source file is exhausted. The search continues in this manner until the string has been found n times, or until the source file has been completely transferred to the temporary file.

A final line editing function, called the juxtaposition command takes the form

$$n J c_1 c_2 \dots c_k \uparrow z d_1 d_2 \dots d_m \uparrow z e_1 e_2 \dots e_q \left\{ \begin{array}{l} \langle cr \rangle \\ \uparrow z \end{array} \right\}$$

with the following action applied n times to the memory buffer: search from the current CP for the next occurrence of the string  $c_1 c_2 \dots c_k$ . If found, insert the string  $d_1 d_2 \dots d_m$ , and move CP to follow  $d_m$ . Then delete all characters following CP up to (but not including) the string  $e_1 e_2 \dots e_q$ , leaving CP directly after  $d_m$ . If  $e_1 e_2 \dots e_q$  cannot be found, then no deletion is made. If the current line is

cp NOW IS THE TIME<cr><lf>

Then the command

JW  $\uparrow z$ WHAT $\uparrow z \uparrow 1$ <cr>

Results in

NOW WHAT cp <cr><lf>

(Recall that  $\uparrow 1$  represents the pair <cr><lf> in search and substitute strings).

It should be noted that the number of characters allowed by ED in the F,S,N, and J commands is limited to 100 symbols.

### 1.8. Source Libraries

ED also allows the inclusion of source libraries during the editing process with the R command. The form of this command is

R f<sub>1</sub>f<sub>2</sub>..f<sub>n</sub>↑z      or

R f<sub>1</sub>f<sub>2</sub>..f<sub>n</sub><cr>

where f<sub>1</sub>f<sub>2</sub>..f<sub>n</sub> is the name of a source file on the disk with as assumed filetype of 'LIB'. ED reads the specified file, and places the characters into the memory buffer after CP, in a manner similar to the I command. Thus, if the command

RMACRO<cr>

is issued by the operator, ED reads from the file MACRO.LIB until the end-of-file, and automatically inserts the characters into the memory buffer.

### 1.9. Repetitive Command Execution

The macro command M allows the ED user to group ED commands together for repeated evaluation. The M command takes the form:

$$n \ M \ c_1 c_2 \dots c_k \ \left\{ \begin{array}{l} \langle \text{cr} \rangle \\ \uparrow z \end{array} \right\}$$

where c<sub>1</sub>c<sub>2</sub>..c<sub>k</sub> represent a string of ED commands, not including another M command. ED executes the command string n times if n>1. If n=0 or 1, the command string is executed repetitively until an error condition is encountered (e.g., the end of the memory buffer is reached with an F command).

As an example, the following macro changes all occurrences of GAMMA to DELTA within the current buffer, and types each line which is changed:

MFGAMMA↑z-5DIDELTA↑z0TT<cr>

or equivalently

MSGAMMA↑zDELTA↑z0TT<cr>

## 2. ED ERROR CONDITIONS

On error conditions, ED prints the last character read before the error, along with an error indicator:

?	unrecognized command
>	memory buffer full (use one of the commands D,K,N,S, or W to remove characters), F,N, or S strings too long.
#	cannot apply command the number of times specified (e.g., in F command)
O	cannot open LIB file in R command

Cyclic redundancy check (CRC) information is written with each output record under CP/M in order to detect errors on subsequent read operations. If a CRC error is detected, CP/M will type

```
PERM ERR DISK d
```

where d is the currently selected drive (A,B,...). The operator can choose to ignore the error by typing any character at the console (in this case, the memory buffer data should be examined to see if it was incorrectly read), or the user can reset the system and reclaim the backup file, if it exists. The file can be reclaimed by first typing the contents of the BAK file to ensure that it contains the proper information:

```
TYPE x.BAK<cr>
```

where x is the file being edited. Then remove the primary file:

```
ERA x.y<cr>
```

and rename the BAK file:

```
REN x.y=x.BAK<cr>
```

The file can then be re-edited, starting with the previous version.

### 3. CONTROL CHARACTERS AND COMMANDS

The following table summarizes the control characters and commands available in ED:

<u>Control Character</u>	<u>Function</u>
↑c	system reboot
↑e	physical <cr><lf> (not actually entered in command)
↑i	logical tab (cols 1,8,15,...)
↑l	logical <cr><lf> in search and substitute strings
↑u	line delete
↑z	string terminator
rubout	character delete
break	discontinue command (e.g., stop typing)

<u>Command</u>	<u>Function</u>
nA	append lines
±B	begin bottom of buffer
±nC	move character positions
±nD	delete characters
E	end edit and close files (normal end)
nF	find string
H	end edit, close and reopen files
I	insert characters
nJ	place strings in juxtaposition
±nK	kill lines
±nL	move down/up lines
nM	macro definition
nN	find next occurrence with autoscan
O	return to original file
±nP	move and print pages
Q	quit with no file changes
R	read library file
nS	substitute strings
±nT	type lines
± U	translate lower to upper case if U, no translation if -U
nW	write lines
nZ	sleep
±n<cr>	move and type (±nLT)



## Appendix A: ED 1.4 Enhancements

The ED context editor contains a number of commands which enhance its usefulness in text editing. The improvements are found in the addition of line numbers, free space interrogation, and improved error reporting.

The context editor issued with CP/M 1.4 produces absolute line number prefixes when the "V" (Verify Line Numbers) command is issued. Following the V command, the line number is displayed ahead of each line in the format:

nnnnn:

where nnnnn is an absolute line number in the range 1 to 65535. If the memory buffer is empty, or if the current line is at the end of the memory buffer, then nnnnn appears as 5 blanks.

The user may reference an absolute line number by preceding any command by a number followed by a colon, in the same format as the line number display. In this case, the ED program moves the current line reference to the absolute line number, if the line exists in the current memory buffer. Thus, the command

345:T

is interpreted as "move to absolute line 345, and type the line." Note that absolute line numbers are produced only during the editing process, and are not recorded with the file. In particular, the line numbers will change following a deleted or expanded section of text.

The user may also reference an absolute line number as a backward or forward distance from the current line by preceding the absolute line number by a colon. Thus, the command

:400T

is interpreted as "type from the current line number through the line whose absolute number is 400." Combining the two line reference forms, the command

345::400T

for example, is interpreted as "move to absolute line 345, then type through absolute line 400." Note that absolute line references of this sort can precede any of the standard ED commands.

A special case of the V command, "ØV", prints the memory buffer statistics in the form:

free/total

where "free" is the number of free bytes in the memory buffer (in decimal), and "total" is the size of the memory buffer.

ED 1.4 also includes a "block move" facility implemented through the "X" (Xfer) command. The form

nX

transfers the next n lines from the current line to a temporary file called

X\$\$\$\$\$.LIB

which is active only during the editing process. In general, the user can reposition the current line reference to any portion of the source file and transfer lines to the temporary file. The transferred lines accumulate one after another in this file, and can be retrieved by simply typing:

R

which is the trivial case of the library read command. In this case, the entire transferred set of lines is read into the memory buffer. Note that the X command does not remove the transferred lines from the memory buffer, although a K command can be used directly after the X, and the R command does not empty the transferred line file. That is, given that a set of lines has been transferred with the X command, they can be re-read any number of times back into the source file. The command

ØX

is provided, however, to empty the transferred line file.

Note that upon normal completion of the ED program through Q or E, the temporary LIB file is removed. If ED is aborted through ctl-C, the LIB file will exist if lines have been transferred, but will generally be empty (a subsequent ED invocation will erase the temporary file).

Due to common typographical errors, ED 1.4 requires several potentially disastrous commands to be typed as single letters, rather than in composite commands. The commands

E (end), H (head), O (original), Q (quit)

must be typed as single letter commands.

ED 1.4 also prints error messages in the form

BREAK "x" AT c

where x is the error character, and c is the command where the error occurred.





