

FCC Compliance Statement:

<p>DECLARATION OF CONFORMITY Per FCC Part 2 Section 2.107(a)</p> <p>FC</p> <p>Responsible Party Name: G.B.T. INC.</p> <p>Address: 18316 Valley Blvd., Suite#A LA Puente, CA 91744</p> <p>Phone/Fax No: (818) 854-9338 / (818) 854-9339</p> <p>hereby declares that the product</p> <p>Product Name: Mother Board</p> <p>Model Number: GA-7IXE</p> <p>Conforms to the following specifications:</p> <p>FCC Part 15, Subpart B, Section 15.107(a) and Section 15.109(a), Class B Digital Device.</p> <p>Supplementary Information:</p> <p>This device complies with part 15 of the FCC Rules. Operation is subject to the following two conditions: (1) This device may not cause harmful and (2) this device must accept any interference received, including that may cause undesired operation.</p> <p>Representative Person's Name: <u>ERIC LU</u></p> <p>Signature: <u><i>Erik Lu</i></u></p> <p>Date: <u>Jan. 12, 2000</u></p>

This equipment has been tested and found to comply with limits for a Class B digital device, pursuant to Part 15 of the FCC rules. These limits are designed to provide reasonable protection against harmful interference in residential installations. This equipment generates, uses, and can radiate radio frequency energy, and if not installed and used in accordance with the instructions, may cause harmful interference to radio communications. However, there is no guarantee that interference will not occur in a particular installation. If this equipment does cause interference to radio or television equipment

reception, which can be determined by turning the equipment off and on, the user is encouraged to try to correct the interference by one or more of the following measures:

- Reorient or relocate the receiving antenna
- Move the equipment away from the receiver
- Plug the equipment into an outlet on a circuit different from that to which the receiver is connected
- Consult the dealer or an experienced radio/television technician for additional suggestions

You are cautioned that any change or modifications to the equipment not expressly approve by the party responsible for compliance could void Your authority to operate such equipment.

This device complies with Part 15 of the FCC Rules. Operation is subjected to the following two conditions 1) this device may not cause harmful interference and 2) this device must accept any interference received, including interference that may cause undesired operation.

Declaration of Conformity

We, Manufacturer/Importer
(full address)

G.B.T. Technology Trading GmbH
Ausschlagler Weg 41, 1F, 20537 Hamburg, Germany

declare that the product
(description of the apparatus, system, installation to which it refers)

Mother Board
GA-7IXE

is in conformity with
(reference to the specification under which conformity is declared)
in accordance with 89/336 EEC-EMC Directive

- | | | | |
|---|--|--|--|
| <input type="checkbox"/> EN 55011 | Limits and methods of measurement of radio disturbance characteristics of industrial, scientific and medical (ISM high frequency equipment | <input checked="" type="checkbox"/> EN 61000-3-2*
<input checked="" type="checkbox"/> EN60555-2 | Disturbances in supply systems caused by household appliances and similar electrical equipment "Harmonics" |
| <input type="checkbox"/> EN55013 | Limits and methods of measurement of radio disturbance characteristics of broadcast receivers and associated equipment | <input type="checkbox"/> EN61000-3-3*
<input checked="" type="checkbox"/> EN60555-3 | Disturbances in supply systems caused by household appliances and similar electrical equipment "Voltage fluctuations" |
| <input type="checkbox"/> EN 55014 | Limits and methods of measurement of radio disturbance characteristics of household electrical appliances, portable tools and similar electrical apparatus | <input checked="" type="checkbox"/> EN 50081-1
<input checked="" type="checkbox"/> EN 50082-1 | Generic emission standard Part 1: Residual, commercial and light industry
Generic immunity standard Part 1: Residual, commercial and light industry |
| <input type="checkbox"/> EN 55015 | Limits and methods of measurement of radio disturbance characteristics of fluorescent lamps and luminaries | <input type="checkbox"/> EN 55081-2 | Generic emission standard Part 2: Industrial environment |
| <input type="checkbox"/> EN 55020 | Immunity from radio interference of broadcast receivers and associated equipment | <input type="checkbox"/> EN 55082-2 | Generic immunity standard Part 2: Industrial environment |
| <input checked="" type="checkbox"/> EN 55022 | Limits and methods of measurement of radio disturbance characteristics of information technology equipment | <input type="checkbox"/> ENV 55104 | Immunity requirements for household appliances tools and similar apparatus |
| <input type="checkbox"/> DIN VDE 0855
<input type="checkbox"/> part 10
<input type="checkbox"/> part 12 | Cabled distribution systems; Equipment for receiving and/or distribution from sound and television signals | <input type="checkbox"/> EN 50091- 2 | EMC requirements for uninterruptible power systems (UPS) |

CE marking



(EC conformity marking)

The manufacturer also declares the conformity of above mentioned product with the actual required safety standards in accordance with LVD 73/23 EEC

- | | | | |
|-----------------------------------|---|-------------------------------------|---|
| <input type="checkbox"/> EN 60065 | Safety requirements for mains operated electronic and related apparatus for household and similar general use | <input type="checkbox"/> EN 60950 | Safety for information technology equipment including electrical business equipment |
| <input type="checkbox"/> EN 60335 | Safety of household and similar electrical appliances | <input type="checkbox"/> EN 50091-1 | General and Safety requirements for uninterruptible power systems (UPS) |

Manufacturer/Importer

Signature : Rex Lin
Name : Rex Lin

(Stamp)

Date: Jan. 12, 2000

7IXE
AMD™ Athlon AGP Motherboard

USER'S MANUAL

AMD™ Athlon Processor Motherboard
REV. 1.1 First Edition
R-11-01-000106

How This Manual Is Organized

This manual is divided into the following sections:

1) Revision List	Manual revision information
2) Item Checklist	Product item list
3) Features	Product information & specification
4) Hardware Setup	Instructions on setting up the motherboard
5) Performance & Block Diagram	Product Performance & Block Diagram
6) BIOS Setup	Instructions on setting up the BIOS software
7) Appendix	General reference

Table Of Content

Revision History	P.1
Item Checklist	P.2
Summary of Features	P.3
7IXE Motherboard Layout	P.5
Page Index for Connectors / Panel and Jumper Definition	P.6
Performance List	P.19
Block Diagram	P.20
Memory Installation	P.21
Page Index for BIOS Setup	P.22
Appendix	P.55

Revision History

Revision	Revision Note	Date
1.1	Initial release of the 7IXE motherboard user's manual.	Jan.2000

The author assumes no responsibility for any errors or omissions that may appear in this document nor does the author make a commitment to update the information contained herein. Third-party brands and names are the property of their respective owners.

Item Checklist

- The 71XE Motherboard
- Cable for IDE / Floppy device
- Diskettes or CD (TUCD) for motherboard utilities
- Internal COM2 Cable (Optional)
- Internal USB Cable (Optional)
- Cable for SCSI device
- 71XE User's Manual

Summary Of Features

Form factor	<ul style="list-style-type: none"> • 26 cm x 18 cm ATX SIZE form factor, 4 layers PCB.
CPU	<ul style="list-style-type: none"> • AMD Athlon(K7) Slot A Processor • 512 KB 2nd cache in CPU Module • Supports 500MHz ~ 1GHz and faster
Chipset	<p>AMD 750 ,consisting of:</p> <ul style="list-style-type: none"> • AMD 751 PCI/AGP Controller(PAC) • AMD 756 PCI ISA IDE Controller
Clock Generator	<ul style="list-style-type: none"> • Supports 90 / 95 / 100 / 105 / 110 / 115MHz
Memory	<ul style="list-style-type: none"> • 3 168-pin DIMM Sockets • Supports SDRAM 16MB~768MB(Max) • Supports only 3.3V SDRAM DIMM
I/O Control	<ul style="list-style-type: none"> • Winbond 83977
Slots	<ul style="list-style-type: none"> • 1 AGP (Accelerated Graphics Port) slot <ul style="list-style-type: none"> - AGP 66 / 133 MHz 3.3V device support • 5 32-bit Master PCI Bus slots • 2 16-bit ISA Bus slots
On-Board IDE	<ul style="list-style-type: none"> • An IDE controller on the AMD 756 PCI chipset provides IDE HDD/ CD-ROM with PIO, Bus Master , Ultra DMA33/ATA 66 Operation modes • Can connect up to four IDE devices
Hardware Monitor (Optional)	<ul style="list-style-type: none"> • CPU/Power Supply/System Fan Revolution detect • CPU / Power / System Fan Control • System Voltage Detect • CPU Overheat Warning • Chassis Intrusion Detect • Display Actual Current Voltage
On-Board Peripherals	<ul style="list-style-type: none"> • 1 Floppy port supports 2 FDD with 360K, 720K,1.2M, 1.44M and 2.88M bytes • 1 Parallel port supports SPP/EPP/ECP mode • 2 Serial Ports (COMA & COMB) • 4 USB ports • 1 IrDA connector for IR
PS/2 Connector	<ul style="list-style-type: none"> • PS/2[®] Keyboard interface and PS/2[®] Mouse interface
BIOS	<ul style="list-style-type: none"> • Licensed AMI BIOS, 2M bit FLASH ROM

To be continued...

Summary of Features

Additional Features	<ul style="list-style-type: none">• Internal/External Modem Wake up• Keyboard Password Wake up• Mouse Wake up• LAN Wake up• System after AC back
---------------------	--

7IXE Motherboard Layout

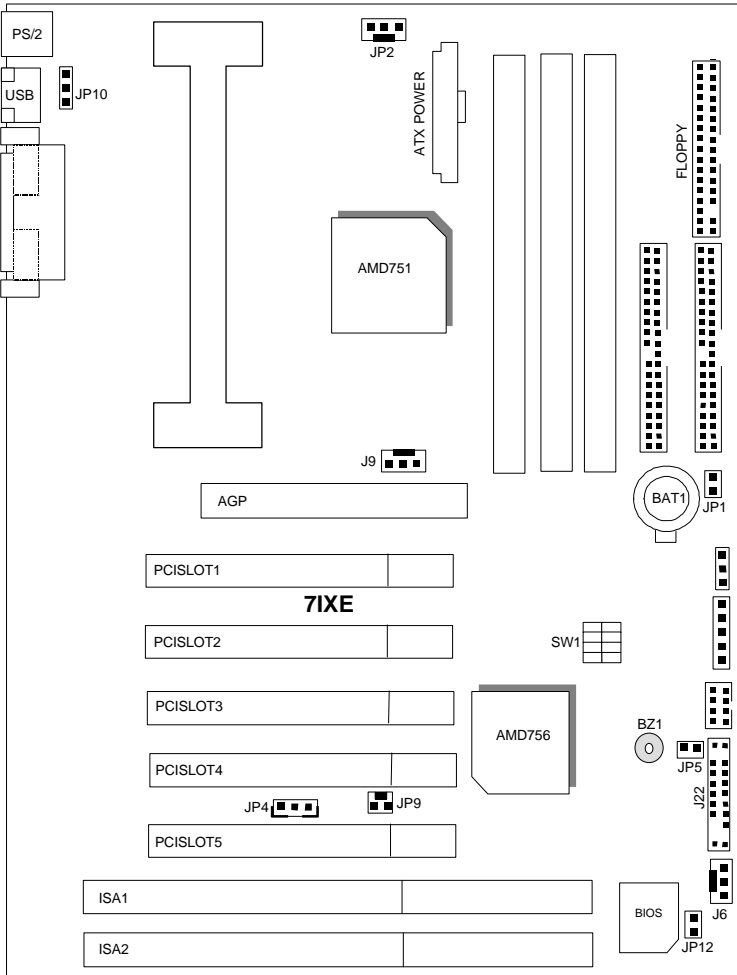

 Page Index for Connectors / Panel and Jumper Definition	Page
Connectors	P.8
COMA / COMB / LPT Port	P.8
USB Connector	P.8
PS/2 Keyboard & PS/2 Mouse Connector	P.9
Power Cooling FAN Power Connector	P.9
CPU / System Cooling FAN Power Connector	P.10
ATX Power	P.11
Floppy Port	P.11
IDE 1(Primary) / IDE 2(Secondary) Port	P.12
USB Port	P.12
IR (Optional)	P.13
JP9 (Ring Power On)	P.13
JP4 (Wake On LAN)	P.14
Panel and Jumper Definition	P.15
J22 (2x11 pins jumper)	P.15
JP10 (PS/2 Keyboard Power On)	P.16
JP1 (Case Open)	P.16
JP12 (BIOS Flash ROM Write Protection)	P.17
JP5 (Internal Buzzer Connector)[Optional]	P.17
JP3 (Clear CMOS)	P.18
BAT 1	P.18

CPU Speed Setup

The system bus frequency can be switched at 90MHz, 95MHz, 100MHz, 105MHz, 110MHz and 115MHz by adjusting SW1 (See Figure 1). The CPU Frequency is control by BIOS.

The CPU speed must match with the frequency RATIO. It will cause system hanging up if the frequency RATIO is higher than that of CPU.

SW1: CPU Speed Setup

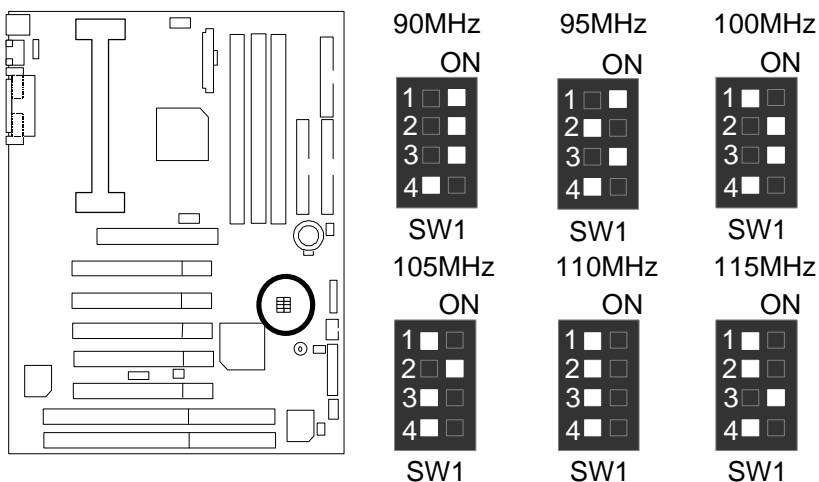
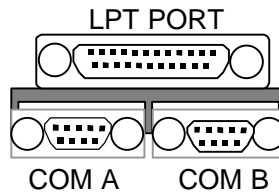
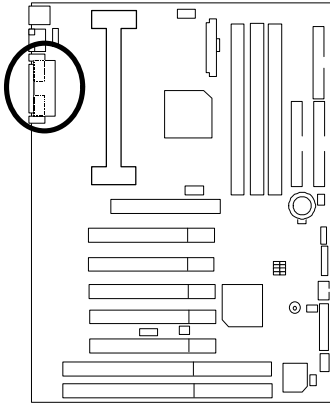

Figure 1

Note: Please set the CPU host frequency in accordance with your processor's specifications. We don't recommend you to set the system bus frequency over the CPU's specification because these specific bus frequencies are not the standard specifications for CPU, chipset and most of the peripherals. Whether your system can run under these specific bus frequencies properly will depend on your hardware configurations, including CPU, Chipsets, SDRAM, Cards....etc.

Connectors

COM A / COM B / LPT Port



USB Connector

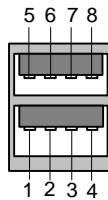
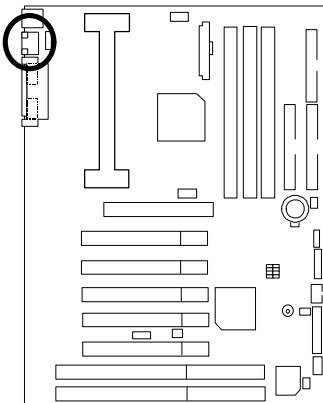

Pin No.	Definition
1	USB V0
2	USB D0-
3	USB D0+
4	GND
5	USB V1
6	USB D1-
7	USB D1+
8	GND

PS/2 Keyboard & PS/2 Mouse Connector

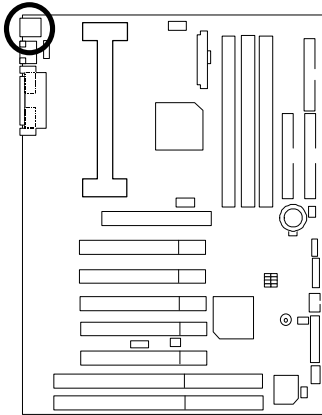

PS/2 Mouse

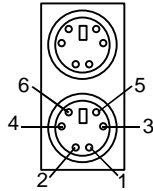

PS/2 Keyboard

PS/2 Mouse/ Keyboard	
Pin No.	Definition
1	Data
2	NC
3	GND
4	VCC(+5V)
5	Clock
6	NC

Power Cooling FAN Power Connector

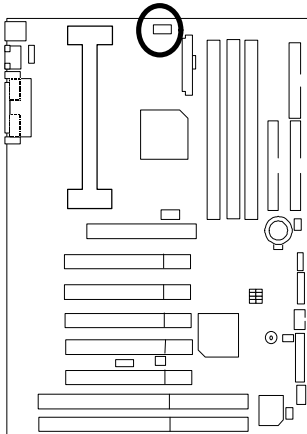

Pin No.	Definition
1	GND
2	+12V
3	SENSE

CPU Cooling FAN Power Connector

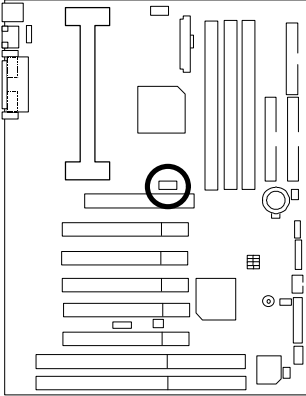

Pin No.	Definition
1	GND
2	+12V
3	SENSE

System Cooling FAN Power Connector

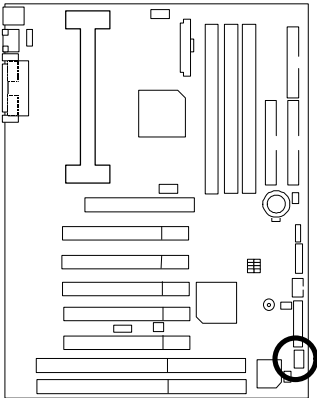

Pin No.	Definition
1	GND
2	+12V
3	SENSE

ATX Power

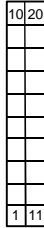
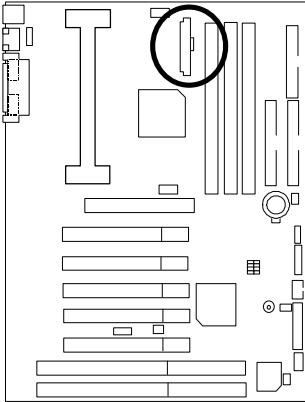

Pin No.	Definition
3,5,7,13,15-17	GND
1,2,11	3.3V
4,6,19,20	VCC
10	+12V
12	-12V
18	-5V
8	Power Good
9	5V SB stand by+5V
14	PS-ON(Soft On/Off)

Floppy Port

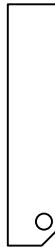
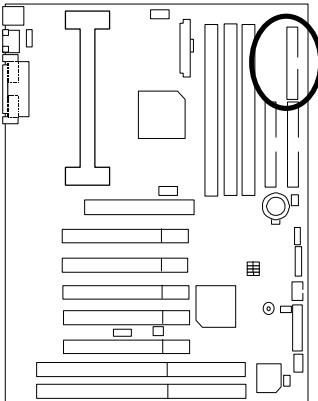

RED LINE

IDE1(Primary) , IDE2 (Secondary) Port

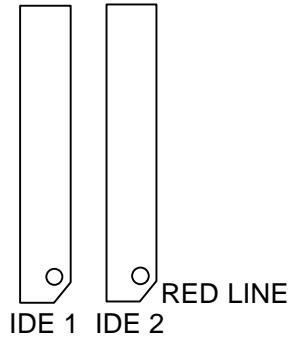
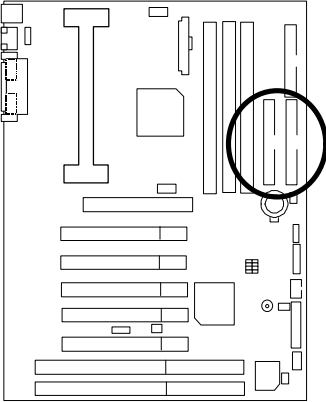

USB Port

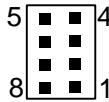
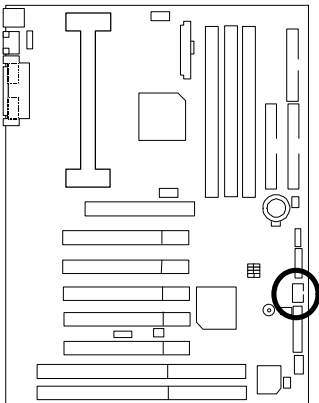

Pin No.	Definition
1	VCC
2	USB D0-
3	USB D0+
4	GND
5	VCC
6	USB D1-
7	USB D1+
8	GND

IR: Infrared Connector (Optional)

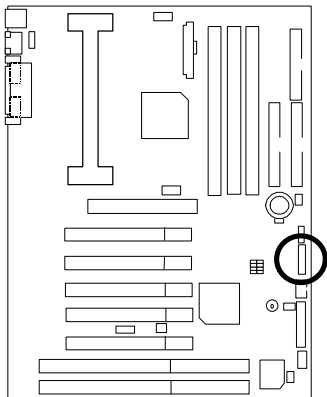

1

Pin No.	Definition
1	VCC(+5V)
2	NC
3	IR Data Input
4	GND
5	IR Data Output

JP9: Ring Power On (Internal Modem Card Wake Up)

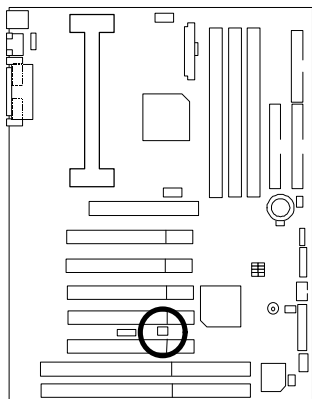

Pin No.	Definition
1	Signal
2	GND

JP4: Wake On LAN

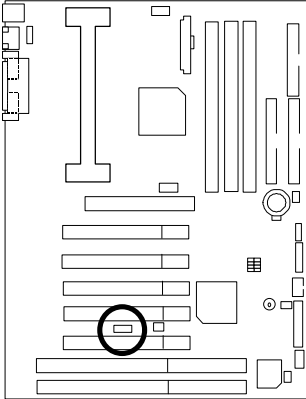

Pin No.	Definition
1	+5VSB
2	GND
3	Signal

Panel And Jumper Definition

J22: For 2X11 Pins Jumper

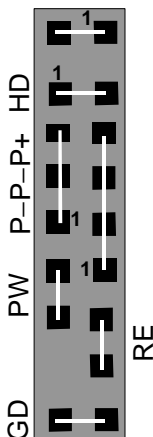
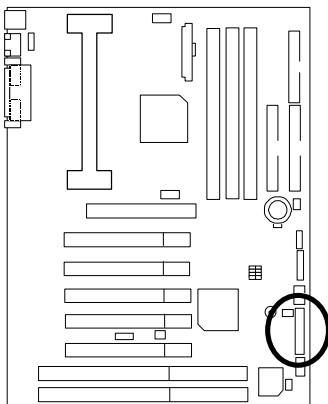

GN (Green Switch)	Open: Normal Operation Close: Entering Green Mode
GD (Green LED)	Pin 1: LED anode(+) Pin 2: LED cathode(-)
HD (IDE Hard Disk Active LED)	Pin 1: LED anode(+) Pin 2: LED cathode(-)
SPK (Speaker Connector)	Pin 1: VCC(+) Pin 2- Pin 3: NC Pin 4: Data(-)
RE (Reset Switch)	Open: Normal Operation Close: Reset Hardware System
P+P-P-(Power LED)	Pin 1: LED anode(+) Pin 2: LED cathode(-) Pin 3: LED cathode(-)
PW (Soft Power Connector)	Open: Normal Operation Close: Power On/Off

JP10: PS/2 Keyboard Power On

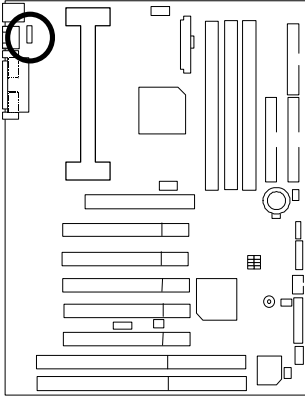

Pin No.	Definition
1-2 close	PS/2 Keyboard Power on Enabled
2-3 close	PS/2 Keyboard Power on Disabled (Default)

JP1: Case Open

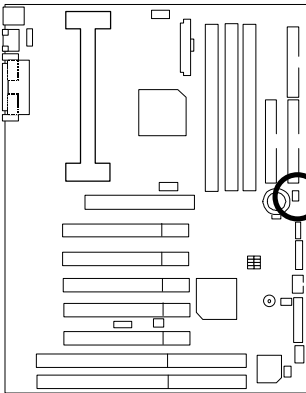

Pin No.	Definition
1	Signal
2	GND

JP12: BIOS Flash ROM Write Protection

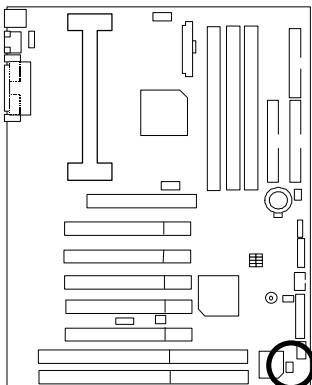

Pin No.	Definition
Close	Write Protection
Open	Normal (Default)

Please set Jumper JP12 to "Open" to enabled BIOS write function when you update new BIOS or new device.

JP5: Internal Buzzer Connector (Optional)

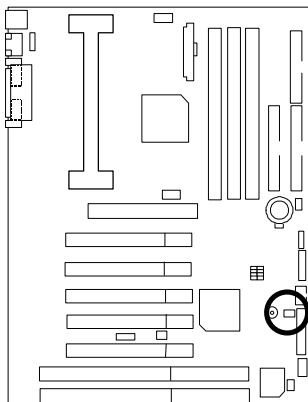

Pin No.	Definition
Close	Onboard speaker Enabled
Open	Onboard speaker Disabled

JP3: Clear CMOS

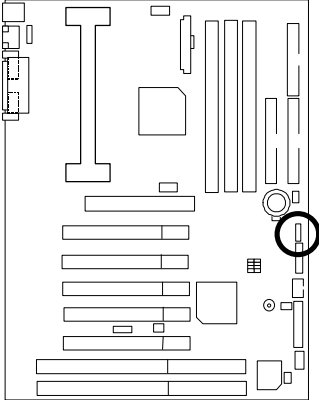

Pin No.	Definition
1-2 close	Clear CMOS (User had to short 1-2 till boot)
2-3 close	Normal (Default)

BAT1: Battery

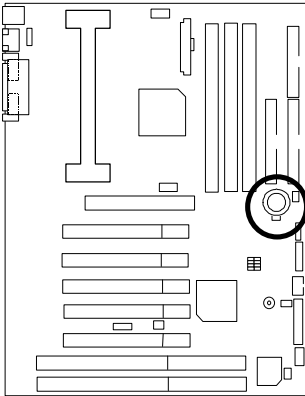

- ⚠ Danger of explosion if battery is incorrectly replaced.
- ⚠ Replace only with the same or equivalent type recommended by the manufacturer.
- ⚠ Dispose of used batteries according to the manufacturer's instructions.

7IXE Motherboard

Performance List

The following performance data list is the testing results of some popular benchmark testing programs.

These data are just referred by users, and there is no responsibility for different testing data values gotten by users. (The different Hardware & Software configuration will result in different benchmark testing results.)

- CPU AMD Athlon 750MHz processor
- DRAM (128x1)MB SDRAM (Hyundai Hy57V1298020 TC-75)
- CACHE SIZE 512 KB included in CPU
- DISPLAY GA-660 32D (32MB)
- STORAGE Onboard IDE (Quantum KA13600AT)
- O.S. Windows NT™ 4.0 SPK5
- DRIVER Display Driver at 1024 x 768 x 16bit colors x 75Hz.
- BUS TUCD 1.3
MASTER

Processor	AMD Athlon
	750MHz(100x7.5)
Winbench99	
CPU mark99	65.2
FPU Winmark 99	4150
Business Disk Winmark 99	5950
Hi-End Disk Winmark 99	13800
Business Graphics Winmark 99	363
Hi-End Graphics Winmark 99	697
Winstone99	
Business Winstone99	41.4
Hi-End Winstone99	38.4

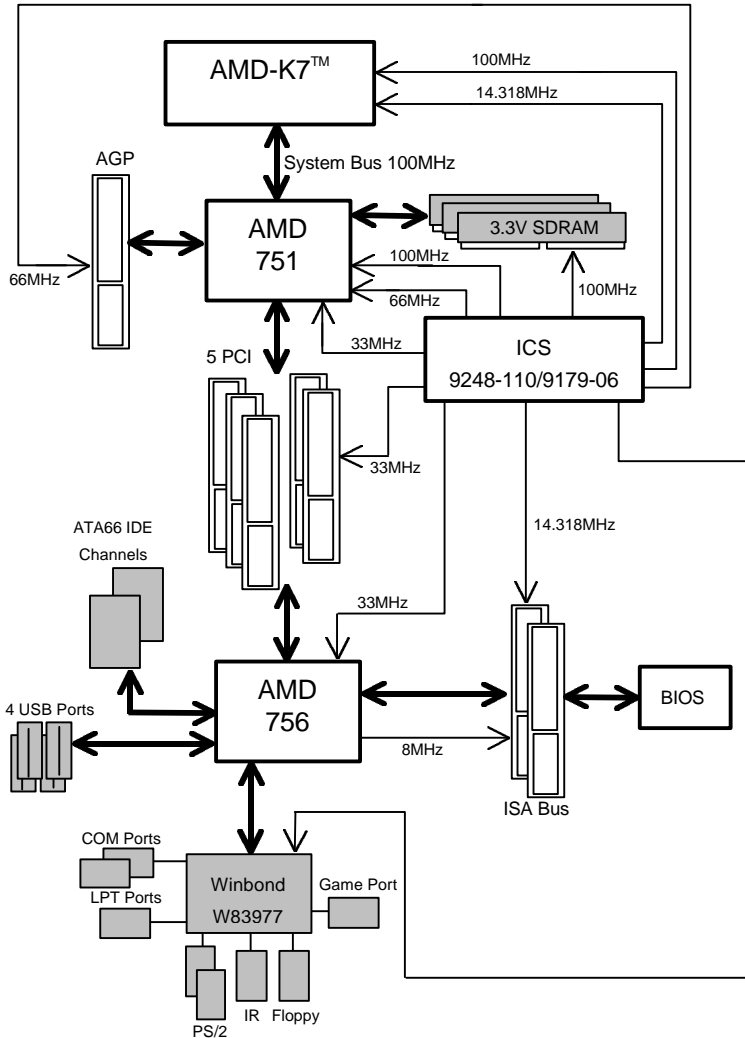
Block Diagram

Memory Installation

The motherboard has 3 dual inline memory module (DIMM) sockets. The BIOS will automatically detects memory type and size. To install the memory module, just push it vertically into the DIMM Slot .The DIMM module can only fit in one direction due to the two notch. Memory size can vary between sockets.

Install memory in any combination table:

DIMM	168-pin SDRAM DIMM Modules	
DIMM1	Supports 16 / 32 / 64 / 128 / 256 MB	X 1 pcs
DIMM2	Supports 16 / 32 / 64 / 128 / 256 MB	X 1 pcs
DIMM3	Supports 16 / 32 / 64 / 128 / 256 MB	X 1 pcs

 Page Index for BIOS Setup	Page
The Main Menu	P.24
Standard CMOS Features	P.27
BIOS Features Setup	P.30
Chipset Features Setup	P.33
Power Management Setup	P.37
PNP/ PCI Configuration	P.41
Load BIOS Defaults	P.43
Load Setup Defaults	P.44
Integrated Peripherals	P.45
PC Health status	P.48
Set Supervisor / User Password	P.51
IDE HDD Auto Detection	P.52
Save & Exit Setup	P.53
Exit Without Saving	P.54

BIOS Setup

BIOS Setup is an overview of the BIOS Setup Program. The program that allows users to modify the basic system configuration. This type of information is stored in battery-backed CMOS RAM so that it retains the Setup information when the power is turned off.

ENTERING SETUP

Power On the computer and press immediately will allow you to enter Setup. If the message disappears before you respond and you still wish to enter Setup, restart the system to try again by turning it OFF then ON or pressing the "RESET" bottom on the system case. You may also restart by simultaneously press <Ctrl> – <Alt>– keys.

CONTROL KEYS

<↑>	Move to previous item
<↓>	Move to next item
<<←>	Move to the item in the left hand
<→>	Move to the item in the right hand
<Esc>	Main Menu - Quit and not save changes into CMOS Status Page Setup Menu and Option Page Setup Menu - Exit current page and return to Main Menu
<+/ PgUp>	Increase the numeric value or make changes
<-/ PgDn>	Decrease the numeric value or make changes
<F1>	General help, only for Status Page Setup Menu and Option Page Setup Menu
<F2>	Reserved
<F3>	Reserved
<F4>	Reserved
<F5>	Restore the previous CMOS value from CMOS, only for Option Page Setup Menu
<F6>	Load the default CMOS value from BIOS default table, only for Option Page Setup Menu
<F7>	Load the Optimized Defaults.
<F8>	Reserved
<F9>	Reserved
<F10>	Save all the CMOS changes, only for Main Menu

GETTING HELP

Main Menu

The on-line description of the highlighted setup function is displayed at the bottom of the screen.

Status Page Setup Menu / Option Page Setup Menu

Press F1 to pop up a small help window that describes the appropriate keys to use and the possible selections for the highlighted item. To exit the Help Window press <Esc>.

The Main Menu

Once you enter AMI BIOS CMOS Setup Utility, the Main Menu (Figure 2) will appear on the screen. The Main Menu allows you to select from nine setup functions and two exit choices. Use arrow keys to select among the items and press <Enter> to accept or enter the sub-menu.

AMIBIOS SIMPLE SETUP UTILITY – VERSION 1.20 (C) 1998 American Megatrends, Inc. All Rights Reserved	
STANDARD CMOS SETUP	INTEGRATED PERIPHERALS
BIOS FEATURES SETUP	PC HEALTH STATUS
CHIPSET FEATURES SETUP	SUPERVISOR PASSWORD
POWER MANAGEMENT SETUP	USER PASSWORD
PNP / PCI CONFIGURATION	IDE HDD AUTO DETECTION
LOAD BIOS DEFAULTS	SAVE & EXIT SETUP
LOAD SETUP DEFAULTS	EXIT WITHOUT SAVING
ESC: Quit ↑↓→← : Select Item (Shift)F2 : Change Color F5: Old Values F6: Load BIOS Defaults F7: Load Setup Defaults F10: Save & Exit	
Time, Date , Hard Disk Type...	

Figure 2: Main Menu

- **Standard CMOS Setup**

This setup page includes all the items in standard compatible BIOS.

- **BIOS Features Setup**

This setup page includes all the items of AMI special enhanced features.

- **Chipset Features Setup**

This setup page includes all the items of chipset special features.

- **Power Management Setup**

This setup page includes all the items of Green function features.

- **PnP/PCI Configuration**

This setup page includes all the configurations of PCI & PnP ISA resources.

- **Load BIOS Defaults**

BIOS Defaults indicates the value of the system parameters which the system would be in safe configuration.

- **Load Setup Defaults**

Setup Defaults indicates the value of the system parameters which the system would be in best performance configuration.

- **Integrated Peripherals**

This setup page includes all onboard peripherals.

- **PC Health Status**

This setup page is the System auto detect Temperature, voltage , fan, speed.

- **Supervisor password**

Change, set, or disable password. It allows you to limit access to the system and Setup, or just to Setup.

- **User password**

Change, set, or disable password. It allows you to limit access to the system.

- **IDE HDD auto detection**

Automatically configure hard disk parameters.

- **Save & Exit Setup**

Save CMOS value settings to CMOS and exit setup.

- **Exit Without Saving**

Abandon all CMOS value changes and exit setup.

Standard CMOS Setup

The items in Standard CMOS Setup Menu (Figure 3) are divided into 10 categories. Each category includes no, one or more than one setup items. Use the arrows to highlight the item and then use the <PgUp> or <PgDn> keys to select the value you want in each item.

AMIBIOS SETUP – STANDARD CMOS SETUP	
(C) 1998 American Megatrends, Inc. All Rights Reserved	
Date (mm/dd/yyyy) : Mon, Sep 06, 1999	
Time (hh/mm/ss) : 04:05:37	
TYPE SIZE CYLS HEAD PRECOMP LANDZ SECTOR MODE	
Pri Master	Auto
Pri Slave	Auto
Sec Master	Auto
Sec Slave	Auto
Floppy Drive A : 1.44 MB 3½	Base Memory : 640 Kb
Floppy Drive B : Not Installed	Other Memory : 384 Kb
	Extended Memory : 63 Mb
	Total Memory : 64 Mb
Boot Sector Virus Protection : Disabled	
Month : Jan – Dec	ESC : Exit
Day : 01– 31	↑↓ : Select Item
Year : 1901 – 2099	PU / PD / + / - : Modify
	(Shift) F2 : Color

Figure 3: Standard CMOS Setup

- **Date**

The date format is <week>, <month> <day> <year>.

week	The week, from Sun to Sat, determined by the BIOS and is display-only
month	The month, Jan. Through Dec.
day	The day, from 1 to 31 (or the maximum allowed in the month)
year	The year, from 1994 through 2079

- **Time**

The times format in <hour> <minute> <second>. The time is calculated base on the 24-hour military-time clock. For example, 1 p.m. is 13:00:00.

- **Primary Master, Slave / Secondary Master, Slave**

The category identifies the types of hard disk from drive C to F that has been installed in the computer. There are two types: auto type, and user definable type. User type is user-definable; Auto type which will automatically detect HDD type.

Note that the specifications of your drive must match with the drive table. The hard disk will not work properly if you enter improper information for this category.

If you select User Type, related information will be asked to enter to the following items. Enter the information directly from the keyboard and press <Enter>. Such information should be provided in the documentation form your hard disk vendor or the system manufacturer.

CYLS.	Number of cylinders
HEADS	number of heads
PRECOMP	write precomp
LANDZONE	Landing zone
SECTORS	number of sectors

If a hard disk has not been installed select NONE and press <Enter>.

- **Floppy Drive A type / Drive B**

The category identifies the types of floppy disk drive A or drive B that has been installed in the computer.

None	No floppy drive installed
360K, 5.25 in.	5.25 inch PC-type standard drive; 360K byte capacity.
1.2M, 5.25 in.	5.25 inch AT-type high-density drive; 1.2M byte capacity (3.5 inch when 3 Mode is Enabled).
720K, 3.5 in.	3.5 inch double-sided drive; 720K byte capacity
1.44M, 3.5 in.	3.5 inch double-sided drive; 1.44M byte capacity.
2.88M, 3.5 in.	3.5 inch double-sided drive; 2.88M byte capacity.

- **Boot Sector Virus Protection**

If it is set to enable, the category will flash on the screen when there is any attempt to write to the boot sector or partition table of the hard disk drive. The system will halt and the following error message will appear in the mean time. You can run anti-virus program to locate the problem.

Enabled	Activate automatically when the system boots up causing a warning message to appear when anything attempts to access the boot sector or hard disk partition table
Disabled	No warning message to appear when anything attempts to access the boot sector or hard disk partition table (Default Value)

- **Memory**

The category is display-only which is determined by POST (Power On Self Test) of the BIOS.

Base Memory

The POST of the BIOS will determine the amount of base (or conventional) memory installed in the system.

The value of the base memory is typically 512 K for systems with 512 K memory installed on the motherboard, or 640 K for systems with 640 K or more memory installed on the motherboard.

Other Memory

This refers to the memory located in the 640 K to 1024 K address space. This is memory that can be used for different applications.

DOS uses this area to load device drivers to keep as much base memory free for application programs. Most use for this area is Shadow RAM.

Extended Memory

The BIOS determines how much extended memory is present during the POST.

This is the amount of memory located above 1 MB in the CPU's memory address map.

BIOS Features Setup

AMIBIOS SETUP – BIOS FEATURES SETUP		
(C) 1998 American Megatrends, Inc. All Rights Reserved		
Quick Boot	Enabled	
1st Boot Device	Floppy	
2nd Boot Device	IDE-0	
3rd Boot Device	CDROM	
Try Other Boot Devices	Yes	
Floppy Access Control	Read-Write	
Hard Disk Access Control	Read-Write	
BootUp Num-Lock	On	
Floppy Drive Swap	Disabled	
Floppy Drive Seek	Disabled	
Security Option	Setup	
Boot To OS/2 > 64MB	No	
BIOS Write Protect	Disabled	
C000, 32K Shadow	Cached	
C800, 16K Shadow	Disabled	
CC00, 16K Shadow	Disabled	ESC: Quit ↑↓→←: Select Item
D000, 16K Shadow	Disabled	F1 : Help PU/PD+/-: Modify
D400, 16K Shadow	Disabled	F5 :Old Values(Shift)F2:Color
D800, 16K Shadow	Disabled	F6 : Load BIOS Defaults
DC00, 16K Shadow	Disabled	F7 : Load Setup Defaults

Figure 4: BIOS Features Setup

- **Quick Boot**

Enabled	Enabled Quick Boot Function. (Default Value)
Disabled	Disabled Quick Boot Function.

- **1st / 2nd / 3rd Boot Device**

Floppy	Boot Device by Floppy.
LS/ZIP A:	Boot Device by LS/ZIP A:.
CDROM	Boot Device by CDROM.
SCSI	Boot Device by SCSI.
NETWORK	Boot Device by NETWORK.
IDE-0-IDE-3	Boot Device by IDE-0-IDE-3.
Disabled	Boot Device by Disabled.
ATAPI ZIP C:	Boot Device by ATAPI ZIP C:.

- **Try Other Boot Device**

Yes	Enabled other device to boot system. (Default Value)
No	Disabled other device to boot system.

- **Floppy Access Control**

Read-Write	Set Floppy Access Control : Read-Write. (Default Value)
Read-Only	Set Floppy Access Control : Read Only.

- **Hard Disk Access Control**

Read-Write	Set Hard Disk Access Control : Read-Write. (Default Value)
Read-Only	Set Hard Disk Access Control : Read Only.

- **Boot Up Num-Lock**

On	Keypad is number keys. (Default Value)
Off	Keypad is arrow keys.

- **Floppy Drive Swap**

Enabled	Floppy A & B will be swapped under DOS
Disabled	Floppy A & B will be normal definition (Default Value) .

- **Floppy Drive Seek**

During POST, BIOS will determine if the floppy disk drive installed is 40 or 80 tracks. 360 type is 40 tracks while 720 , 1.2 and 1.44 are all 80 tracks.

Enabled	BIOS searches for floppy disk drive to determine if it is 40 or 80 tracks. Note that BIOS can not tell from 720, 1.2 or 1.44 drive type as they are all 80 tracks.
Disabled	BIOS will not search for the type of floppy disk drive by track number. Note that there will not be any warning message if the drive installed is 360. (Default Value)

- **Security Option**

This category allows you to limit access to the Always and Setup, or just to Setup.

Always	The system can not boot and can not access to Setup page will be denied if the correct password is not entered at the prompt.
Setup	The system will boot, but access to Setup will be denied if the correct password is not entered at the prompt. (Default value)

- **Boot To OS/2 > 64MB**

Yes	Enabled Boot To OS/2.
No	Disabled Boot To OS/2. (Default Value)

- **BIOS Write Protect**

Enabled	Enabled BIOS Write Protect function.
Disabled	Disabled this function. (Default Value)

- **C000 32K Shadow- DC00 16K Shadow**

These categories determine whether optional ROM will be copied to RAM by 16 byte.

Enabled	Optional shadow is enabled.
Disabled	Optional shadow is disabled.
Cached	Optional shadow is cached.

Chipset Features Setup

AMIBIOS SETUP – CHIPSET FEATURES SETUP (C) 1998 American Megatrends, Inc. All Rights Reserved	
**** SDRAM Timing ****	
Config SDRAM Timing	Auto
*SDRAM PH Limit	32 Cycles
*SDRAM Idle Cycle Limit	8 Cycles
*SDRAM TRC Bank Cycle Time	7 Cycles
*SDRAM TRP SRAS Precharge	2 Cycles
*SDRAM TRAS Timing	5 Cycles
*SDRAM CAS Latency	2 Cycles
*SDRAM TRCD Timing	2 Cycles
DRAM Integrity Mode	Disabled
Memory Hole	Disabled
DRAM Burst Refresh	Enabled
Graphics Aperture Size	64MB
USB Function	Enabled
USB KB Legacy Support	Disabled
ESC: Quit ↑↓→←: Select Item F1 : Help PU/PD+/-: Modify F5 :Old Values(Shift)F2:Color F6 : Load BIOS Defaults F7 : Load Setup Defaults	

Figure 5: Chipset Features Setup

*These seven items will be available when Config SDRAM Timing is set to Manual.

- **Config SDRAM Timing**

Auto	Set Config SDRAM Timing to Auto. (Default value)
Manual	Set Config SDRAM Timing to Manual.

- **SDRAM PH Limit**

This function specify the number of consecutive Page-Hit requests to allow before choosing a non-Page-Hit request.

1 Cycles	Set SDRAM PH Limit to 1 Cycles.
4 Cycles	Set SDRAM PH Limit to 4 Cycles.
32 Cycles	Set SDRAM PH Limit to 32 Cycles. (Default value)
64 Cycles	Set SDRAM PH Limit to 64 Cycles.

- **SDRAM Idle Cycle Limit**

This function specify the number of idle cycles to wait before precharging an idle bank. (Idle cycles are defined as cycles where no valid request is asserted to the MCT.)

0 Cycles	Set SDRAM Idle Limit to 0 Cycles.
8 Cycles	Set SDRAM Idle Limit to 8 Cycles. (Default value)
12 Cycles	Set SDRAM Idle Limit to 12 Cycles.
16 Cycles	Set SDRAM Idle Limit to 16 Cycles.
24 Cycles	Set SDRAM Idle Limit to 24 Cycles.
32 Cycles	Set SDRAM Idle Limit to 32 Cycles.
48 Cycles	Set SDRAM Idle Limit to 48 Cycles.
Disabled	Disabled this function.

- **SDRAM TRC Bank Cycle Time**

This function specify the minimum time from activate to activate of the same bank.

3 Cycles	Set SDRAM TRC Timing Value to 3 Cycles.
4 Cycles	Set SDRAM TRC Timing Value to 4 Cycles.
5 Cycles	Set SDRAM TRC Timing Value to 5 Cycles.
6 Cycles	Set SDRAM TRC Timing Value to 6 Cycles.
7 Cycles	Set SDRAM TRC Timing Value to 7 Cycles. (Default value)
8 Cycles	Set SDRAM TRC Timing Value to 8 Cycles.

- **SDRAM TRP SRAS Precharge**

This function specify the delay from precharge command to activate command.

2 Cycle	Set SDRAM TRP Timing Value to 2 Cycle. (Default value)
3 Cycle	Set SDRAM TRP Timing Value to 3 Cycle.

- **SDRAM TRAS Timing**

This function specify the minimum bank (SRAS[2:0]#) active time.

2 Cycles	Set SDRAM TRAS Timing Value to 2 Cycles.
3 Cycles	Set SDRAM TRAS Timing Value to 3 Cycles.
4 Cycles	Set SDRAM TRAS Timing Value to 4 Cycles.
5 Cycles	Set SDRAM TRAS Timing Value to 5 Cycles. (Default value)
6 Cycles	Set SDRAM TRAS Timing Value to 6 Cycles.
7 Cycles	Set SDRAM TRAS Timing Value to 7 Cycles.

- **SDRAM CAS Latency**

This function specify the delay from SCAS[2:0]# to data valid.

2 Cycles	Set SDRAM CAS Latency to 2 Cycles. (Default value)
3 Cycles	Set SDRAM CAS Latency to 3 Cycles.
4 Cycles	Set SDRAM CAS Latency to 4 Cycles.

- **SDRAM TRCD Timing**

This function specify the delay from the activation of a bank to the time that a read or write command is accepted.

1 Cycle	Set SDRAM TRCD Timing Value to 1 Cycle.
2 Cycle	Set SDRAM TRCD Timing Value to 2 Cycle. (Default value)
3 Cycle	Set SDRAM TRCD Timing Value to 3 Cycle.
4 Cycle	Set SDRAM TRCD Timing Value to 4 Cycle.

- **DRAM Integrity Mode**

Disabled	Disabled this function. (Default Value)
ECC	Set DRAM Integrity Mode to ECC.

- **Memory Hole**

Disabled	Normal Setting. (Default Value)
14MB-15MB	Set Address=14~15MB remap to ISA BUS.
15MB-16MB	Set Address=15~16MB remap to ISA BUS.
14MB-16MB	Set Address=14~16MB remap to ISA BUS.

- **DRAM Burst Refresh**

Disabled	Disabled this function.
Enabled	Enabled DRAM Burst Refresh function. (Default Value)

- **Graphics Aperture Size**

32 MB	Display Graphics Aperture Size is 32MB.
64 MB	Display Graphics Aperture Size is 64MB. (Default Value)
128 MB	Display Graphics Aperture Size is 128MB.
256 MB	Display Graphics Aperture Size is 256MB.
512 MB	Display Graphics Aperture Size is 512MB.
1 GB	Display Graphics Aperture Size is 1GB.
2 GB	Display Graphics Aperture Size is 2GB.

- **USB Function**

Disabled	Disabled USB Function.
Enabled	Enabled USB Function. (Default Value)

- **USB KB Legacy Support**

Disabled	Disable USB KB Legacy Support. (Default Value)
Keyboard	Set USB KB Legacy Support to Keyboard.
Keyb+Mouse	Set USB KB Legacy Support to Keyb+Mouse.

Power Management Setup

AMBIOS SETUP – POWER MANAGEMENT SETUP (C) 1998 American Megatrends, Inc. All Rights Reserved			
Power Management/APM	Enabled	PME Event Wake Up	Disabled
Video Power Down Mode	Suspend	Resume by Alarm	Disabled
Hard Disk Power Down Mode	Suspend	Data (of Month) Alarm	15
Standby Time Out (Minute)	Disabled	Hour Alarm	12
Suspend Time Out (Minute)	Disabled	Minute Alarm	30
Display Activity	Ignore	Second Alarm	30
IRQ3	Both	Keyboard PowerOn Function	Disabled
IRQ4	Both	Password for PowerOn	N/A
IRQ5	Ignore	Mouse PowerOn function	Disabled
IRQ7	Both		
IRQ9	Both		
IRQ10	Both		
IRQ11	Both		
IRQ13	Both		
IRQ14	Both		
IRQ15	Both		
Thermal Slow Clock Ratio	50.0%	ESC: Quit	↑↓→←: Select Item
Soft-off by Power Button	Instant Off	F1 : Help	PU/PD+/-: Modify
System after AC Back	Memory	F5 :Old Values(Shift)F2:Color	
Modem Ring On/Wake On Lan	Enabled	F6 : Load BIOS Defaults	
		F7 : Load Setup Defaults	

Figure 6: Power Management Setup

- Power Management / APM**

Enabled	Enabled Green & software APM function. (Default Value)
Disabled	Disabled Green & software APM function.

- Video Power Down Mode**

Disabled	Disabled Video Power Down Mode Function.
Suspend	Set Video Power Down Mode to Suspend. (Default Value)
Stand By	Set Video Power Down Mode to Stand By.

- Hard Disk Power Down Mode**

Disabled	Disabled Hard Disk Power Down Mode Function.
Suspend	Set Hard Disk Power Down Mode to Suspend. (Default Value)
Stand By	Set Hard Disk Power Down Mode to Stand By.

- **Standby Time Out (Minute)**

Disabled	Disabled Standby Time Out Function. (Default Value)
1	Enabled Standby Time Out after 1min.
2	Enabled Standby Time Out after 2min.
4	Enabled Standby Time Out after 4min.
8	Enabled Standby Time Out after 8min.
10	Enabled Standby Time Out after 10min.
20	Enabled Standby Time Out after 20min.
30	Enabled Standby Time Out after 30min.
40	Enabled Standby Time Out after 40min.
50	Enabled Standby Time Out after 50min.
60	Enabled Standby Time Out after 60min.

- **Suspend Time Out (Minute)**

Disabled	Disabled Suspend Time Out Function. (Default Value)
1	Enabled Suspend Time Out after 1min.
2	Enabled Suspend Time Out after 2min.
4	Enabled Suspend Time Out after 4min.
8	Enabled Suspend Time Out after 8min.
10	Enabled Suspend Time Out after 10min.
20	Enabled Suspend Time Out after 20min.
30	Enabled Suspend Time Out after 30min.
40	Enabled Suspend Time Out after 40min.
50	Enabled Suspend Time Out after 50min.
60	Enabled Suspend Time Out after 60min.

- **Display Activity**

Ignore	Set Display Activity to Ignore. (Default Value)
Monitor	Set Display Activity to Monitor.

- **IRQ[3,4,5,7,8,9,10,11,13,14,15]**

Ignore	Set IRQ to Ignore.
Both	Set IRQ to Both.
WakeUp	Set IRQ to WakeUP.
Monitor	Set IRQ to Monitor.

- **Thermal Slow Clock Ratio**

12.5%	Set Thermal Slow Clock Ratio to 12.5%.
25.0%	Set Thermal Slow Clock Ratio to 25.0%.
37.5%	Set Thermal Slow Clock Ratio to 37.5%.
50.0%	Set Thermal Slow Clock Ratio to 50.0%. (Default Value)
62.5%	Set Thermal Slow Clock Ratio to 62.5%.
75.0%	Set Thermal Slow Clock Ratio to 75.0%.
87.5%	Set Thermal Slow Clock Ratio to 87.5%.

- **Soft-off by Power Button**

Instant-off	Soft switch ON/OFF for POWER ON/OFF. (Default Value)
Delay 4 Sec.	Soft switch ON 4sec. for POWER OFF.

- **System after AC Back**

Memory	This function depends on computer status. (Default value)
Soft-Off	Set System Soft-Off Status.
Full-On	Set System Full-On Status.

- **ModemRingOn / WakeOnLan**

Disabled	Disabled these functions.
Enabled	Enabled these functions. (Default value)

- **PME Event Wake up**

Disabled	Disabled PME Event Wake up function. (Default Value)
Enabled	Enabled PME Event Wake up function.

- **Resume by Alarm**

You can set "Resume by Alarm" item to Enabled and key in date/time to power on system.

Disabled	Disable this function. (Default value)
Enabled	Enable alarm function to POWER ON system.

If the default value is Enabled.

Date (of Month) Alarm :	0-31
Hour Alarm	0-23
Minute Alarm	0-59

7IXE Motherboard

Second Alarm	0-59
--------------	------

- **Keyboard Power on**

Disabled	Disable Keyboard Power on. (Default value)
Password	Enter from 1 to 5 characters to set the Keyboard Power On Password.
Power Key	If you keyboard have "POWER Key " button, you can press the key to power on your system.

- **Password for PowerOn**

Enter	Enter from 1 to 5 characters to set the Keyboard Power On Password.
-------	---

- **Mouse Power On Function**

Disabled	Disable this function. (Default Value)
Left-button	Double click twice on PS/2 left button.
Right-button	Double click twice on PS/2 right button.

PNP/PCI Configuration

AMIBIOS SETUP – PNP / PCI CONFIGURATION (C) 1998 American Megatrends, Inc. All Rights Reserved		
PnP OS Installed	No	
Reset Configuration Data	No	
PCI Latency Timer	64	
VGA Boot from	AGP	
PCI VGA Palette Snoop	Disabled	
DMA Channel 0	PnP	
DMA Channel 1	PnP	
DMA Channel 3	PnP	
DMA Channel 5	PnP	
DMA Channel 6	PnP	
DMA Channel 7	PnP	
IRQ 3	PCI/PnP	
IRQ 4	PCI/PnP	
IRQ 5	PCI/PnP	
IRQ 7	PCI/PnP	
IRQ 9	PCI/PnP	
IRQ 10	PCI/PnP	ESC: Quit ↑↓→←: Select Item F1 : Help PU/PD+/-: Modify F5 :Old Values(Shift)F2:Color F6 : Load BIOS Defaults F7 : Load Setup Defaults
IRQ 11	PCI/PnP	
IRQ 14	PCI/PnP	
IRQ 15	PCI/PnP	
IRQ 15	PCI/PnP	

Figure 7: PNP/PCI Configuration

- PnP OS Installed**

Yes	Enable PnP OS Installed function.
No	Disable PnP OS Installed function. (Default value)

- Reset Configuration Data**

No	Disabled this function. (Default value)
Yes	Enabled Reset Configuration Data function.

- **PCI Latency Timer**

32	Set PCI Latency Timer to 32.
64	Set PCI Latency Timer to 64. (Default value)
96	Set PCI Latency Timer to 96.
128	Set PCI Latency Timer to 128.
160	Set PCI Latency Timer to 160.
192	Set PCI Latency Timer to 192.
224	Set PCI Latency Timer to 224.
248	Set PCI Latency Timer to 248.

- **VGA Boot from**

AGP	Set VGA Boot from to AGP. (Default Value)
PCI	Set VGA Boot from to PCI.

- **PCI/VGA Palette Snoop**

Enabled	For having Video Card on ISA Bus and VGA Card on PCI Bus.
Disabled	For VGA Card only. (Default Value)

- **DMA Channel(0,1,3,5,6,7)**

ISA/ EISA	The resource is used by Legacy ISA device.
PnP	The resource is used by PnP device. (Default Value)

- **IRQ (3,4,5,7,9, 10,11,14,15)**

ISA/ EISA	The resource is used by Legacy ISA device.
PCI/ PnP	The resource is used by PCI/ PnP device. (Default Value)

Load BIOS Defaults

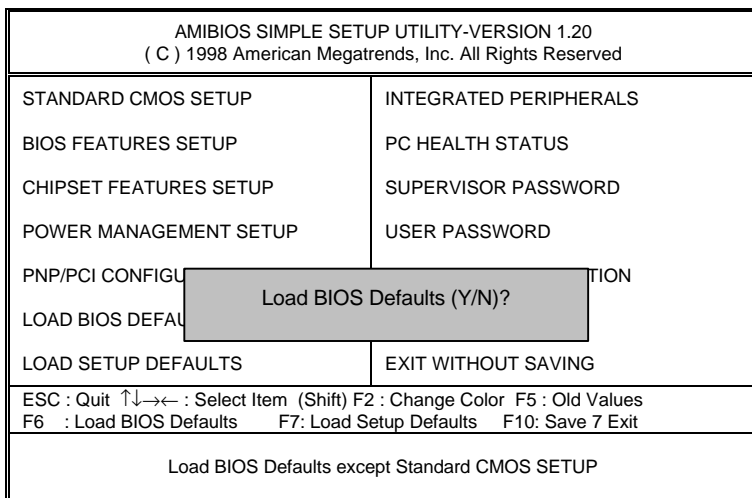

Figure 8: Load BIOS Defaults

- **LOAD BIOS DEFAULTS**

To load BIOS defaults value to CMOS, enter "Y". If not, enter "N".

Load Setup Defaults

AMIBIOS SIMPLE SETUP UTILITY-VERSION 1.20 (C) 1998 American Megatrends, Inc. All Rights Reserved	
STANDARD CMOS SETUP	INTEGRATED PERIPHERALS
BIOS FEATURES SETUP	PC HEALTH STATUS
CHIPSET FEATURES SETUP	SUPERVISOR PASSWORD
POWER MANAGEMENT SETUP	USER PASSWORD
PNP/PCI CONFIGURATION	IDE HDD AUTO DETECTION
LOAD BIOS DEFAULTS	<div style="border: 1px solid black; background-color: #cccccc; padding: 5px; width: fit-content; margin: auto;"> Load Setup Defaults (Y/N)? </div>
LOAD SETUP DEFAULTS	EXIT WITHOUT SAVING
ESC : Quit ↑↓→← : Select Item (Shift) F2 : Change Color F5 : Old Values F6 : Load BIOS Defaults F7: Load Setup Defaults F10: Save 7 Exit	
Load Setup Defaults except Standard CMOS SETUP	

Figure 9: Load SETUP Defaults

- **LOAD SETUP DEFAULTS**

To load SETUP defaults value to CMOS, enter "Y". If not, enter "N".

Integrated Peripherals

AMIBIOS SETUP – INTEGRATED PERIPHERALS	
(C) 1998 American Megatrends, Inc. All Rights Reserved	
OnBoard IDE	Both
OnBoard FDC	Auto
OnBoard Serial Port A	Auto
OnBoard Serial Port B	Auto
IR I/O Pin Select	SINB/SOUTB.
Serial PortB Mode	Normal
*IR Duplex Mode	N/A
OnBoard Parallel Port	Auto
Parallel Port Mode	SPP
**Parallel Port IRQ	Auto
# Parallel Port DMA	N/A
ESC: Quit ↑↓→←: Select Item F1 : Help PU/PD+/-/ : Modify F5 :Old Values(Shift)F2:Color F6 : Load BIOS Defaults F7 : Load Setup Defaults	

Figure 10: Integrated Peripherals

*This item will be available when "Serial PortB Mode" set to IrDA.

**This item will be available when "Onboard Parallel Port" set to 378, 278 or 3BC.

#This item will be available when "Onboard Parallel Port" set to 378, 278 and "Parallel Mode" set to ECP.

- **On Board IDE**

Disabled	Disabled OnBoard IDE.
Both	Set OnBoard IDE is Both. (Default Value)
Primary	Set OnBoard IDE is Primary.
Secondary	Set OnBoard IDE is Secondary.

- **OnBoard FDC**

Auto	Set OnBoard FDC is Auto. (Default Value)
Disabled	Disabled OnBoard FDC.
Enabled	Enabled OnBoard FDC.

- **On Board Serial Port A**

Auto	BIOS will automatically setup the port A address. (Default Value)
3F8/COM1	Enable on Board Serial port A and address is 3F8.
2F8/COM2	Enable on Board Serial port A and address is 2F8.
3E8/COM3	Enable on Board Serial port A and address is 3E8.
2E8/COM4	Enable on Board Serial port A and address is 2E8.
Disabled	Disable on Board Serial port A.

- **On Board Serial Port B**

Auto	BIOS will automatically setup the port B address. (Default Value)
3F8/COM1	Enable on Board Serial port B and address is 3F8.
2F8/COM2	Enable on Board Serial port B and address is 2F8.
3E8/COM3	Enable on Board Serial port B and address is 3E8.
2E8/COM4	Enable on Board Serial port B and address is 2E8.
Disabled	Disable on Board Serial port B.

- **IR I/O Pin Select**

SINB/SOUTB.	Set IR I/O Pin Select to SINB/SOUTB. (Default Value)
IRRX/IRTX	Set IR I/O Pin Select to IRRX/IRTX.

- **Serial PortB Mode**

(This item allows you to determine which Serial PortB Mode of onboard I/O chip)

IrDA	Set onboard I/O chip Serial PortB to IrDA Mode.
Normal	Set onboard I/O chip Serial PortB to Normal Mode. (Default Value)
ASKIR	Set onboard I/O chip Serial PortB to ASKIR Mode.

- **IR Duplex Mode**

N/A	Disabled this function. (Default Value)
Half Duplex	Set IR Duplex Mode to Half Duplex.
Full Duplex	Set IR Duplex to Full Duplex.

- **Onboard Parallel Port**

3BC	Enabled onboard LPT port and address is 3BC.
378	Enabled onboard LPT port and address is 378.
278	Enabled onboard LPT port and address is 278.
Disabled	Disabled onboard LPT port.
Auto	Set Onboard Parallel Port to Auto. (Default value)

- **Parallel Port Mode**

SPP	Using Parallel port as Standard Parallel Port. (Default value)
EPP	Using Parallel port as Enhanced Parallel Port.
ECP	Using Parallel port as Extended Capabilities Port.
Normal	Normal Operation.

- **Parallel Port IRQ**

7	Set Parallel Port IRQ is 7.
5	Set Parallel Port IRQ is 5.
Auto	Set Parallel Port IRQ is Auto. (Default Value)

- **Parallel Port DMA**

This item is set Auto when On board Parallel port set auto.

3	Set Parallel Port DMA is 3.
1	Set Parallel Port DMA is 1.
0	Set Parallel Port DMA is 0.
Auto	Set Parallel Port DMA is Auto. (Default Value)



PC Health Status

AMIBIOS SETUP – PC HEALTH STATUS			
(C) 1998 American Megatrends, Inc. All Rights Reserved			
Reset Case Open Status	No	VBAT	3.056 V
Case Open	No	5V SB	4.896 V
Slow Down CPU Duty Cycle	Normal		
Shut Down Temperature	70°C/ 158°F		
CPU Temperature	65°C/ 149°F		
Current CPU Temperature	34°C/ 93°F		
CPU Fan Fail Alarm	No		
Power Fan Fail Alarm	No		
System Fan Fail Alarm	No		
Current CPU Fan Speed	5273 RPM		
Current Power Fan Speed	0 RPM		
Current System Fan Speed	0 RPM		
Current System Temp.	29°C/ 84°F		
Vcore	2.016 V		
Vcache	1.488 V		
Vcc3	3.312 V		
+5.000V	5.030 V	ESC: Quit	↑↓→←: Select Item
+12.000V	11.923 V	F1 : Help	PU/PD+/-: Modify
-12.000V	-11.579 V	F5 :Old Values(Shift)	F2:Color
-5.000V	-4.675 V	F6 : Load BIOS Defaults	
		F7 : Load Setup Defaults	

Figure 11: PC Health Status

- **Reset Case Open Status**

- **Case Open**

If the case is closed, "Case Opened" will show "No".

If the case have been opened, "Case Opened" will show "Yes" .

If you want to reset "Case Opened" value, set "Reset Case Open Status" to "Yes" and save CMOS, your computer will restart.

- **Slow Down CPU Duty Cycle**

Normal	Normal Operation. (Default value)
12.5%~87.5%	Monitor CPU Temp. will cause system slow down CPU Duty Cycle to 12.5%~87.5%.

- **Shut Down Temperature (°C / °F)**

(This function will be effective only for the operating systems that support ACPI Function.)

Disabled	Normal Operation.
60°C / 140°F	Monitor CPU Temp. at 60°C / 140°F, if Temp. > 60°C / 140°F system will automatically power off.
65°C / 149°F	Monitor CPU Temp. at 65°C / 149°F, if Temp. > 65°C / 149°F system will automatically power off.
70°C / 158°F	Monitor CPU Temp. at 70°C / 158°F, if Temp. > 70°C / 158°F system will automatically power off. (Default value)
75°C / 167°F	Monitor CPU Temp. at 75°C / 167°F, if Temp. > 75°C / 167°F system will automatically power off.

- **CPU Temperature (°C / °F)**

65°C / 149°F	Monitor CPU Temp. at 65°C / 149°F. (Default value)
70°C / 158°F	Monitor CPU Temp. at 70°C / 158°F.
75°C / 167°F	Monitor CPU Temp. at 75°C / 167°F.
80°C / 176°F	Monitor CPU Temp. at 80°C / 176°F.
85°C / 185°F	Monitor CPU Temp. at 85°C / 185°F.
90°C / 194°F	Monitor CPU Temp. at 90°C / 194°F.
95°C / 203°F	Monitor CPU Temp. at 95°C / 203°F.
Disabled	Disabled this function.

- **Current CPU Temperature (°C / °F)**

Detect CPU Temp. automatically.

- **Fan Fail Alarm**

CPU / Power / System

No	Fan Fail Alarm Function Disabled. (Default Value)
Yes	Fan Fail Alarm Function Enabled.

- **Current FAN Speed (RPM)**

Detect Fan speed status automatically.

- **Current System Temp. (°C / °F)**

Detect System Temp. automatically.

- **Current Vcore / Vcahe / Vcc3 / ±12V / ±5V / VBAT / 5VSB**

Detect system's voltage status automatically.

Supervisor / User Password

When you select this function, the following message will appear at the center of the screen to assist you in creating a password.

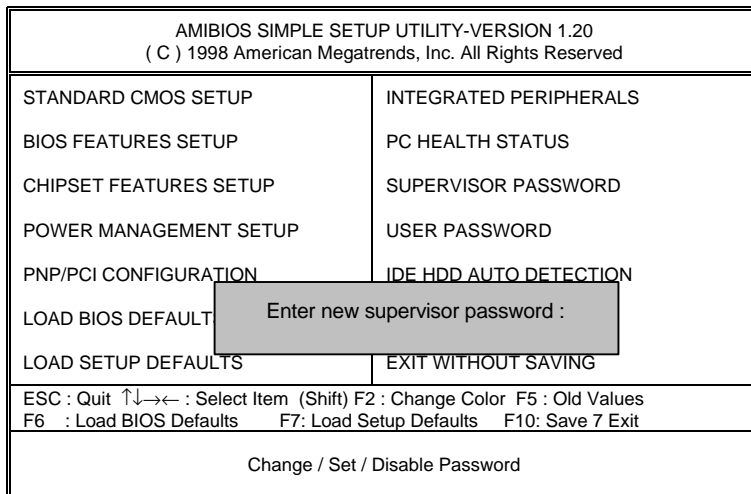

Figure 11: Password Setting

Type the password, up to eight characters, and press <Enter>. The password typed now will clear the previously entered password from CMOS memory. You will be asked to confirm the password. Type the password again and press <Enter>.

To disable password, just press <Enter> when you are prompted to enter password. A message "PASSWORD DISABLED" will appear to confirm the password being disabled. Once the password is disabled, the system will boot and you can enter Setup freely.

If you select System at Security Option in BIOS Features Setup Menu, you will be prompted for the password every time the system is rebooted or any time you try to enter Setup Menu. If you select Setup at Security Option in BIOS Features Setup Menu, you will be prompted only when you try to enter Setup.

IDE HDD Auto Detection

AMIBIOS SETUP – STANDARD CMOS SETUP (C) 1998 American Megatrends, Inc. All Rights Reserved	
Date (mm/dd/yyyy) : Fri Dec 25, 1998 Time (hh/mm/ss) : 10:36:24 TYPE SIZE CYLS HEAD PRECOMP LANDZ SECTOR MODE	
Pri Master : Auto Pri Slave : Auto Sec Master: Auto Sec Slave : Auto	
Floppy Drive A: 1.44 MB 3 ½ Floppy Driver B: Not Installed Boot Sector Virus Protection : Disabled	Base Memory : 640 kb Other Memory: 384 kb Extended Memory: 31mb Total Memory: 32mb
Month: Jan – Dec Day: 01 – 31 Year : 1901– 2099	ESC : Exit ↑↓ : Select Item PU/PD/+/- : Modify (Shift)F2 : Color

Figure 12: IDE HDD Auto Detection

Type "Y" will accept the H.D.D. parameter reported by BIOS.

Type "N" will keep the old H.D.D. parameter setup. If the hard disk cylinder number is over 1024, then the user can select LBA mode or LARGER mode for DOS partition larger than 528 MB.

Save & Exit Setup

AMIBIOS SIMPLE SETUP UTILITY-VERSION 1.20 (C) 1998 American Megatrends, Inc. All Rights Reserved	
STANDARD CMOS SETUP	INTEGRATED PERIPHERALS
BIOS FEATURES SETUP	PC HEALTH STATUS
CHIPSET FEATURES SETUP	SUPERVISOR PASSWORD
POWER MANAGEMENT SETUP	USER PASSWORD
PNP/PCI CONFIGURATION	IDE HDD AUTO DETECTION
LOAD BIOS DEFAULTS	
LOAD SETUP DEFAULTS	
ESC : Quit ↑↓→← : Select Item (Shift) F2 : Change Color F5 : Old Values F6 : Load BIOS Defaults F7: Load Setup Defaults F10: Save & Exit	
Save Data to CMOS & Exit SETUP	

Figure 13: Save & Exit Setup

Type "Y" will quit the Setup Utility and save the user setup value to RTC CMOS.

Type "N" will return to Setup Utility.

Exit Without Saving

AMIBIOS SIMPLE SETUP UTILITY-VERSION 1.20 (C) 1998 American Megatrends, Inc. All Rights Reserved	
STANDARD CMOS SETUP	INTEGRATED PERIPHERALS
BIOS FEATURES SETUP	PC HEALTH STATUS
CHIPSET FEATURES SETUP	SUPERVISOR PASSWORD
POWER MANAGEMENT SETUP	USER PASSWORD
PNP/PCI CONFIGURATION	IDE HDD AUTO DETECTION
LOAD BIOS DEFAULTS	Quit without saving (Y/N)? N
LOAD SETUP DEFAULTS	
ESC : Quit ↑↓→← : Select Item (Shift) F2 : Change Color F5 : Old Values F6 : Load BIOS Defaults F7: Load Setup Defaults F10: Save & Exit	
Abandon all Datas & Exit SETUP	

Figure 14: Exit Without Saving

Type "Y" will quit the Setup Utility and save the user setup value to RTC CMOS.

Type "N" will return to Setup Utility.

Appendix

Appendix A: AMD Series Chipset Driver Installation

A. AMD EIDE Driver

Insert the support CD that came with your motherboard into your CD-ROM drive or double-click the CD drive icon in **My Computer** to bring up the setup screen.

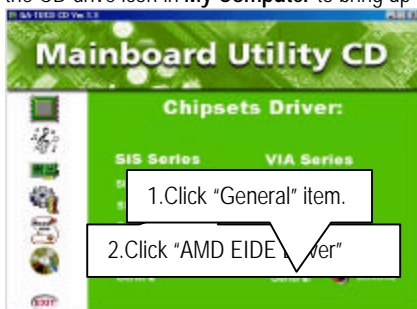

(1)



(2)

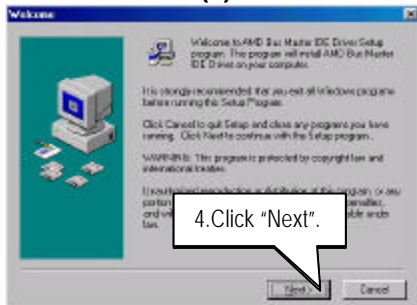

(3)

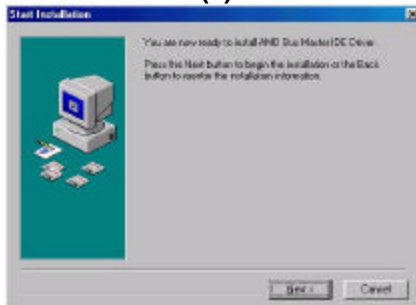

(4)

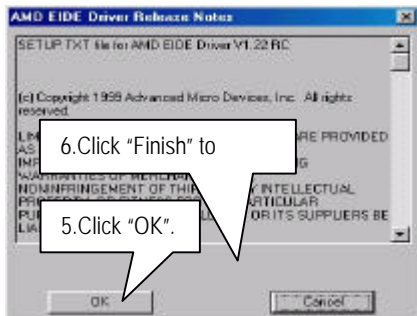

(5)

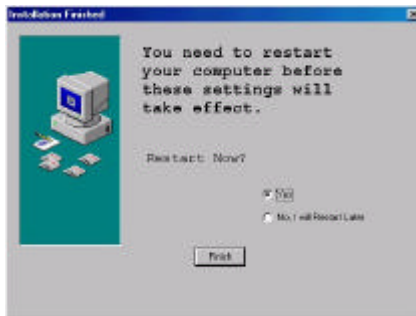

(6)

B. AMD AGP Miniport Driver

Insert the support CD that came with your motherboard into your CD-ROM drive or double-click the CD drive icon in **My Computer** to bring up the setup screen.

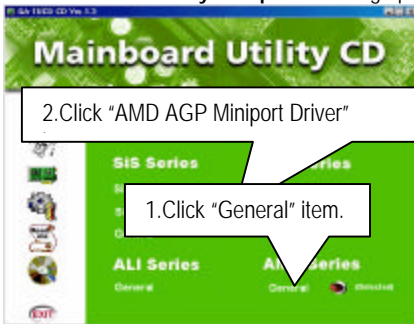

(1)

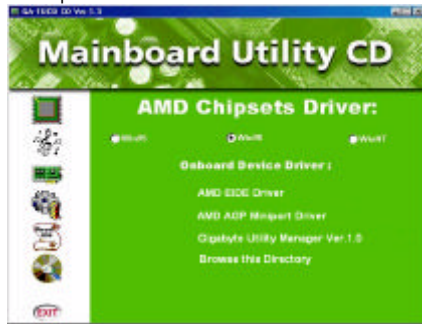

(2)

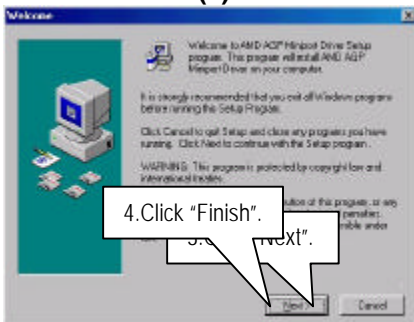

(3)

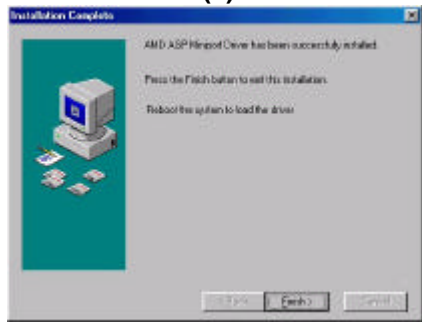

(4)

7IXE Motherboard

C. Gigabyte Utility Manager Ver.1.0

Insert the support CD that came with your motherboard into your CD-ROM drive or double-click the CD drive icon in **My Computer** to bring up the setup screen.

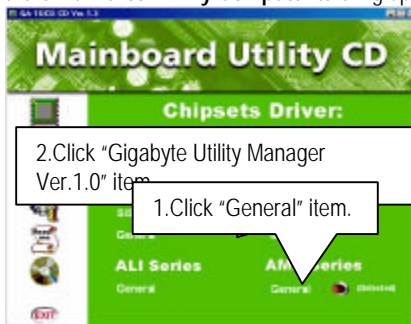

(1)



(2)

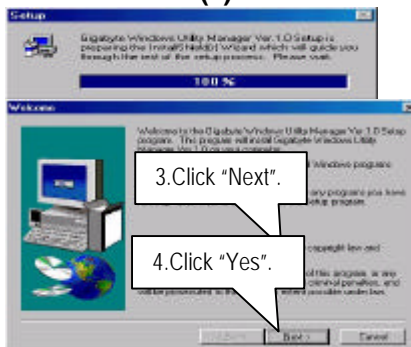

(3)

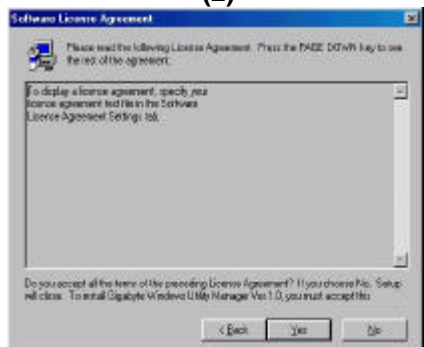

(4)

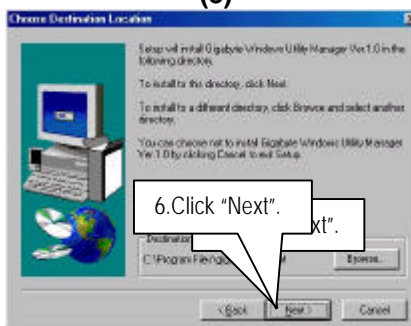

(5)

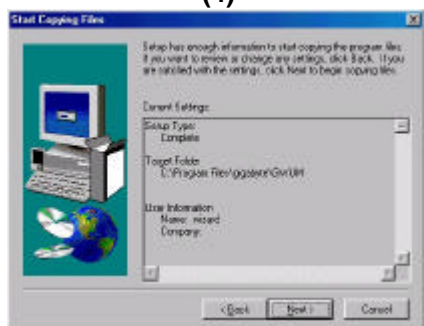

(6)



(7)

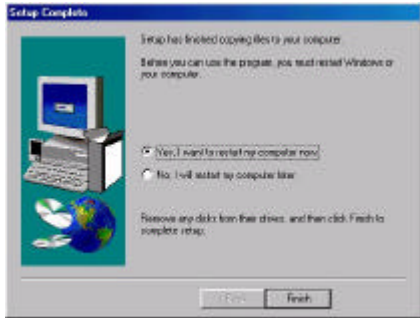

(8)

Appendix B: BIOS Flash Procedure

BIOS update procedure:

Please check your BIOS vendor (AMI or AWARD) on the motherboard.

It is recommended you copy the AWDFlash.exe or AMIFlash.exe in driver CD (D:\>Utility\BIOSFlash) and the BIOS binary files into the directory you made in your hard disk. i.e.C:\>Utility\ (C:\>Utility : denotes the driver and the directory where you put the flash utilities and BIOS file in.)

Restart your computer into MS-DOS mode or command prompt only for Win95/98, go into the directory where the new BIOS file are located use the utility AWDFlash.exe or AMIFlash.exe to update the BIOS.

Type the following command once you have enter the directory where all the files are located

```
C:\utility\ AWDFlash or AMIFlash <filename of the BIOS binary file intended for flashing>
```

Once the process is finished, reboot the system

Note: Please download the newest BIOS from our website (www.gigabyte.com.tw) or contact your local dealer for the file.

Appendix C: Acronyms

Acor.	Meaning
ACPI	Advanced Configuration and Power Interface
POST	Power-On Self Test
LAN	Local Area Network
ECP	Extended Capabilities Port
APM	Advanced Power Management
DMA	Direct Memory Access
MHz	Megahertz
ESCD	Extended System Configuration Data
CPU	Central Processing Unit
SMP	Symmetric Multi-Processing
USB	Universal Serial Bus
OS	Operating System
ECC	Error Checking and Correcting
IDE	Integrated Dual Channel Enhanced
SCI	Special Circumstance Instructions
LBA	Logical Block Addressing
EMC	Electromagnetic Compatibility
BIOS	Basic Input / Output System
SMI	System Management Interrupt
IRQ	Interrupt Request
NIC	Network Interface Card
A.G.P.	Accelerated Graphics Port
S.E.C.C.	Single Edge Contact Cartridge
LED	Light Emitting Diode
EPP	Enhanced Parallel Port
CMOS	Complementary Metal Oxide Semiconductor
I/O	Input / Output
ESD	Electrostatic DISCHARGE
OEM	Original Equipment Manufacturer
SRAM	Static Random Access Memory
VID	Voltage ID
DMI	Desktop Management Interface
MIDI	Musical Interface Digital Interface
IOAPIC	Input Output Advanced Programmable Input Controller
DIMM	Dual Inline Memory Module
DRAM	Dynamic Random Access Memory
PAC	PCI A.G.P. Controller
AMR	Audio Modem Riser

To be continued...

7IXE Motherboard

Acor.	Meaning
PCI	Peripheral Component Interconnect
RIMM	Rambus in-line Memory Module
DRM	Dual Retention Mechanism
ISA	Industry Standard Architecture
MTH	Memory Translation Hub
CRIMM	Continuity RIMM