

# Installation Guide

# **IDE *Plus*** ***by Boca***

PRODUCT CODE: IDEG21



## Before You Begin your Installation

The product you have purchased is designed to be easily installed into most IBM PC or compatible systems. Many products have large, easy-to-read legends to allow for the easy configuring of the product. This installation manual contains detailed instructions. Most included software has automatic installation programs to place the software correctly onto your computer. However, as all computers are configured differently, you may be required to perform some basic DOS or Windows tasks. If you are not familiar with basic DOS commands such as DIR, CD, or EDIT, you should check your DOS manual, or seek assistance from you local computer dealer to install the product.

### *How to get Technical Assistance*

The dealer that you purchased this product or your computer from is the first place you should go for technical assistance. The dealer is usually the most qualified source of help, and is most familiar with your system and how this product should be installed. Many dealers have customer service and technical support programs, with varying levels of support offered, depending on your needs and computer knowledge. ***Please contact the dealer first whenever a problem occurs.***

### *If your Dealer Can't Assist you*

If you can't get assistance from your dealer, the manufacturer provides varying levels of technical assistance as summarized on the following page.

The Standard Free Technical Support number is for quick answers to specific inquiries on product features and technical questions (call **407-241-8088**; M-F, 8 am to 6:30 pm EST). Direct access to technical support representatives is provided on a limited basis.

---



**Boca BBS**  
407-241-1601



**Automated Fax  
Retrieval System**  
407-995-9456



**Technical Support Fax**  
407-997-0918



**Standard Free  
Technical Support**  
407-241-8088



**Priority Service**  
900-555-4900  
(\$2 per minute)

**On-Line Support!**  
**CompuServe: GO BOCA**  
**Internet:**

**email: support@boca.org**  
**World-wide on the WEB:**  
**http://WWW@boca.org**



If you require immediate attention or in-depth help with the installation of the product, please call our 900-priority support number for service. This number gives you immediate access to senior-level technicians. The number is **900-555-4900**. You will be charged \$2.00 per minute. The charges will appear on your next phone bill.

## ***Damaged or Missing Items***

We use many world-class quality assurance programs to ensure the product you purchased is of the highest caliber. Sometimes, however, a component may be missing from the box, or is damaged or corrupt in some way. If this happens, immediately return the entire package to your place of purchase so you may exchange it for a new one. Your dealer should be able to provide you with an exchange far more quickly than by contacting us directly. If for some reason you are unable to return the product directly to its place of purchase, refer to the “Servicing Your Product” and “Warranty” sections in this manual for instructions.

---

---

# Contents

<b>Introduction</b> .....	<b>6</b>
<b>Section One: Getting Started</b> .....	<b>8</b>
<b>Section Two: QuickStart</b> .....	<b>10</b>
<b>Section Three: Features</b> .....	<b>11</b>
3.1 Parallel Printer Interface .....	11
3.2 Serial Device Interface .....	12
3.3 Drive Interface .....	16
<b>Section Four: Setting Jumpers</b> .....	<b>17</b>
4.1 Changing the Default Jumper Configurations .....	19
4.2 Enabling/Disabling Drives .....	20
4.3 Primary/Secondary Drive Addresses .....	21
4.4 Configuring Hard Drive IRQs .....	23
4.5 Sample Jumper Configuration .....	24
<b>Section Five: Physical Installation</b> .....	<b>26</b>
5.1 Removing the System Cover .....	26
5.2 Inserting the IDE Plus controller .....	26
5.3 Attaching Internal Cables .....	27
5.4 Replacing the System Cover .....	28
5.5 Attaching External Cables .....	29
<b>Appendix A: Troubleshooting</b> .....	<b>30</b>
<b>Appendix B: Servicing Your Boca Product</b> .....	<b>32</b>
<b>Appendix C: Pin Assignments</b> .....	<b>35</b>
<b>FCC Compliance</b> .....	<b>37</b>
<b>Warranty</b> .....	<b>38</b>

---

## Introduction

Congratulations on purchasing the IDE Plus Controller from Boca Research for ISA- and EISA-based systems. The important advantage of IDE technology is having the fixed disk controller logic incorporated onto the drive itself. This enables a faster access time when retrieving and recording data. The IDE interface also provides more reliable performance than older MFM and RLL encoding standards. The IDE Plus offers:

- a 25-pin IBM PC/AT compatible parallel printer port
- a 9-pin PC/AT compatible serial port (SERIAL port A).
- a 25-pin serial port (SERIAL port B).
- hard drive and diskette drive enable/disable capability
- hard drive primary/secondary selection
- primary and secondary IRQ for hard drive
- LED connector

You can select the address and IRQs used for each port via an array of jumpers located on the IDE Plus. Other features include:

- Diskette drive interface
- Hard drive interface
- 16-bit interface
- I/O addresses:
  - Serial A (COM1 or COM3; IRQ4 or IRQ7), or Disabled.
  - Serial B (COM2 or COM4; IRQ3 or IRQ5), or Disabled.
- LPT 1-2 or disabled (IRQ 5 or 7)

Using a high-speed dual NS16450 compatible UART chip for the serial ports, the IDE Plus controller is specifically designed to work with ISA and EISA systems.

See Section Three for additional details on features and capabilities.

If you are an **experienced** computer user who wishes to take some shortcuts through installation, refer to Section Two: Quickstart. Otherwise, please read the entire manual before attempting to install the IDE Plus controller.

---

## Section One: Getting Started

Before going any further, please be sure that the following items have been included in your IDE Plus package:

- The IDE Plus controller
- A 25-pin serial connector and bracket assembly with cable
- A 40-pin IDE hard drive cable
- A 34-pin diskette drive cable

Please examine the IDE Plus controller for any visible damage which may have occurred during shipment. If damage exists or if any items are missing, please contact the retailer from whom the IDE Plus was purchased.

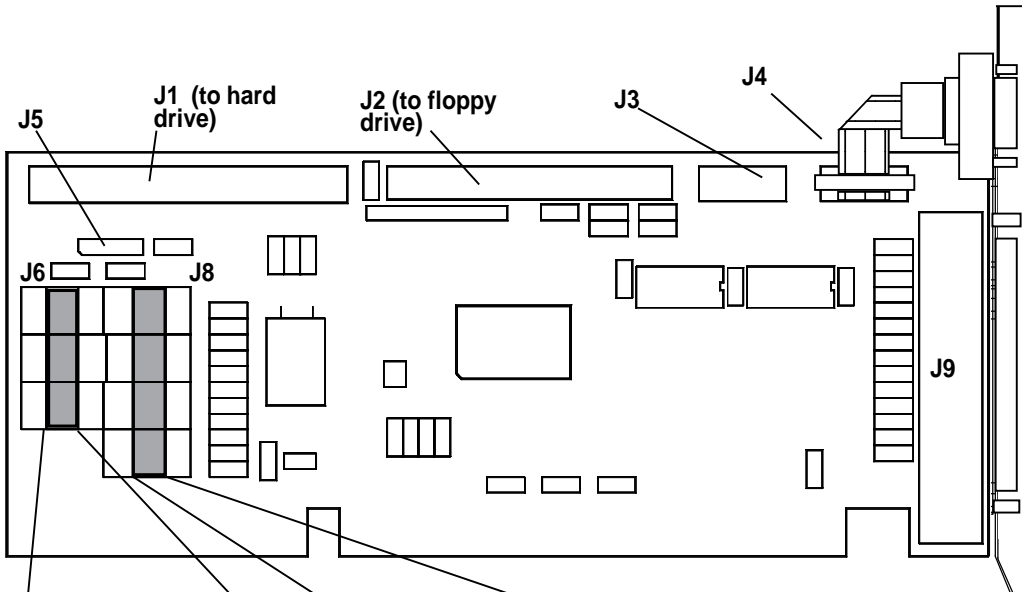

**J6**

	● ●	PRI
	■ ■	HDD
	● ●	SEC
IRQ7	■ ■	IRQ14
PAR	■ ■	HDD
IRQ5	● ●	IRQ15
IRQ 4	■ ■	IRQ 3
SERA	■ ■	SER B
IRQ7	● ●	IRQ5

**J8**

ENA	■ ■	ENA
SER A	■ ■	SER B
DIS	● ●	DIS
COM1	■ ■	COM2
SERA	■ ■	SERB
COM3	● ●	COM4
ENA	■ ■	ENA
PAR	■ ■	HDD
DIS	● ●	DIS
378	■ ■	ENA
PAR	■ ■	FDD
278	● ●	DIS

**Jumper  
Locations and  
Default Settings  
for the IDE Plus**

## Section Two: QuickStart

- Configure the jumpers or accept the default settings (see diagram on previous page).
- Insert the IDE Plus controller in any available 16-bit expansion slot.
- Connect one end of the 34-pin floppy cable to your floppy drive and the other end to the **J2** connector on the IDE Plus. Make sure the colored stripe (often red) goes to Pin 1.
- Connect one end of the 40-pin hard drive cable to your hard disk drive and the other end to the **J1** connector on the IDE Plus. Make sure the colored stripe (often red) goes to Pin 1.
- Attach your serial device to **J4** (serial port A) and your parallel printer to **J9**. Secure the serial connector and bracket assembly to a vacant rear slot. Attach the free end of the cable to **J3** (serial port B) on the IDE Plus. Then attach your serial device to the external connector on the bracket assembly.
- Power up your system using a DOS diskette.
- If you connected the IDE Plus to a **new** hard drive, run FDISK and FORMAT to prepare your IDE hard drive for use; otherwise, simply power up your system and the IDE Plus will automatically recognize your **existing** drive.

## Section Three: Features

### 3.1 Parallel Printer Interface (J9)

The parallel printer interface has a 25-pin female D-shell connector, and is designed to connect to IBM and IBM compatible printers via an IBM printer cable. This port is IBM PC/AT compatible. The parallel port can be set via a jumper for one of the following options:

**J8**

ENA SER A DIS		ENA SER B DIS
COM1 SERA COM3		COM2 SERB COM4
ENA PAR DIS		ENA HDD DIS
378 PAR 278		ENA FDD DIS

**LPT1 @0378h**

**J8**

ENA SER A DIS		ENA SER B DIS
COM1 SERA COM3		COM2 SERB COM4
ENA PAR DIS		ENA HDD DIS
378 PAR 278		ENA FDD DIS

**LPT2@0278h**

**J8**

ENA SER A DIS		ENA SER B DIS
COM1 SERA COM3		COM2 SERB COM4
ENA PAR DIS		ENA HDD DIS
378 PAR 278		ENA FDD DIS

**LPT DISABLED**

IBM has defined 0378 and 0278 as the hexadecimal I/O port addresses for LPT1 and LPT2, respectively. The interrupt for the parallel port is IRQ7 or IRQ5. These interrupts are set using the appropriate jumper on **J6** (PAR IRQ7/PAR IRQ5).

## 3.2 Serial Device Interface (J3, J4)

**General Notes:** IBM has defined that IRQ4 is assigned to COM1 and IRQ3 is assigned to COM2; these are needed for interrupt driven devices such as Mice. In general, serial ports cannot share a common interrupt, nor can they share the same physical port. COM3 and COM4 are not supported by IBM's (and most clones') system BIOS. IBM never intended COM3 or COM4 to be initialized during boot-up. Your application software will need to initialize these COM ports.

### Serial Device Interface A (J4)

The IDE Plus controller is designed using a high speed, AT-type dual UART NS16450 compatible chip for the serial ports. Serial device interface "A" has a 9-pin male D-shell connector, and is used to connect to any asynchronous serial device using a standard EIA RS-232 interface. Examples of such devices are serial printers, plotters, and modems. Serial port "A" can be set via the **J8** jumper for one of the following three options:

**J6****COM1/IRQ4**

	● □ ● ●	PRI HDD SEC
IRQ7 PAR IRQ5	□ □ ● ●	IRQ14 HDD IRQ15
IRQ 4 SERA IRQ7	□ □ ● ●	IRQ 3 SER B IRQ5

**J8**

ENA SER A DIS	□ □ ● ●	ENA SER B DIS
COM1 SERA COM3	□ □ ● ●	COM2 SERB COM4
ENA PAR DIS	● □ □ □ ● ●	ENA HDD DIS
378 PAR 278	● □ ● ● ● ●	ENA FDD DIS

**J6****COM3/IRQ4**

	● □ ● ●	PRI HDD SEC
IRQ7 PAR IRQ5	□ □ ● ●	IRQ14 HDD IRQ15
IRQ 4 SERA IRQ7	□ □ ● ●	IRQ 3 SER B IRQ5

**J8**

ENA SER A DIS	□ □ ● ●	ENA SER B DIS
COM1 SERA COM3	● □ □ □ ● ●	COM2 SERB COM4
ENA PAR DIS	● □ □ □ ● ●	ENA HDD DIS
378 PAR 278	● □ ● ● ● ●	ENA FDD DIS

## J8

**SERIAL PORT A  
DISABLED**

ENA SER A DIS	● □ □	ENA SER B DIS
COM1 SERA COM3	□ □ ● ●	COM2 SERB COM4
ENA PAR DIS	□ □ ● ●	ENA HDD DIS
378 PAR 278	□ □ ● ●	ENA FDD DIS

### Serial Device Interface B (J3)

This serial device interface has a 25-pin male D-shell connector bracket assembly which attaches via ribbon cable to the pin connector marked **J3**. This connector is located in the upper right hand corner of the board and it can be used with the same types of devices as serial device interface “A” described earlier in this subsection. Serial port “B” can be set via the **J8** jumper for one of the three options as shown on the next page. *Note: The interrupt request choices are IRQ3 or 5. If you do not need serial port “B,” keep the logical port DISABLED.*

**J6****COM2/IRQ3**

	● □ ● ● ● ●	PRI HDD SEC
IRQ7 PAR IRQ5	□ □ ● ●	IRQ14 HDD IRQ15
IRQ 4 SERA IRQ7	□ □ ● ●	IRQ 3 SER B IRQ5

**J8**

ENA SER A DIS	□ □ ● ●	ENA SER B DIS
COM1 SERA COM3	□ □ ● ●	COM2 SERB COM4
ENA PAR DIS	● □ □ ●	ENA HDD DIS
378 PAR 278	● □ ● ●	ENA FDD DIS





**J6****COM4/IRQ3**

	● □ ● ● ● ●	PRI HDD SEC
IRQ7 PAR IRQ5	□ □ ● ●	IRQ14 HDD IRQ15
IRQ 4 SERA IRQ7	□ □ ● ●	IRQ 3 SER B IRQ5

**J8**

ENA SER A DIS	□ □ ● ●	ENA SER B DIS
COM1 SERA COM3	□ □ ● ●	COM2 SERB COM4
ENA PAR DIS	● □ □ ●	ENA HDD DIS
378 PAR 278	● □ ● ●	ENA FDD DIS

**J8****SERIAL PORT B  
DISABLED**

ENA SER A DIS		ENA SER B DIS
COM1 SERA COM3		COM2 SERB COM4
ENA PAR DIS		ENA HDD DIS
378 PAR 278		ENA FDD DIS

**3.3 Drive Interfaces**

The **J1** connector on the IDE Plus interface provides a 40-pin connector for an IDE drive cable which can support one or two IDE hard drives. The **J2** connector provides a 34-pin connector for a floppy drive cable which can support one or two floppy drives. In both cases, cabling is keyed with a colored stripe (often red) for pin 1.



---

---





## Section Four: Setting Jumpers

Before you install the IDE Plus controller, you need to set the jumpers for your configuration. Always turn the system off before attempting the reconfiguration, removal, or installation of the IDE Plus controller. You can change configurations on the IDE Plus controller simply by moving a jumper or combination of jumpers from one pair of pins to another. Place the board in front of you, component side up, with the bracket on your right. The settings are shown default settings for an IDE Plus controller being installed in an IBM AT or compatible. In this sample installation, the IDE Plus is the first I/O support board being added to the system and is configured as:





Parallel		Serial A		Serial B	
IO Port Address	IRQ	Port	IRQ	Port	IRQ
0378 (LPT1)	IRQ7	COM1	IRQ4	COM2	IRQ3

---





**J8**

ENA SER A DIS		ENA SER B DIS
COM1 SERA COM3		COM2 SERB COM4
ENA PAR DIS		ENA HDD DIS
378 PAR 278		ENA FDD DIS

**LPT1 @0378h****J8**

ENA SER A DIS		ENA SER B DIS
COM1 SERA COM3		COM2 SERB COM4
ENA PAR DIS		ENA HDD DIS
378 PAR 278		ENA FDD DIS

**LPT2@0278h****J8**

ENA SER A DIS		ENA SER B DIS
COM1 SERA COM3		COM2 SERB COM4
ENA PAR DIS		ENA HDD DIS
378 PAR 278		ENA FDD DIS

**LPT DISABLED****Default Position of Jumpers****Note on Printer Selection**

Printer ports can be described in either of two ways: logical and physical. Logical printer ports are what we would understand as a first or second printer port, i.e., LPT1 or LPT2. A physical port is defined as the actual hexadecimal address of the printer port, i.e., 03BCh, 0378h, or 0278h. The system BIOS first searches for a printer port at 03BCh. If one is not found, 0378h is checked. If a port is found at 0378h, it is initialized as LPT1. If two ports are found, 03BCh is initialized as LPT1, and 0378h is then initialized as LPT2. Most monochrome video boards with a parallel printer port attached use I/O address 03BCh. If the IDE Plus controller is configured for LPT1 (0378h) and a mono-video board is present in the system, the IDE Plus's parallel port will be seen as LPT2.

## 4.1 Changing the Default Jumper Configurations

Locate the jumper blocks labelled **J6** and **J8** (on the left side of the board with the bracket on your right) which consists of a 2x12 and 2x9 matrix, respectively.

### Configuring the LPT Ports

The two pins beside **PAR ENA** must be jumpered. Connecting the two pins beside **PAR 378** configures the parallel port for an LPT1 at 0378h/IRQ 5 or IRQ7. If you have an existing LPT1, position the jumper over the pins beside **PAR 278** for an LPT2 at I/O base address 0278h/IRQ5 or IRQ7. If the parallel port is to be **DISABLED**, the two pins beside **PAR DIS** must be jumpered. Set the IRQ for this port by jumpering the appropriate two pins on **J6 (PAR IRQ7/PAR IRQ9)**.

### Configuring the COM Ports

The two pins beside **SERA ENA** and/or **SERA B ENA** must be jumpered. The COM port jumpers for Serial A are labelled COM1 and COM3. For Serial B, they are labelled COM2 and COM4. To set the COM ports, simply move the jumper to the pins beside the appropriate COM designation. COM port and IRQ assignments are as shown below. If serial port A and/or B is to be **DISABLED**, the two pins beside **SER A DIS** or **SER B DIS** must be jumpered.

---

COM Port

1  
2  
3  
4

IRQ

4 or 7  
3 or 5  
4 or 7  
3 or 5

These IRQs are set using the Serial A and Serial B jumpers on J8. Jumper the appropriate pins.

## 4.2 Enabling/Disabling Drives

Set jumpers as shown to enable or disable the hard disk drive and/or floppy disk drive. This may be necessary with computers which feature hard disk drive and floppy disk drive connectors directly on the system board.

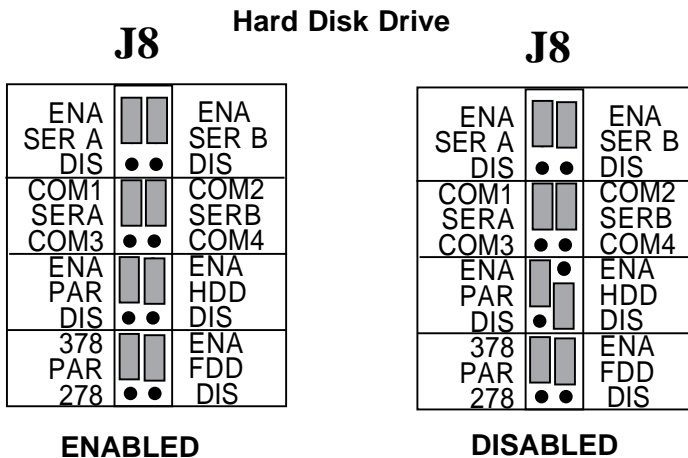

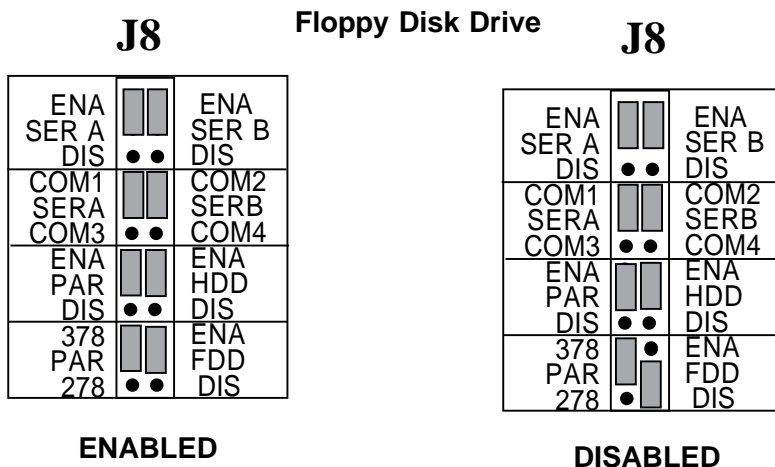

### 4.3 Configuring Primary/Secondary Drive Addresses

The primary and secondary addressing jumpers are located on the upper portion of jumper block **J6** and are used for the hard drive interface (HDD). Primary addresses are set as shown on the next page:

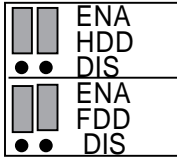
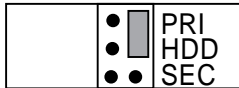
**J8****J6**

These jumpers would be configured as above if the IDE Plus were the first or only hard and floppy drive controller in the system. Below are other common configurations:

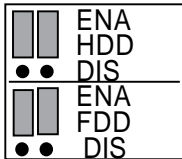
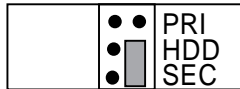
**J8****J6**

Board is used for secondary hard and primary floppy support in the system.

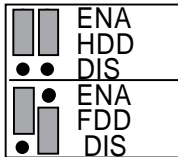
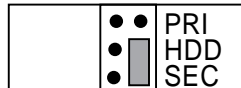
**J8****J6**

Secondary hard drive, but NO additional floppy support is needed. FDD is disabled. FDD DIS on J8 must be jumpered.

## 4.4 Configuring IRQs for the Hard Drive

The default setting is IRQ14 on jumper block **J6**. Having the flexibility to change to IRQ15 is beneficial in networking environments such as Novell. For example: disk duplexing, i.e., two drives running off of two controllers (controller A=IDE PRIMARY/IRQ14; B=IDE SECONDARY/IRQ15). Also note that whenever the hard drive attached to the IDE Plus is designated as the secondary drive, then the corresponding interrupt must be set to IRQ15.

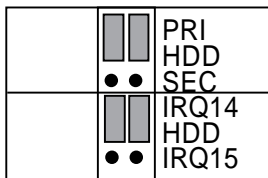
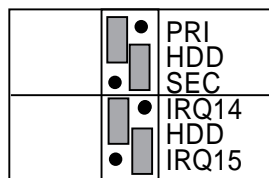
**J6****J6**

## 4.5 Sample Jumper Configuration

### J6

	● <input type="checkbox"/>	PRI HDD SEC
IRQ7 PAR IRQ5	<input type="checkbox"/> <input type="checkbox"/>	IRQ14 HDD IRQ15
IRQ 4 SERA IRQ7	<input type="checkbox"/> <input type="checkbox"/>	IRQ 3 SER B IRQ5

### J8

ENA SER A DIS	<input type="checkbox"/> <input type="checkbox"/>	ENA SER B DIS
COM1 SERA COM3	● <input type="checkbox"/>	COM2 SERB COM4
ENA PAR DIS	<input type="checkbox"/> <input type="checkbox"/>	ENA HDD DIS
378 PAR 278	● <input type="checkbox"/>	ENA FDD DIS

This is an example of the jumper settings when installing the IDE Plus controller in a system already containing a serial and parallel port. Configuration would be as follows: This example assumes you have your system serial port configured as COM1 (03F8h/IRQ4) and the parallel port as LPT1 (0378h/IRQ7). When the parallel ports are installed, the system parallel port is initialized first and is seen as LPT1. The IDE parallel port will then be initialized as LPT2. See **Note on Printer Selection** on page 16 for further information on how parallel ports are initialized.



---

---

<b>Parallel</b>		<b>Serial A</b>		<b>Serial B</b>	
IO Port Address	IRQ	Port	Int	Port	Int
0278	IRQ7	COM3	IRQ4	COM2	IRQ3

---

## Section Five: Physical Installation

### 5.1 Removing the System Cover

1. Power down the system and remove the power cord from the back of the system.
2. Unplug the keyboard cable as well as all cables to monitors, printers and other devices from other boards and remember where they were attached. You will need to reattach them after the installation of the IDE Plus is complete.
3. Using a small screwdriver, remove the screws that attach the system's cover to the rear panel. Carefully remove the cover, being careful not to let the cover catch on internal cables to the disk drive and power supply. Once the cover is off, you will be able to see the internal components and adapter boards inside.

### 5.2 Inserting the IDE Plus controller

1. Select an empty expansion slot and remove the screw and the metal plate that covers the external access to the slot you have selected.
2. Insert the IDE Plus controller in the slot you have selected so the edge connector on the bottom rear of the board mates with the connector on the motherboard (system board). Press down firmly on the board.

3. Use the removed screw to secure the board. *NOTE: Depending on the physical layout of your system, it may be easier to attach drive and LED cables before inserting the IDE into the slot on the system board.*

## 5.3 Attaching Internal Cables

1. Attach the appropriate cables and secure for the following connectors:

**Drive Activity LED J5      Serial B Connector J3 (if used)**

2. Attach one end of the 40-pin cable to the hard disk drive in the system and the other end to the **J1** connector on the IDE controller. Make sure Pin 1 on the cable is mated to Pin 1 on the IDE Plus and on your hard drive. Don't forget to connect the hard drive to the system's power supply. If connecting and configuring a second hard drive, refer to your drive manufacturer's documentation.
3. Attach one end of the 34-pin cable to the floppy drive in the system and the other end to the **J2** connector on the IDE controller.

*NOTE: When connecting cables, be sure that Pin 1 on the cable, usually marked with a colored stripe (often red), matches up with pin 1 on the board connector.*

---

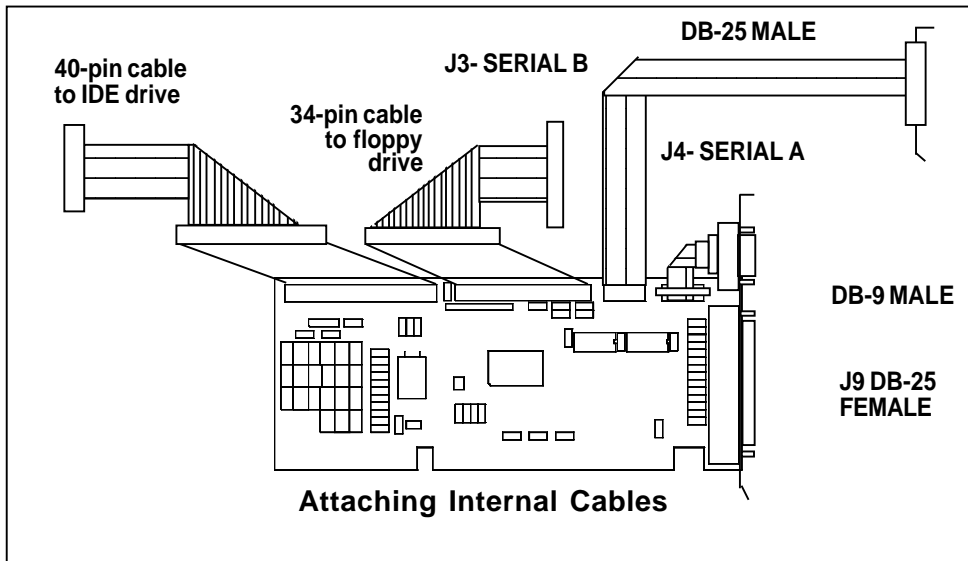

## 5.4 Replacing the System Cover

Slide the cover back over the chassis taking care not to let it snag on the disk drive or power cables. Once the cover is in place, replace all screws that you removed earlier. Reconnect all previously removed cables.

## 5.5 Attaching External Cables

Attach the appropriate cables for the external parallel printer connector (J9) and Serial Connector A (J4) as necessary and secure with the screws provided at the end of the cable connector. Physical installation is complete. **If you connected the IDE Plus to a *NEW* hard drive**, power up the system and run FDISK and FORMAT to prepare your hard disk drive for use. **If you connected the IDE Plus to an *EXISTING* hard drive**, simply power up the system and the controller will automatically recognize the drive.

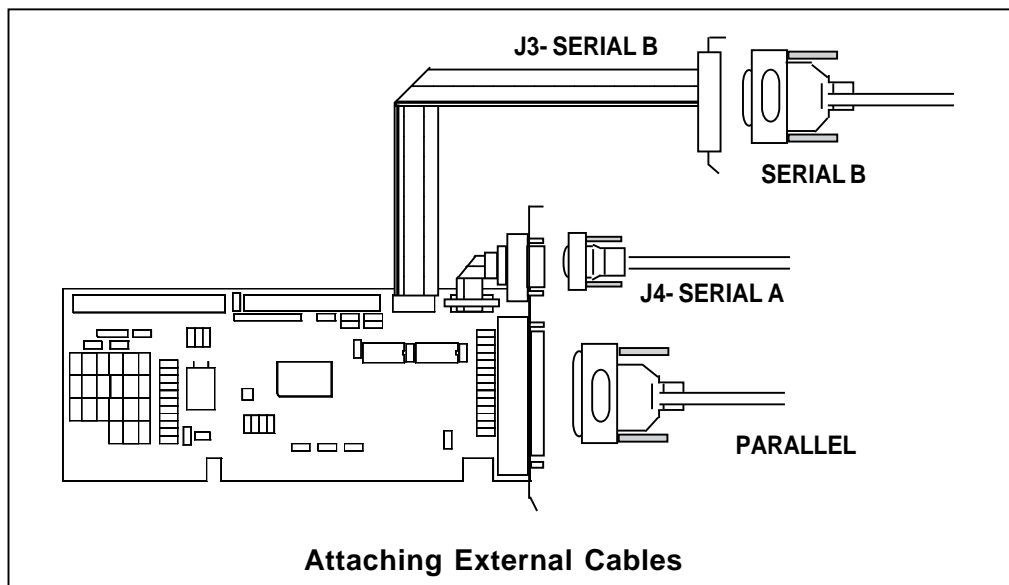

## Appendix A: Troubleshooting

Before contacting your dealer, review the following list of problems and solutions to see if any of them apply to your situation.

**PROBLEM:** Hard drive or diskette drive will not respond.

**SOLUTION:** Verify that cable connection is pin 1 to pin 1. Make sure drive is attached to power supply. Check all cable connections.

**PROBLEM:** Do I need to low-level format my IDE hard drive?

**SOLUTION:** NO. Low-level formatting is used to set up communications between the hard drive and the controller chips on the interface card. With Integrated Disk Electronics technology, the IDE hard drive has the controller logic integrated onto the hard drive itself. You need only run FDISK and FORMAT.

**PROBLEM:** No response from a peripheral device (i.e. printer, plotter, modem, etc.).

**SOLUTION:** Verify that the peripheral device is powered on, ready, on-line, and/or securely connected at BOTH ends of the cable. Be sure the application software is configured to recognize the port that you are attempting to use and that the port in question is actually the port intended to be active. Check the IDE Plus jumper settings to insure that the intended port is enabled and that there are no conflicting ports or shared interrupts.

**PROBLEM:** LPT2 will not perform a print screen (shift-PrtSc).

**SOLUTION:** The system is functioning normally. The print screen function defaults to LPT1. If you wish to test the port after installation copy an ASCII text file (NOTE: the example may not exist on your boot disk) to an active device, i.e., COPY AUTOEXEC.BAT LPT2 at the DOS prompt.

**PROBLEM:** COM3 and/or COM4 do not function (not initialized).

**SOLUTION:** The system is functioning normally. IBM never intended COM3 or COM4 to be initialized during boot-up. (The BIOS in some later systems may allow initializing of these ports; check the system manual). Your application software will have to initialize these COM ports. Consult the manual/publisher of your application software to see if the software can address a specific I/O port address such as 03E8h for COM3 or 02E8h for COM4. An IRQ may or may not be required; you will have to verify this.

**PROBLEM:** I am not sure how to set the COM ports.

**SOLUTION:** In general, IRQ4 belongs to COM1; IRQ3 belongs to COM2. It is best to put an interrupt driven device on COM1 or 2 (i.e., a mouse) and put a non-interrupt driven device on COM3 or 4 (i.e., a printer).

---

## Appendix B: Servicing Your Boca Product

If your IDE Plus requires service, first contact the authorized dealer from whom you purchased the IDE Plus. If the dealer is unable to assist you, and you must contact Boca Research, Inc., please follow the instructions below.

Our electronic BBS is available 24 hours a day at (407) 241-1601 and will support data transmission speeds up to 28.8Kbps with settings of N, 8, 1. If you have a modem, the BBS may be helpful (especially during off hours) if you have a question about product settings or compatibility, or if you wish to download driver software or utilities.

If the Troubleshooting section (Appendix A) did not resolve your problem, you may call our technical support staff for assistance. If you have not referred to the Troubleshooting section, there's a good chance the solution to your problem is there.

**NOTE: CALLING TECHNICAL SUPPORT WITHOUT COMPLETE AND ACCURATE INFORMATION CONCERNING YOUR PROBLEM MAY BE BOTH TIME-CONSUMING AND FRUSTRATING FOR YOU.**

1. When calling Boca Research Technical Support, have the following information available:
  - Board name and part number (located on the board)
  - Computer manufacturer
  - Computer model
  - Peripherals in system
  - Operating system and version



If you suspect a problem with a specific program or software package, make note of the name, version or release number, and manufacturer of the software.

2. Call Boca Research Technical Support Department between the hours of 8:00 a.m. and 6:30 p.m. EST Monday through Friday at (407) 241-8088. A technical support specialist will be available to discuss the problem(s) you are experiencing.

If factory service is required, you will be given a Return Merchandise Authorization (RMA) number. **Please place this number on the outside of the package** when you return the item(s) for service and reference it on any correspondence included in the package. Boca Research, Inc. will return any product which is not accompanied by an RMA number.

3. Refer to the Warranty Statement if the product is covered under the five-year Boca Research, Inc. Limited Warranty.
  4. Certain parts will not be covered under the Boca Research, Inc. Limited Warranty. Dealer installed parts are warranted by the dealer. Parts which you have installed yourself are covered only by the suppliers warranties. In these cases, Boca Research, Inc. can identify which parts are defective, but will not replace such parts until specific written authorization is received from you. The cost of parts and labor involved in making such repairs will be billed to you C.O.D.
-

5. When sending the IDE Plus to Boca Research, Inc. for repairs, please be sure to include:

- the Boca Research IDE Plus (**BOARD ONLY**)
- copy of the original invoice
- your return street address (for UPS purposes)
- your phone number
- the RMA number mentioned above.

Package the product securely in a container equivalent to the original packaging, and insure the package to protect against loss or damage during transit. Shipping charges must be prepaid; C.O.D. shipments will not be accepted. Please use the address below for all correspondence:

**Boca Research, Inc.**  
**RMA Department - RMA # \_\_\_\_\_**  
**1601 Clint Moore Road**  
**Boca Raton, FL 33487-2841**

6. If the repairs performed on your IDE Plus were covered by the warranty, Boca Research, Inc. will return it prepaid via UPS.

## Appendix C: Pin Assignments

This section provides the pin assignments for each port on the IDE Plus board.

### Parallel Port (J9)

Line Name	Pin #
-STROBE	1
DATA BIT 0	2
DATA BIT 1	3
DATA BIT 2	4
DATA BIT 3	5
DATA BIT 4	6
DATA BIT 5	7
DATA BIT 6	8
DATA BIT 7	9
-ACKnowledge	10
BUSY	11
Print End (out of paper)	12
SeLeCT	13
-AUTO FeED	14
-ERROR	15
-INITialize printer	16
-SeLeCT INput	17
GROUND	18-25

### Serial Port A (9-pin) (J4)

Line Name	Pin #
CARRIER DETECT	1
RECEIVE DATA	2
TRANSMIT DATA	3
DATA TERMINAL READY	4
SIGNAL GROUND	5
DATA SET READY	6
REQUEST TO SEND	7
CLEAR TO SEND	8
RING INDICATOR	9

## Serial Port B 25-pin (J3)

<b>Line Name</b>	<b>Pin #</b>
No Connection	1
TRANSMITTED DATA	2
RECEIVED DATA	3
REQUEST TO SEND	4
CLEAR TO SEND	5
DATA SET READY	6
SIGNAL GROUND	7
RECEIVED LINE SIGNAL DETECTOR	8
No Connection	9
No Connection	10
No Connection	11
No Connection	12
No Connection	13
No Connection	14
No Connection	15
No Connection	16
No Connection	17
No Connection	18
No Connection	19
DATA TERMINAL READY	20
No Connection	21
RING INDICATOR	22
No Connection	23
No Connection	24
No Connection	25

---

## FCC Compliance

This device complies with Part 15 of the FCC Rules. Operation is subject to the following two conditions: (1) This device may not cause harmful interference, and (2) this device must accept any interference received, including interference that may cause undesired operation.

This equipment generates and uses radio frequency energy and if not installed and used properly, that is, in strict accordance with the manufacturer's instructions, may cause interference to radio and television reception. The manufacturer is not responsible for any radio or television interference caused by unauthorized modifications to this equipment. Such modifications could void the user's authority to operate the equipment. The peripherals used with the IDE Plus board must comply with the limits for a **class B** computing device in accordance with the specifications in Subpart J, Part 15, of FCC rules. These rules are designed to provide reasonable protection against such interference in a residential installation. There is, however, no guarantee that interference will not occur in a particular installation.

This unit was tested with shielded cables on the peripheral devices. Shielded cables must be used with the unit to ensure compliance. If the equipment does cause interference to radio or television reception, which can be determined by turning the equipment off and on, the user is encouraged to try to correct the interference by one or more of the following measures:

- Reorient the receiving antenna
- Relocate the computer with respect to the receiver
- Move the computer away from the receiver
- Plug the computer into a different outlet so that the computer and receiver are on different branch circuits
- Use coaxial cable to connect your television or radio to your antenna

If necessary, the user should consult the dealer or an experienced radio/television technician for additional suggestions. The user may find the following booklet prepared by the Federal Communications Commission helpful: "How to Identify and Resolve Radio-TV Interference Problems"

This booklet is available from the US Government Printing Office, Washington, DC 20402, Stock No. 004000003454.

---

## **Limited Warranty**

Boca Research, Inc. (BRI) warrants to the original buyer of this BRI product that the hardware is free of defects in materials and workmanship for a period of five (5) years from the date of purchase from BRI or an authorized dealer (“the Warranty Period”). Should the product fail to be in working order at any time during the five-year period, BRI, will at its option, repair or replace this product as described below, provided that in BRI’s sole determination the part or product has not been abused, misused, repaired, or modified.

All products will be serviced and returned via ground at no charge to customers DURING the first year of service.

All returns for limited warranty service require a Return Merchandise Authorization (RMA). All customers are required to demonstrate proof of purchase when requesting an RMA. The period of warranty commences on the date of purchase. A dated copy of the sales slip must be included with the returned merchandise.

Products which require Limited Warranty service during the warranty period should be delivered to BRI at the address in the Appendix (Servicing Your Boca Product) with proof of purchase, copy of canceled check (if any), and the Return Merchandise Authorization (RMA) number provided by BRI Technical Support. Refer to the Appendix in this manual. Replacement parts or complete products will be furnished on an exchange basis only. Replaced parts and/or products become the property of BRI.

If the returned product is sent by mail, the purchaser agrees to prepay shipping charges, insure the product or assume the risk of loss or damage which may occur in transit, and to use a shipping container equivalent to the original packaging. BRI does not make any warranties in respect to the product, either expressed or implied, including no implied warranties of merchantability or fitness for a particular purpose, except as expressly provided in this agreement. If any labor, repair, or parts replacement is required because of accident, negligence, misuse, theft, vandalism, fire, water or other peril; or because of conditions outside of specifications, including, but not limited to, electrical power, temperature, humidity or dust; or by moving, repair relocation, or alteration not performed by BRI, or by any other cause other than normal use, the warranty and maintenance obligations provided herein shall not apply.

**BRI SHALL NOT BE LIABLE FOR ANY SPECIAL, INCIDENTAL, OR CONSEQUENTIAL DAMAGES OR FOR LOSS, DAMAGE, OR EXPENSE DIRECTLY OR INDIRECTLY ARISING FROM CUSTOMER'S USE OF OR INABILITY TO USE THE EQUIPMENT EITHER SEPARATELY OR IN COMBINATION WITH OTHER EQUIPMENT, OR FOR PERSONAL INJURY OR LOSS OR DESTRUCTION OF OTHER PROPERTY, OR FROM ANY OTHER CAUSE.**

This warranty shall not be applicable to the extent that any provision of this warranty is prohibited by any Federal, state, or municipal law which cannot be preempted. This warranty gives you specific legal rights, and you may also have other rights which vary from state to state.

### **Copyright**

©1995 Boca Research, Inc. All rights reserved. No reproduction of this document in any form is allowed without permission in writing from Boca Research. Boca Research is not liable for any damages resulting from technical or editorial errors or omissions contained in this document. The information in this manual is subject to change without notice. Revisions to the product(s) described in this manual may occur at any time without prior notice.

### **Trademarks**

All Boca Research products are trademarks of Boca Research, Inc. All other references to computer systems, software, and peripherals use trademarks owned by their respective manufacturers.

**Publication Date:** August, 1995

**Printed in the U.S.A.**













**Manual Part # 9173**

**Rev. 4.1**