

# SoundExpression **EZ Installation Guide**

(SED34SRS)

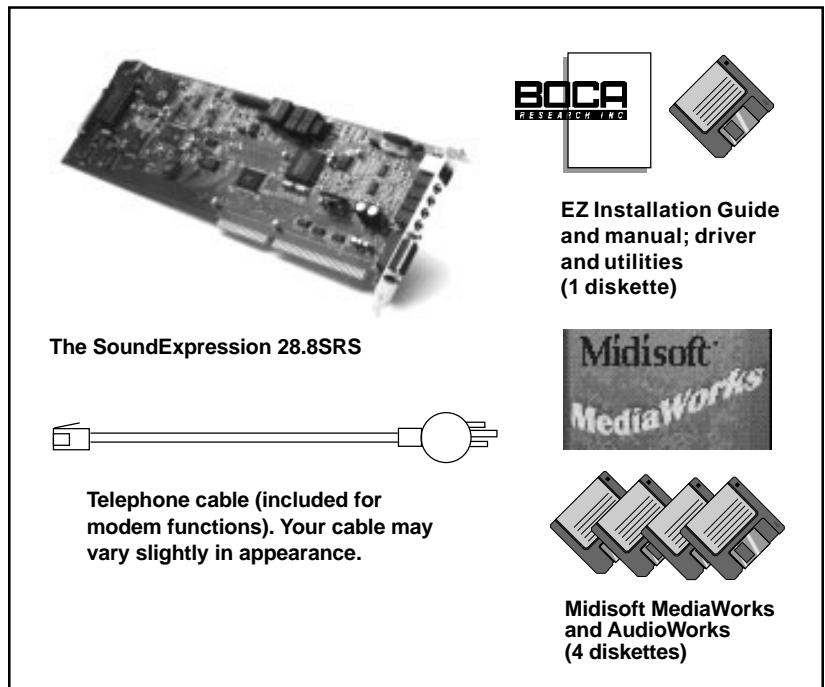

This EZ Installation Guide is designed to assist you in quickly installing your product so you can be productive within minutes. Refer to the manual for a more detailed step-by-step approach, as well as other reference information. Start here by reviewing the contents of your package.

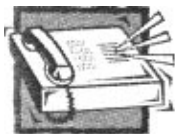

The SoundExpression 28.8SRS

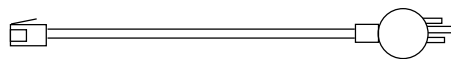

Telephone cable (included for modem functions). Your cable may vary slightly in appearance.



EZ Installation Guide and manual; driver and utilities (1 diskette)

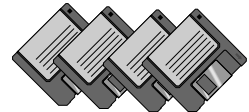

Midisoft MediaWorks and AudioWorks (4 diskettes)

In addition to the installation manuals and diskettes, introductory offers for various on-line services are included. Other notes, addenda, and product updates may appear in your package containing late-breaking product news which became available after the printing of this guide.

# Review Board Connectors

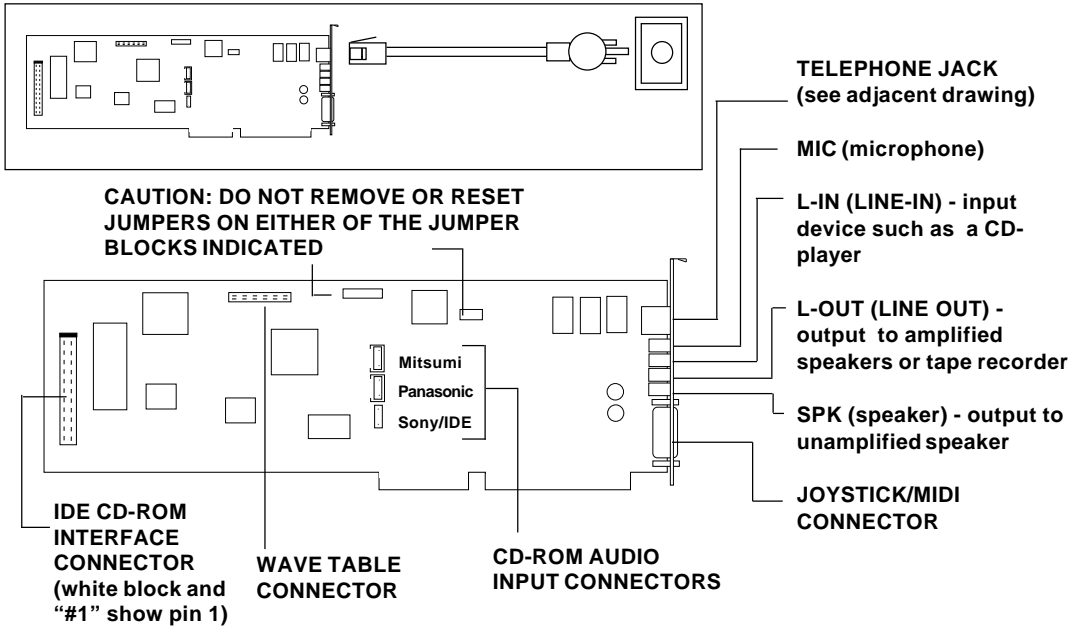

## For Non-Windows 95 Users (otherwise continue with next panel)

### If You Have an Existing Sound Card...

1. Turn on your computer and start Windows 3.1 or Windows for Workgroups 3.11, go to the Main group, select Control Panel and select Drivers. Here you will see a list of device drivers present in your computer.
2. Remove the sound card drivers from the drivers list. Highlight the sound drivers and click on "remove." **If you are not sure which drivers are for your sound card, refer to the documentation that came with your sound card or your computer system.**
3. Exit Windows, turn off your computer, and remove the installed sound card from the system.

### If You Have an Existing Modem...

If your computer came with an internal modem, you must physically remove it or disable it through your computer's BIOS setup. Consult your computer manual's documentation for specific instructions.

### DOS Users...

You may need to remove certain drivers from your CONFIG.SYS file. Now, you are ready to install the SoundExpression.

## Installing the SoundExpression Board

1. With your computer **off**, disconnect any attached devices and power cords. Remove the system cover and install the CD-ROM drive (if you are using one) into your computer. Refer to the documentation which came with your CD-ROM drive.
2. Remove the SoundExpression from its anti-static bag, handling it by its edges and retaining bracket. Be careful not to touch the edge connector or any components on the card. If you are **not** using a CD-ROM drive, skip to step 5.
3. If you are connecting your CD-ROM drive (must be IDE type) to the SoundExpression, connect the ribbon interface cable from the CD-ROM drive to the interface connector on the SoundExpression before inserting the board into your computer.

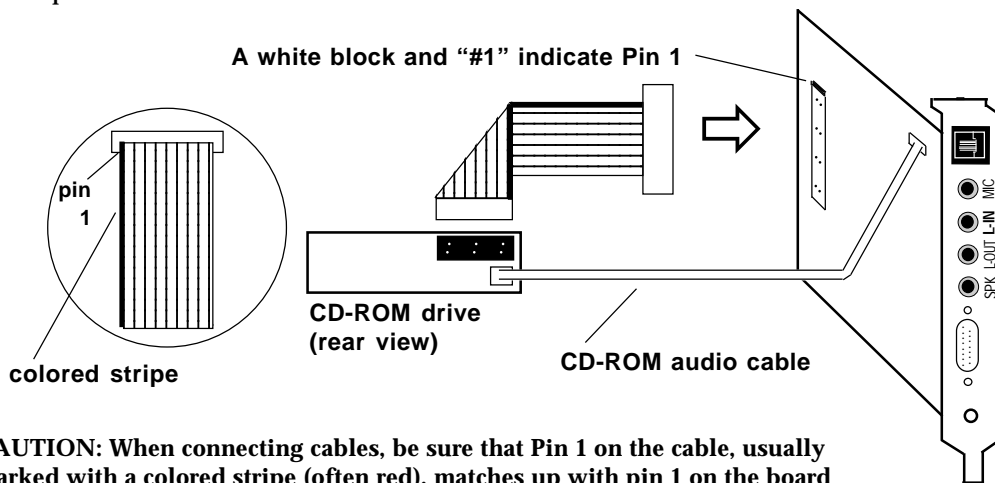

**CAUTION:** When connecting cables, be sure that Pin 1 on the cable, usually marked with a colored stripe (often red), matches up with pin 1 on the board connector. A band on the connector outline denotes Pin 1.

**NOTE:** Some CD-ROM drives have jumpers for a "MASTER/SLAVE" configuration. Make sure your CD-ROM drive is set for "MASTER" if using the CD-ROM interface on the SoundExpression.

4. If an audio cable is included with your CD-ROM drive, connect it from the CD-ROM drive to the respective CD-ROM sound input connector for Sony, Panasonic, and Mitsumi IDE CD-ROM drives. Look for the connectors labeled J3, J4, and J5 in the center of the board.

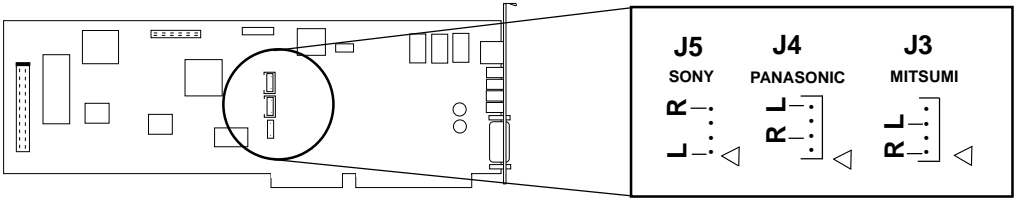

**NOTE:** ▲ indicates pin 1 for each of the audio connectors. “L” and “R” specify left and right channel for each audio connector type.

- Locate an available 16-bit expansion slot. Remove that expansion slot cover and save the screw.
- Carefully insert the board into the expansion slot you selected, applying pressure to the upper board edge until it snaps into place, being careful not to disconnect any CD-ROM or audio cables you may have attached.
- Secure the board into place by aligning its metal retaining bracket with the hole in the top edge of the system’s rear panel. Fasten the modem’s metal bracket with the screw removed in step 5.

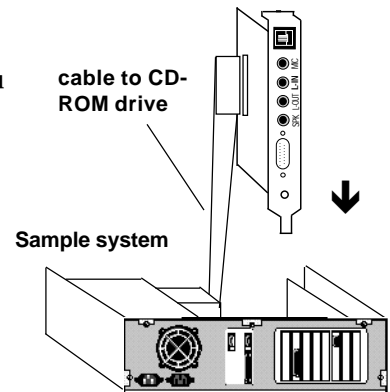

- Disconnect your present phone cord from the wall jack. Plug the country-specific end of the telephone cable that came with the SoundExpression into the wall jack, and the RJ-11 end into the phone jack on the back of the SoundExpression. **A telephone is not necessary for the proper operation of this product.**
- Attach any external audio in/out and joystick/MIDI devices. Refer to the manual for details, if necessary.
- Replace the system cover, reconnect any detached devices and power cords and turn on the computer.

**IMPORTANT NOTE:** Some computers supporting the “Plug and Play” BIOS may require a longer than normal amount of time to start up. This is because the Plug and Play BIOS searches for any and all Plug and Play devices which may have been installed; it then requires time to set up necessary system resources for these devices. Continue with the appropriate panels for Windows 95 or Windows 3.1/DOS driver installation.



## Driver Installation for Windows 95 Users

1. When the SoundExpression board is physically installed, start Windows 95 as you normally would.
2. When Windows 95 detects new hardware, it displays the “**New Hardware Found**” dialog box. Here, you are asked what (if any) driver files are associated with the new hardware.
3. From the choices given, select “**Driver from disk provided by hardware manufacturer**”.
4. Windows 95 then displays the “**Install from Disk**” dialog box. Here, you are asked for the location of the driver files. Insert the SoundExpression driver diskette in your floppy drive. Type A: (or B:) and select OK. Windows 95 will now copy files from the installation diskette. You may be asked for your original Windows 95 installation diskettes or CD.
5. Windows 95 will detect the following devices on the board. For each of these devices as listed, select “**Windows Default Driver**”.
  - **Game Port Joystick**
  - **Standard IDE/ESDI Hard Disk Controller**
6. Windows 95 will prompt you to restart your computer to finish setting up the devices on the board. Select “**NO**” so Windows 95 will continue installing the devices present on the board. Some steps may be repeated. Follow all on-screen instructions.
7. Windows 95 then displays the “**Install from Disk**” dialog box (as shown in step 4). Here, you are asked for the location of the driver files. Insert the appropriate driver diskette in your floppy drive. Type A: (or B:) and select OK. Windows 95 will now copy files from the diskette.
8. When all the new devices are installed, Windows will finish loading. When Windows 95 displays the “**Start Menu**”, select “**Start**”, then “**Shut Down**”, then “**Restart the Computer**”. This will restart Windows 95 with the newly installed drivers.

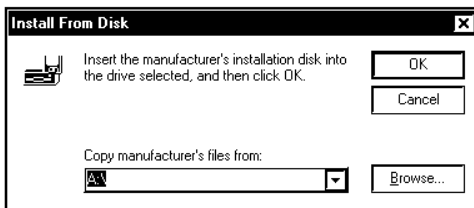

---

**NOTE:** Windows 95 will detect a number of devices on the SoundExpression board. It is not necessary to restart Windows 95 until all devices are detected and set up.

---

Windows 95 driver installation is complete. You may now install your Midisoft MediaWorks and AudioWorks applications.



## Driver Installation for Windows 3.1/DOS Users

1. If you are in Windows, exit to DOS.
2. Insert the driver diskette into your A: or B: floppy drive and type **A:\INSTALL (or B:\INSTALL)**.

The following introductory screen is displayed:

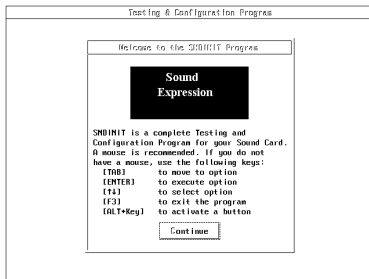

### If You Do Not Have a Mouse...

Use the following keys as described below:

[TAB]	Moves to Option.
[ENTER]	Accepts Button. Opens Combo Box for selecting options. Accepts options from combo Box.
[↑↓]	Selects Options within Combo box.
[F3]	Exits to DOS; all changes are discarded.
[ALT + KEY]	Activates a button on the Configuration and Sound-Test screen.

3. To continue select one of the following options:

**START INSTALLATION**  
**VIEW README.TXT**  
**EXIT**

4. When you "Start Installation", select a destination directory (default is C:\SOUNDEXP). Select OK.
5. If you have Windows, you will be asked for your Windows directory. If you do not have Windows installed on your system, select "NONE".
6. After confirming your selections, files are copied to your hard disk. Then you will be asked for a CD-ROM type. Select "NONE" if you do not have a CD-ROM.
7. Next you are presented with a Configuration and Sound Test screen. When you are done, select "ACCEPT".
8. You are then asked if you want to update your CONFIG.SYS file. Select "OK".
9. Lastly, you will need to power down your system, then restart. Driver installation is complete for Windows 3.1/DOS users. If you need to reconfigure the board, type SNDINIT at the \SOUNDEXP directory to run configuration. Refer to the manual for details. **NOTE: When you restart Windows, you will be asked if you want to create a Program Group for the Audio Applications. Choose "Yes".**

**Windows 3.1/DOS driver installation is complete. You may now install your Midssoft MediaWorks and AudioWorks applications.**

## Installing MediaWorks



The installation program creates a Midisoft MediaWorks group and adds a MediaWorks icon to the group. Start MediaWorks from Windows by double-clicking the MediaWorks icon. When you start MediaWorks, a MediaWorks shell appears. To start an application, double-click an item in the shell. (The specific applications included with your copy of MediaWorks may vary).



**If you are running Windows 95**, select **Start**, then **Run**. Make sure the correct path appears in Command Line for Installation Program (typically **A:SETUP**). Then, select **OK**.

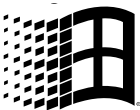
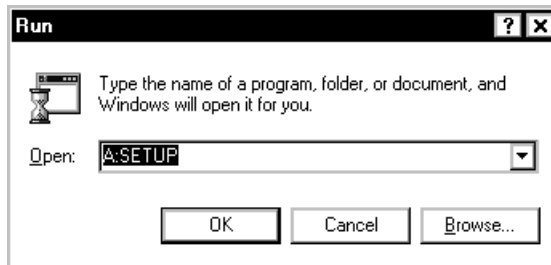

**If you are running Windows 3.x**, go to Program Manager and select **File**, then **Run**. Then type **A:SETUP** and select **OK** to begin installation.

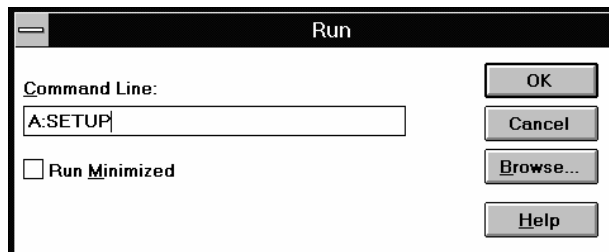

## WaveTable Card Installation

The SoundExpression will support a Wave Blaster™ compatible wave table card. The Wave Table card contains sound samples of actual instruments. When MIDI music is played using the wave table card, the music will sound like real instruments.

### Windows 3.1 Users

To set up the Wave Table Card:

1. Start Windows as you normally would.
2. Select the Midimapper icon in the Windows Control Panel.
3. Select MPU-401 in the Midimapper dialog box.

### Windows 95 Users

1. Start Windows 95.
2. Select Control Panel, then the MIDI tab.
3. Next, select "MPU-401 Compatible".

**NOTE:** Wave Table cards vary in type and size and may not resemble the one suggested here. **WARNING:** The wave table card **MUST NOT COVER** any of the circuitry highlighted as shown.

**NOTE:** To use internal FM synthesis, select "...FM Synthesis" at the MIDI tab.

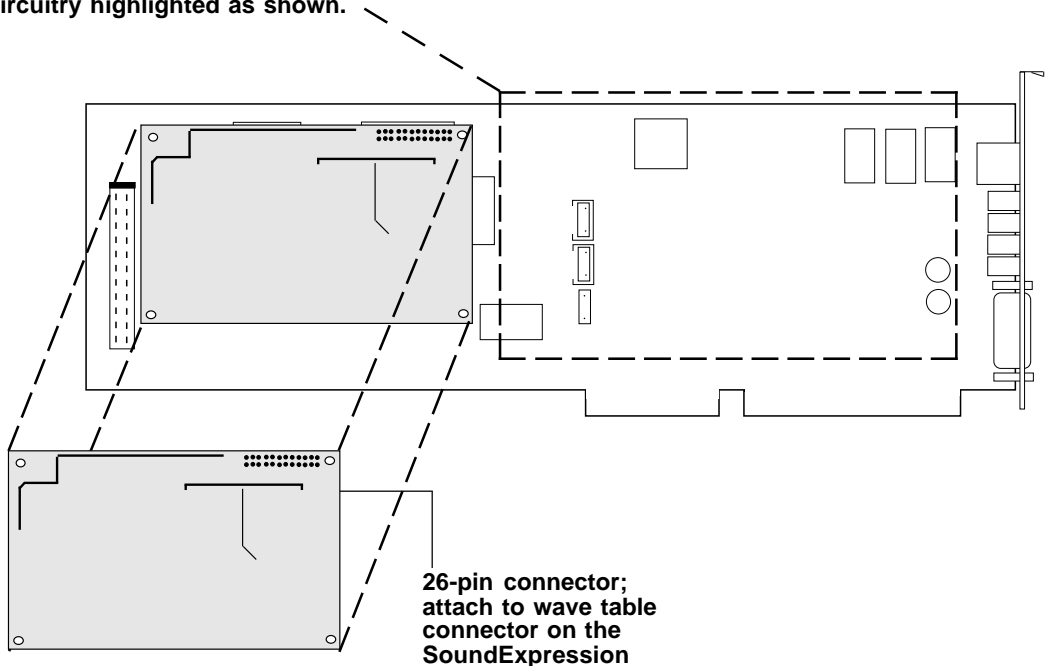



## DECLARATION OF CONFORMITY

(In accordance with EN 45014)

We,

Boca Research, Inc.  
1377 Clint Moore Road  
Boca Raton, FL 33487

***declare under our sole responsibility that the product,***

Type of Equipment: Optical Modems  
Model Numbers: 'SEXX34SRS'

***to which this declaration relates is in conformity with the following standards or other normative documents:***

Safety: The Product complies with the requirements of the low voltage directive 73/23/EEC, EN 60950 (1992), A1 & A2

EMC: EN 55022 (1993) Class B  
EN 50082-1 (1992)  
IEC 801-2 (1991), 4kV CD; 8kV AD  
IEC 801-3 (1984), 3 V/m  
IEC 801-4 (1988), 0.5 kV Signal Lines,  
1 kV AC Power Lines

***following the provision of EMC directive 89/336/EEC***

Boca Raton, Florida USA

Signature and Date: available on request

Typed Name and Title: available on request

European Contact: **Boca Research Holland**



### CAUTION:

Telecommunications voltages and currents can exceed the limits of safety extra low voltage (SELV), resulting in personal injury. Do not touch any components on the modem's printed circuit board when power is applied, or the telephone cable is plugged in.

Avoid installing, handling the telephone cable, or changing the jumper settings on the modem during any weather activity where lightning strikes may occur.

This unit is intended for installation in computing devices that are non-operator accessible. Installation is to be performed by qualified service personnel only

**NOTE: This product does not support pulse dialing.**

---

**Copyright**

©1996. Boca Research, Inc. All rights reserved. No reproduction of this document in any form is allowed without permission in writing from the Boca Research, Inc. Boca Research, Inc. is not liable for any damage resulting from technical or editorial errors or omissions contained in this document. The information in this manual is subject to change without notice. Revisions to the product(s) in this manual may occur at any time without notice.

**Trademarks**

All Boca Research products are trademarks of Boca Research, Inc. All other references to computer systems, software, and peripherals use trademarks owned by their respective manufacturers.

**Publication Date:** April, 1996

Printed in the U.S.A. (SEALLEZD.PMS)

***On-Line Support!***

***CompuServe: GO BOCA***

***Internet: email:***

***support@boca.org***

***on the World Wide Web: http://***

***www.boca.org***





PN#: LB596  
Rev. 1.0