

Racore Companions™ Drive Two Plus (Model 1500/1501) Installation Instructions

Drive Two Plus

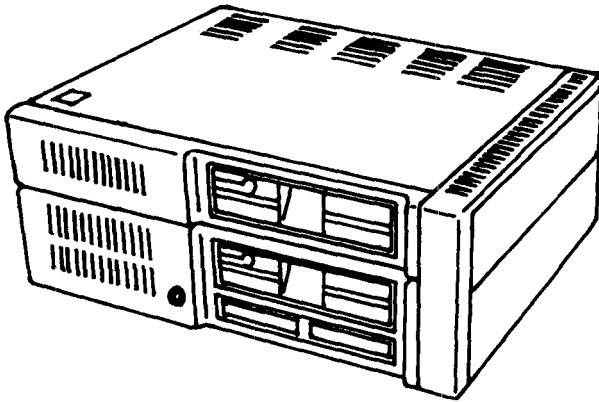

If your IBM PCjr has not been set up at this time, do so before installing this product.

This carton contains the following:

- Top Assembly with Diskette Drive and Power Supply.
 - Side Board Assembly.
 - Transformer with power cords.
 - Racore Diskette Drive Signal Cable.
 - Racore Software Diskette and Documentation.
- If Model 1501 ● DMA Floppy Controller Board and Cable.

If any item is missing or damaged, notify place of purchase.

*IBM, IBM PC, and IBM PCjr are registered trademarks of International Business Machine Corporation
Racore and Racore Companions are trademarks of
Racore Computer Products, Inc.*

**Racore Computer
Products, Inc.**
Corporate Office
170 Knowles Dr.
Los Gatos CA 95030

Federal Communications Commission Radio Frequency Interference Statement

Warning: This equipment has been certified to comply with the limits for a Class B computing device, pursuant to Subpart J of Part 15 of FCC Rules. Only peripherals (computer input/output devices, terminals, printers, etc.) certified to comply with Class B limits may be attached to this device. Operation with non-certified peripherals is likely to result in interference to radio and TV reception.

Instruction to User

This equipment generates and uses radio frequency energy. If not installed and used properly in strict accordance with the operating instructions, it may cause interference to radio and television reception. It has been tested and complies with the limits for a Class B computing device, pursuant to Subpart J of Part 15 of FCC Rules to provide reasonable protection against such interference when operating in a residential installation.

If this equipment does cause interference to radio or television reception, which can be determined by turning the equipment off and on, the user is encouraged to try to correct the interference by taking one or more of the following measures:

- Reorient the receiving antenna.
- Relocate the equipment with respect to the receiver.
- Move the equipment away from the receiver.

- Plug the equipment into a different outlet so the equipment and receiver are on different branch circuits.
- Ensure that side assembly mounting screws and all cables are tightly secured. **Do Not Overtighten.**
- It is necessary to use shielded, grounded cables with all peripherals. Make sure your **Non-Racore peripheral** equipment has grounded cables.

If necessary, consult your dealer service representative for additional suggestions.

The manufacturer is not responsible for any radio or TV interference caused by unauthorized modifications to this equipment. It is the responsibility of the user to correct such interference.

Caution

This product is equipped with a UL listed and CSA-certified plug for user safety. It is to be used in conjunction with a properly grounded, 115 VAC receptacle to avoid electrical shock.

Caution

This system may be damaged by attaching or detaching boards or peripherals from the system with the power on.

Racore Drive Two Plus Software Diskette Directory

The **Racore** Software directory provided in this package contains 13 files. They are:

- VERSION X.X
- JRDMAON2.EXE
- SETDCLK2.EXE
- POWDCLK2.EXE
- PCVIDMA2.COM
- MDSKDMA2.SYS
- SPEEDMA2.COM
- JRVIDMA2.SYS
- PARK.EXE
- AUTOEXEC.BAT
- READ.ME

This is a complete listing of all **Racore** software supplies for ALL systems.

The File: PARK.EXE is not intended for use on the Racore Drive Two Plus

Technical Support

Racore Technical Services personnel are available to assist with difficulties that may arise during installation of your system.

In order for us to handle your call in a prompt and efficient manner, we request that you make the following preparations **BEFORE** you make your call:

1. Carefully read your instruction manual.
2. Have your system set up in front of you.
3. Have your system serial # and instruction manual ready.
4. You will need the original DOS and Racore Disks as well as several blank Disks.
5. Please have your questions ready or written down.

Technical Services personnel are available from 8:30 a.m. to 4:30 p.m. Mountain Standard Time, Monday through Friday.

Installation of Racore Drive Two Plus

The following is a step by step set of instructions for installation of the **Racore Drive Two Plus**.

- Note:
- If you purchase the **Racore Memory Expansion Option**, you should complete the **Memory Expansion Installation** before you start this installation.
 - If you have additional peripheral equipment that attach to the side bus on your PCjr, you may have to alter address locations, please consult the address considerations chapter of these instructions.

- 1 Turn your IBM PCjr's power off.
- 2 Turn all external option power off (printer, TV, etc.).
- 3 Unplug the power cords for the IBM PCjr and all options from the wall outlets.

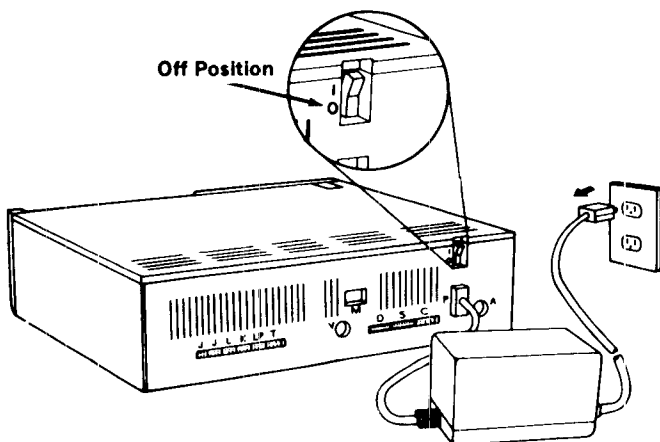

- 4** Turn your IBM PCjr so the rear is toward you.

Caution

Serious shock hazards exist within the cover of the IBM PCjr. Do not open the cover unless you have unplugged your IBM PCjr's power cord from the wall outlet.

Warning

After turning your IBM PCjr off, allow 5 minutes for cooling to take place before removing the cover.

- 5** Insert a flat-blade screwdriver into the slots between the top cover and case. Gently twist to lift cover.
- 6** Remove the top cover by lifting it up and away from the front of the IBM PCjr.
If you purchased the Drive Two Plus with DMA* Option installed (Model 1501) then proceed directly to step 21 on Page 12.

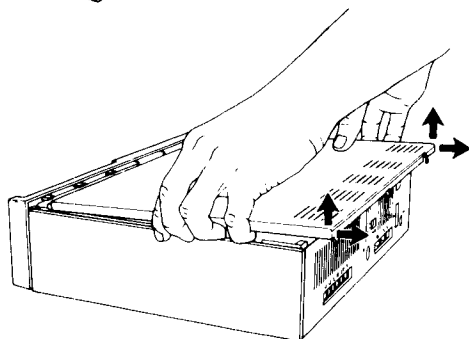
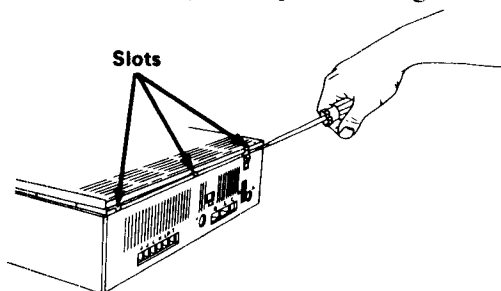

*DMA is an acronym for Direct Memory Access. See "Products for your PCjr." section in rear of manual for details.

Installation of Racore Drive Two Plus (model 1500)

- 7 Disconnect and remove the IBM PCjr diskette drive signal cable from the diskette drive and the diskette drive adapter.

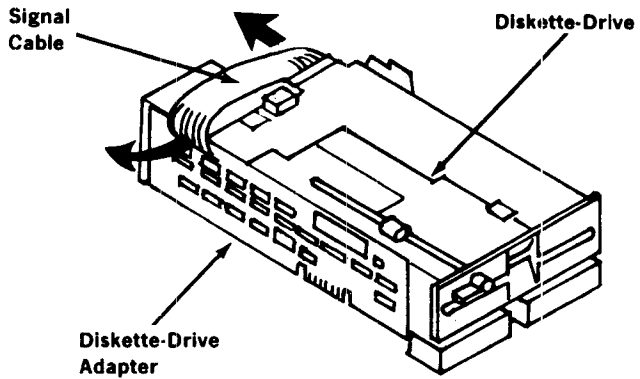

- 8 Connect the **Racore** diskette drive signal cable to the diskette drive. Be sure to align the guide correctly.

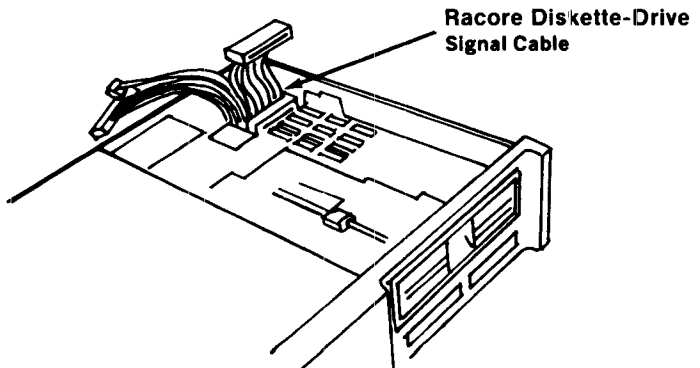

- 9 Plug the **Racore** diskette drive signal cable into the connector on the diskette drive adapter. Be sure to align the pins and holes correctly.

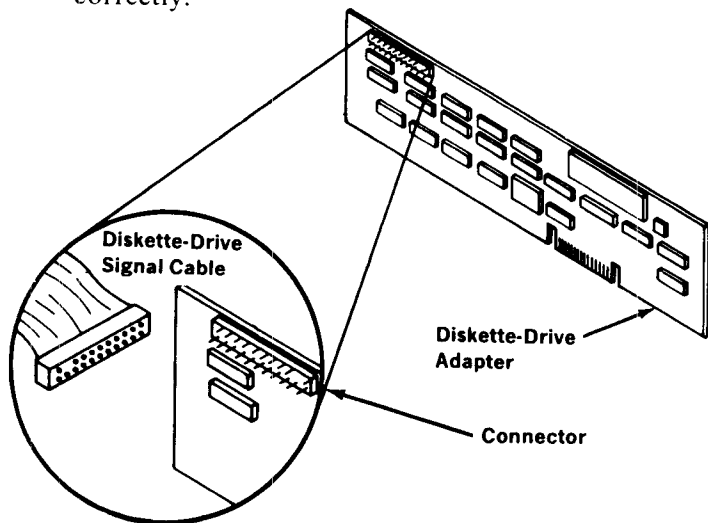

- 10 Place the **Racore Drive Two Plus Top Assembly** on the IBM PCjr. Pass the 2 remaining ends of the **Racore** diskette drive signal cable through the hole behind the diskette drive of the Top Assembly. Slide the Top Assembly forward. Press down on the rear of the Top Assembly until it snaps into place.

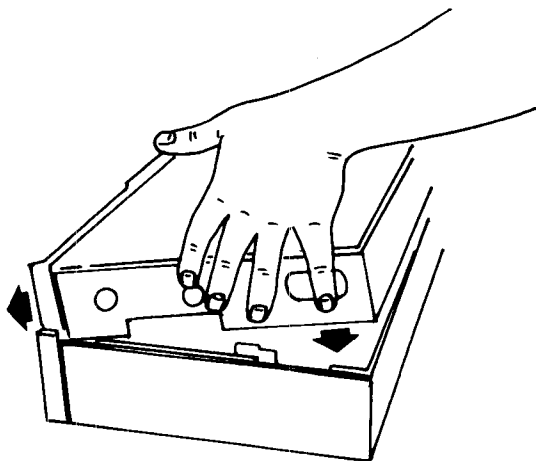

- 11** Plug the **Racore** diskette drive signal cable to the diskette drive in the **Racore** Top Assembly. Be sure to align the guide correctly.

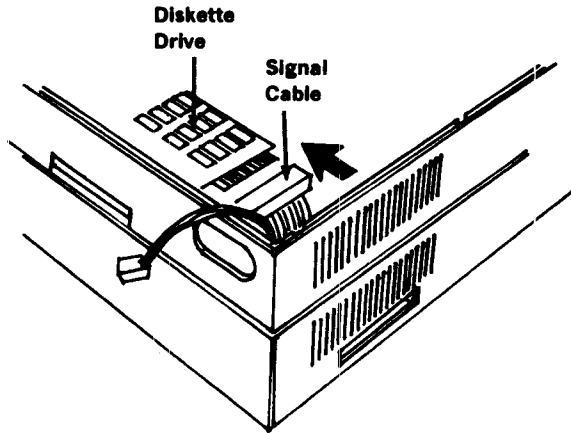

- 12** Turn your IBM PCjr so the right side is toward you. Remove the option attachment cover.

Note:

- It may be necessary to gently pry the cover off by inserting a screwdriver between the option attachment cover and the side of your IBM PCjr.

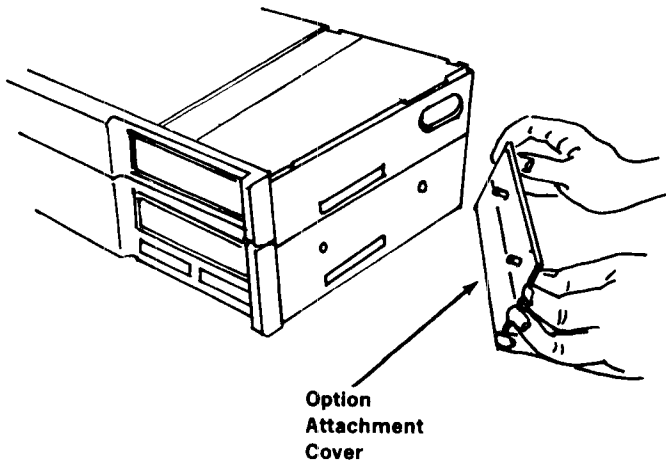

- 13** Position the **Racore** Side Assembly so the mounting holes and attachment slot line up with the mounting pins and attachment connector. Press the **Racore** Side Assembly into place. Be careful not to bend or break the pins on the **PCjr** I/O connector. **Do Not Force The Side Assembly Into Place.**

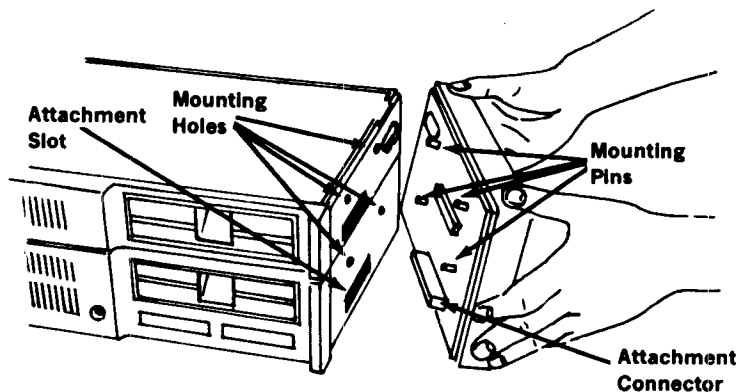

- 14** Install and tighten the four mounting screws until they are snug but **do not overtighten** screws.

Note: Use a medium flat-blade screwdriver.

- 15** Replace the option attachment cover. Make sure it is pressed firmly into the mounting holes.

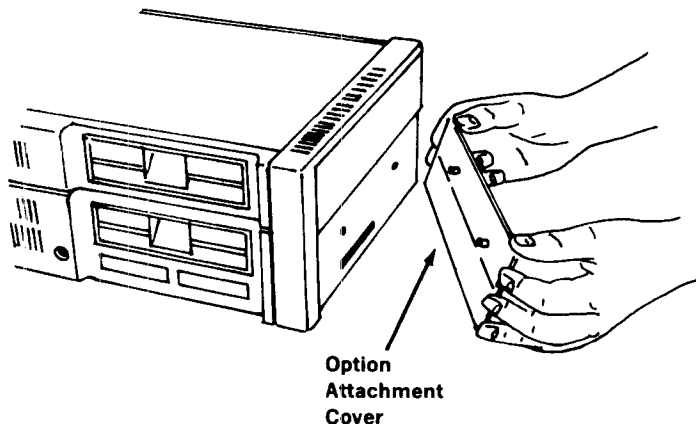

16 Plug the diskette drive signal cable into the connector on the **Racore** Side Assembly. Be sure to align the pins and holes correctly.

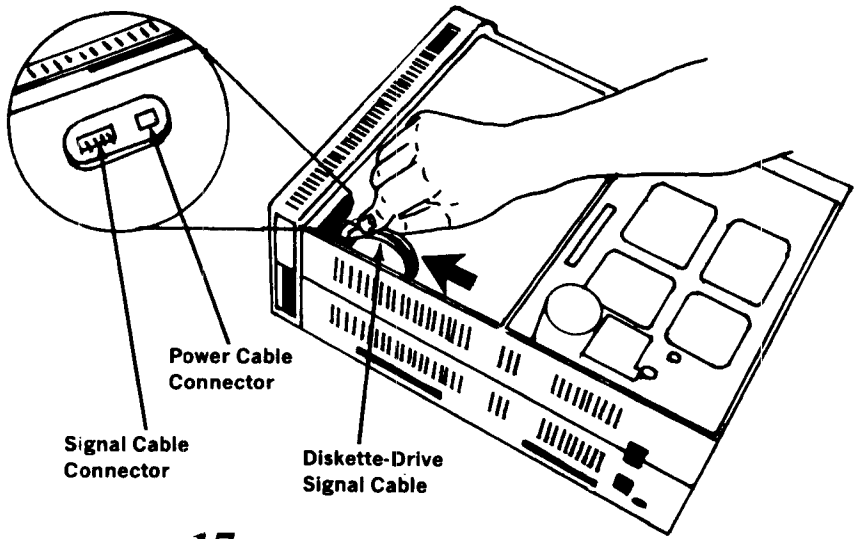

17 Plug the Side Assembly power cable into the connector on the **Racore** Side Assembly. Be sure to align the pins and holes correctly. The connector should snap into place.

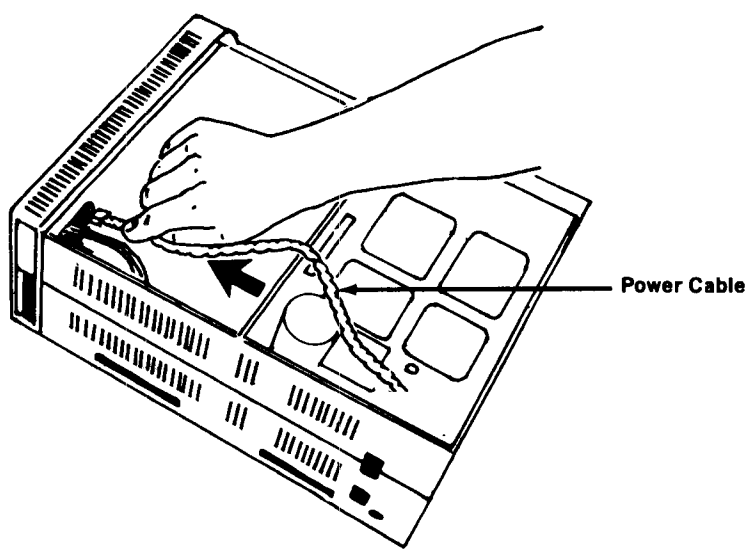

- 18** Replace the top cover by placing it on the **Racore** Top Assembly. Slide it forward until the top cover and front of the **Racore** Top Assembly fit together. Press down on the rear of the top of cover until it snaps into place.

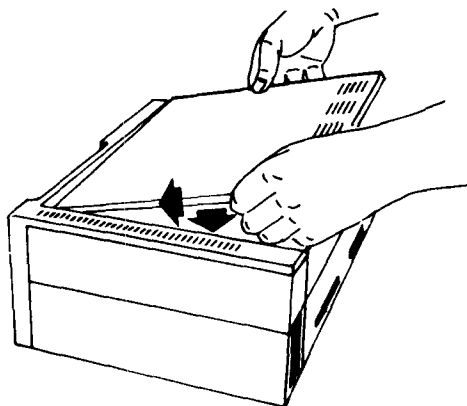

- 19** Remove the shipping protector from the diskette drive.

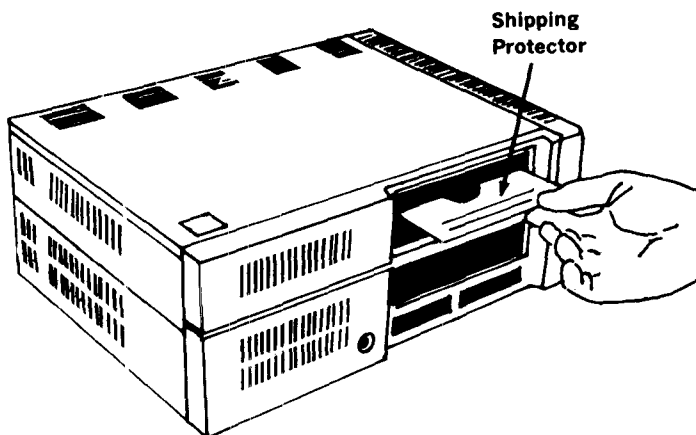

- 20** Plug the IBM PCjr and the **Racore Drive Two Plus** power cords into wall outlets.

Both black transformers must be plugged into the new system.

Your **Drive Two Plus (Model 1500)** installation is now complete.

Installation of Racore Drive Two Plus with DMA Option (Model 1501)

- 21** Disconnect and remove the IBM Diskette Drive Signal Cable from the IBM PCjr diskette drive. It is not necessary to disconnect the signal cable from the IBM PCjr Diskette Drive Adapter for removal.

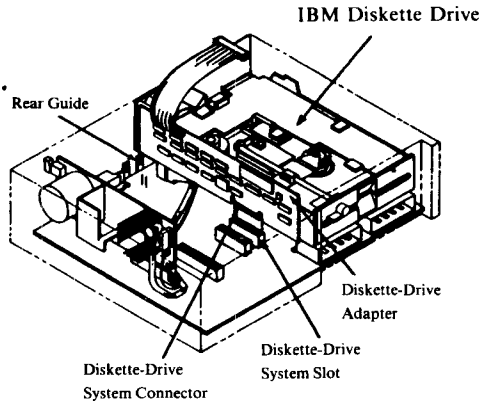

- 22** Remove the IBM PCjr Diskette Drive Adapter and attached IBM Diskette Drive Signal Cable from your PCjr by gently lifting up the Diskette Drive Adapter card. Replace with the **Racore DMA Floppy Disk Adapter** provided with your **DMA Option Package**. Install in the slot closest to the IBM Diskette Drive.

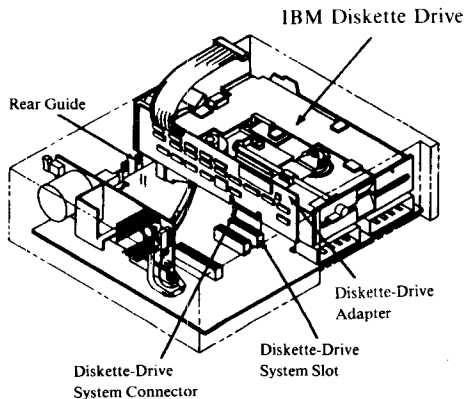

- 23** Your **Racore DMA Option** contains two cables; the **Racore DMA Diskette Drive Signal** cable and the **Racore DMA 10 Conductor Signal** cable.
 (These cables may already be connected to the **Racore Diskette Drive Adapter**.)

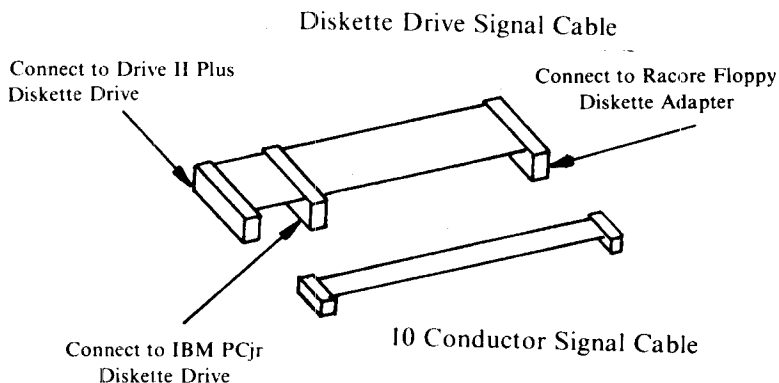

- 24** Plug the **Racore Diskette Drive Signal Cable** into the **IBM PCjr Diskette Drive**.

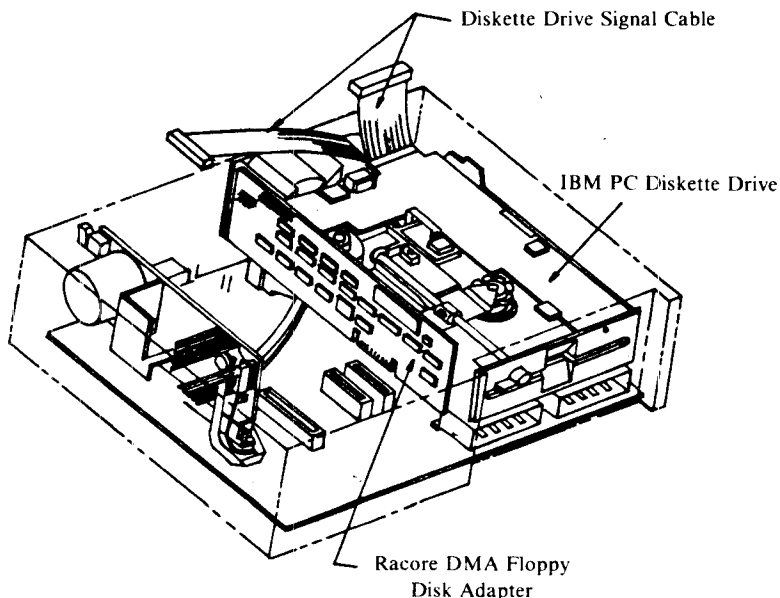

25

Plug the **Racore** Diskette Drive Signal Cable into the longer of the two connectors on the **Racore DMA Floppy Disk Adapter**. Plug one end of the **Racore DMA 10 Conductor Signal Cable** into the shorter connector on the **Racore DMA Floppy Disk Adapter**. It does not matter which end of the 10 Conductor Cable is plugged into the adapter. Be sure, however, to align the pins and holes correctly.

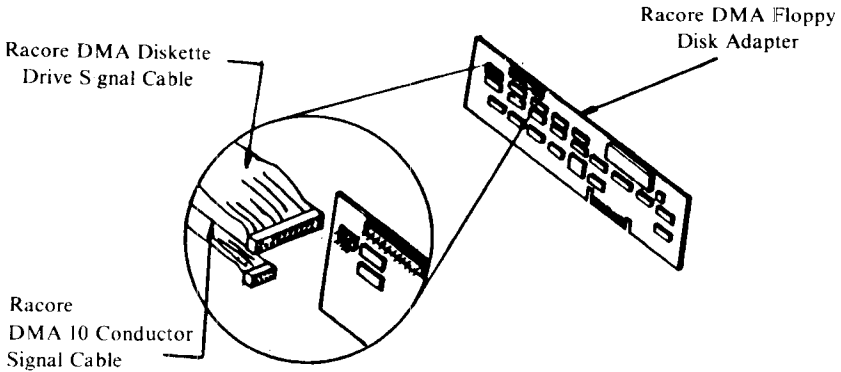

26

Before placing the **Racore Drive Two Plus Top Assembly** on the IBM PCjr, be sure that the 10 Conductor Cable is routed around the DMA Floppy Disk Adapter to avoid being pierced by the underside of the Top Assembly as illustrated below.

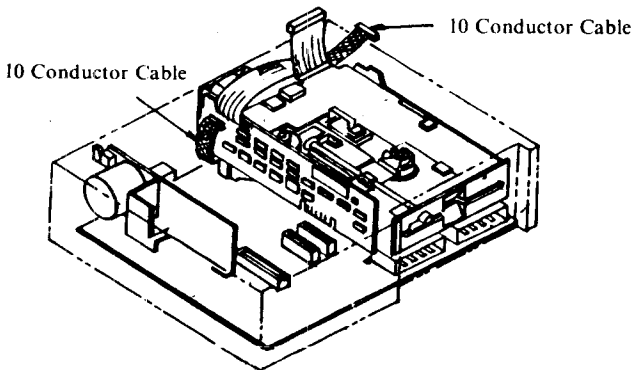

- 27** Place the **Racore Drive Two Plus Top Assembly** on the IBM PCjr. Pass the 2 remaining free ends of the **Racore** signal cables through the hole behind the diskette drive of the Top Assembly. Slide the Top Assembly forward. Press down on the rear of the Top Assembly until it snaps into place.

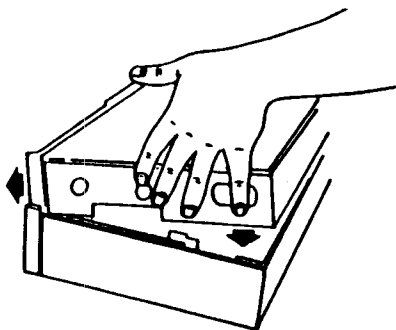

- 28** Plug the **Racore DMA** diskette signal cable on to the diskette drive in the **Racore** Top Assembly. Be sure to align the guide correctly.

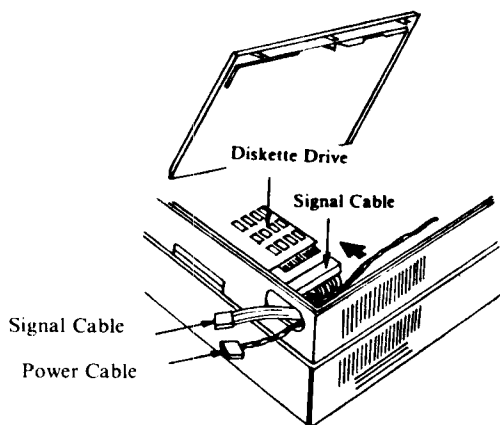

29

Remove attachment cover.

Position the **Racore Side Assembly** so the mounting holes and attachment slot line up with the mounting pins and attachment connector. Press the **Racore Side Assembly** into place. Be careful not to bend or break the pins on the **PCjr I/O Connector**, **Do Not Force The Side Assembly Into Place.**

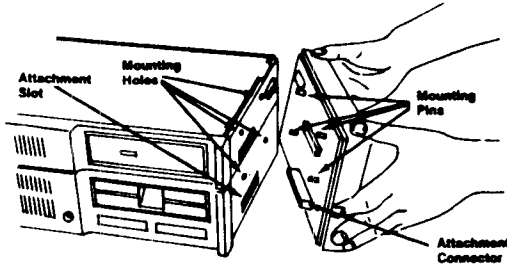

30

Secure the four mounting screws until they are snug but **DO NOT OVERTIGHTEN SCREWS.**

Note: Use a medium sized flat-blade screwdriver.

31

Replace the option attachment cover. Make sure it is pressed firmly into the mounting holes.

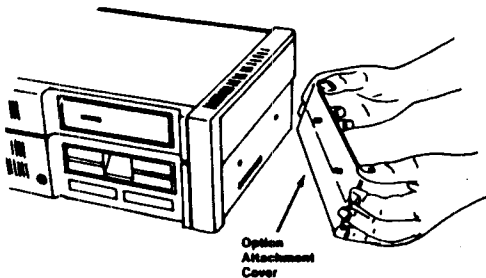

- 32** Plug the side assembly power cable and the 10 conductor signal cable connectors on the **Racore Side Assembly**. Be sure to align the pins and the holes correctly. The power cable should snap into place

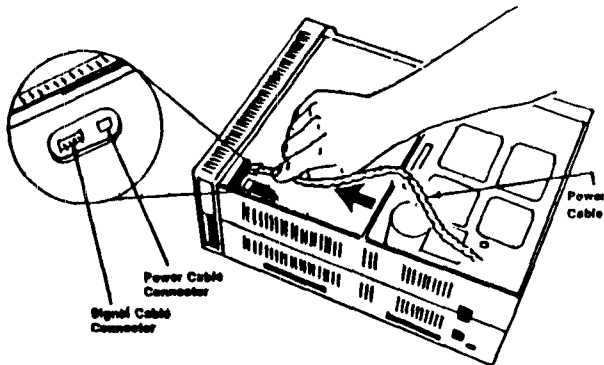

- 33** Replace the top cover by placing it on the **Racore Top Assembly**. Slide it forward until the top cover and front of the **Racore Top Assembly** fit together. Press down on the rear of the top cover until it snaps into place.

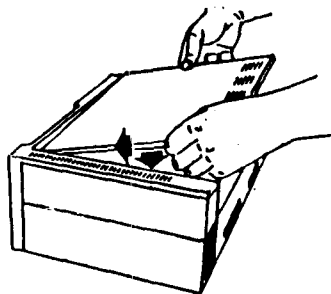

Refer back to Steps 19 & 20 on Page 11.
Your Drive Two Plus with DMA Option
(Model 1501) installation is now complete.

Instructions

Racore Software Installation

Making Backup Copy of Racore Software Diskette *.

1 Flip the toggle switch on the back of the Side Assembly to PCjr Mode (outward).

2 Insert your Disk Operating System (DOS) working diskette into Drive A. (Bottom Drive)

3 Turn your PCjr on.

- You will see something similar to this on your screen:

Current date is 1-01-1980

Enter new date:

4 Press ENTER Key twice

- You will see this on your screen:

A>

5 Type DISKCOPY A: B: Press ENTER.

- You will see this on your screen:

Insert source diskette in drive A:

Insert target diskette in drive B:

Strike any key when ready

6 Remove your DOS working diskette from diskette drive A.

7 Insert the **Racore** Software Diskette in drive A.

***Warning:** Improper insertion of the diskette into the diskette drive could cause damage to the heads. This type of damage is not covered under the **Racore** warranty.

- 8 Properly insert a blank diskette in drive B. (Top Drive)
- 9 Press any key
 - When the backup copy is complete, you will see this on your screen:
Copy complete
Copy another (Y/N)?
- 10 Remove your **Racore** Software Diskette from drive A.
- 11 Insert your DOS working diskette in drive A.
- 12 Type N.
 - You will see this on your screen:
A>
- 13 Verify that you have **Racore** copy in Drive B and DOS copy in Drive A, then proceed to step 14

Take Racore Master Software Diskette And Put It Away For Safe Keeping. Always Use The Backup Copy.

Setting The Clock/Calendar

14 Type B:SETDCLK2 Press ENTER

- You will see something similar to this on your screen:

Current date is 9-30-1982
Enter new date:

15 Enter the current date. Press ENTER.

- You will see this on your screen:

Current time is 0:09:28
Enter new time:

16 Enter the current time (HH:MM) Press ENTER

- You will see this on your screen:

A>

17 Type COPY B:POWDCLK2.EXE Press ENTER

- You will see this on your screen:

A>

Your Clock/Calendar Is Now Permanently Set And The Clock's Software Is Installed On Your DOS Working Diskette.

Making Your PCjr Video Compatible With PC Video

18 Type COPY B:PCVIDMA2.COM Press ENTER

- You will see this on your screen:

A>

This File Is Now Installed On Your DOS Working Diskette.

Creating Or Editing An Autoexecute File

Establishing this file eliminates the need to enter time and date each time you boot up your system.

19 Type **EDLIN AUTOEXEC.BAT** Press **ENTER**

- You will see this on your screen:

New File

*

or

End of file

*

20 Type **i** Press **ENTER**

- You will see this on your screen:

*1:**

21 Type **PCVIDMA2** Press **ENTER**:

- You will see this on your screen:

*2:**

22 Type **POWDCLK2** Press **ENTER**

- You will see this on your screen:

*3:**

23 Hold the **CTRL** Key down while depressing the **C** key.

- You will see this on your screen:

*

24 Type E Press ENTER

- You will see this on your screen:

A>

The New Autoexecutive File Is Now Installed On Your DOS Working Diskette.

25 Type COPY B:JRVIDMA2.SYS Press ENTER

- You will see this on your screen:

A>

This file is now installed on your DOS working disk.

26 Type EDLIN CONFIG.SYS Press ENTER

- You will see this on your screen:

New file

*

or

End of file

*

27 Type `i` Press ENTER

- You will see this on your screen:

`I: *`

28 Type `DEVICE=JRVIDMA2.SYS` Press ENTER

- You will see this on your screen:

`2: *`

29 Hold CTRL key down and press C.

- You will see this on your screen:

`*`

30 Type `E` Press ENTER

- You will see this on your screen:

`A>`

Your normal mode CONFIG.SYS file is now installed on your DOS working disk.

31 Depress CTRL, ALT, DEL keys.

- You will see this on your screen:

`A> PCVIDMA2`

`A> POWDCLK2`

`A>`

`A>`

Your **Racore** software is now installed on your DOS working disk.

If you boot your system with this DOS disk you will be operating in the Normal mode. If your switch is in the JR position, you will be in JR Normal mode. If your switch is in the PC position, you will be operating in PC Normal mode.

Racore Software Options

Your **Racore** Software disk includes several convenient operating and data handling modes for your PCjr. It is important that you understand why you have so many options, when to use different options, and how to use them.

A. Why you have options

Before you can appreciate why you have so many memory options, you need to understand how your PCjr utilizes memory. The "enhanced" PCjr has 128K of internal RAM memory. This memory must be used for storing video buffers, DOS files and the software files you wish to use. Unless you instruct your PCjr differently, the last 16K of your internal 128K of memory is used for the video buffer. (See fig. 1) If you add additional memory to your system (the Racore memory expansion or IBM's memory expansion), this buffer creates a "hole" in your available memory. (See fig. 2) When this condition exists, DOS will not recognize the additional memory.

Figure 1.
Standard memory utilization

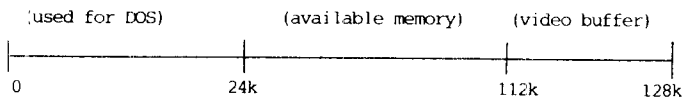
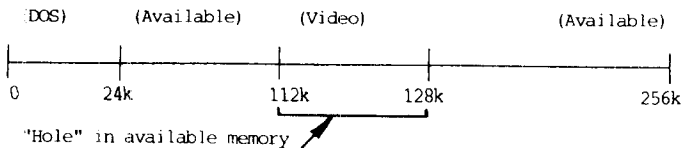

Figure 2.
Additional 128K of Memory added to PCjr's 128K
(standard mode).



The software that **Racore** provides allows movement of the video buffer so it immediately follows the DOS files. (See fig. 3)

The file name is PCVIDMA2 in PC mode and JRVIDMA2 in the PCjr mode.

Figure 3.

Additional 128K of memory additional to PCjr's 128K (normal mode)

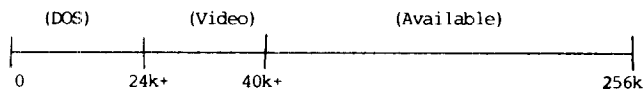

As you can see, installation of **Racore's** software eliminates the "hole" in your memory bank. This allows you to run programs that require additional memory.

If you understand the concept of moving the video buffer, the rest should be easy to follow. Your PCjr is actually more powerful than a PC in the area of graphics capabilities. However, if you want to utilize these expanded graphics features in the PCjr mode, your video buffer must grow in size from 16K to 32K. (See fig. 4) If you want to use expanded graphics with additional memory, you must instruct your PCjr to reserve 32K for a video buffer. This is done using JRVIDMA2 / E in Jr mode.

Figure 4.

Additional 128K of memory added to PCjr's 128K (enhanced mode)

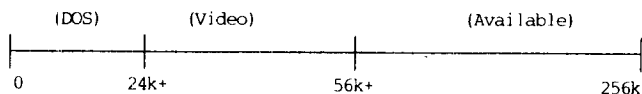

Your PCjr's internal memory is slower than the additional memory provided by **Racore's** expansion board. Some PC software will operate at 3 times the speed on **Racore's** memory.

If you want to take advantage of this faster operation in the PCjr Mode, you may reserve the entire PCjr memory for DOS and video buffer. (See fig. 5) Operating in this mode gives you all the enhanced graphics capabilities you had if you reserved a 32K video buffer plus page switching features. Page switching is a feature that allows you to create up to four 32K pages of expanded graphics in your video buffer. This feature is necessary when creating animation on multiple graphics pages.

Figure 5.

Additional 128K of memory added to PCjr's 128K (compatible mode)

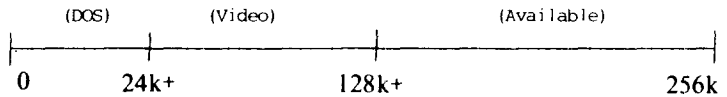

B. Definitions of options

We have now defined 4 modes of memory utilization available to you in the PCjr mode, if you add additional memory to your PCjr's 128K.

1. Standard mode - is in effect when DOS is loaded with no special instructions or software. It can be used with all PCjr software but leaves a "hole" in memory if you attempt to run software utilizing additional memory.
2. Normal mode - moves a 16K video buffer back so you get maximum utilization of available memory. Not compatible with enhanced graphics.
3. Enhanced mode - moves a 32K video buffer back so you get maximum utilization of available memory when operating with enhanced graphics.

- 4. Compatible mode - Reserves all 128K of PCjr memory for DOS and video. Allows use of enhanced graphics and page switching and provides fast operation but sacrifices memory.

If the only difference between the IBM PC and the IBM PCjr was memory, these four options would be all that you needed. However, there are other differences in the two systems and these relate to keyboard and video commands. **Racore** has modified these commands with hardware changes in our side assembly. The switch we provide allows you to make these changes when operating in the PC position (switch inward) while still being able to operate as a PCjr in the jr position (switch outward).

Since PC software does not utilize enhanced graphics, there is no need for a 32K video buffer option. The only options you have in PC mode are normal mode and compatible mode. Since you cannot use extended graphics in the PC mode, we call the compatible mode **SPEEDMA2** when used for PC applications.

The following table details the memory options you have with **Racore** hardware and software.

	PCjr mode	PC mode
Standard	X	
Normal	X	X
Enhanced	X	
Compatible (Speeder)	X	X

C. When to use options

Don't let all these available operating modes frighten you. If you follow these simple rules you won't be confused.

- 1. When operating software written for the IBM PC, operate in the PC mode (switch on **Racore** side unit is inward.)

2. When operating software specifically designed for the PCjr, follow the directions included with the software to determine how to install Normal, Enhanced or Compatible device drivers, and operate in PCjr mode.

If you want to operate in Standard jr mode, boot your system with an unmodified DOS disk.

If you want to operate in Normal jr mode, Enhanced jr mode, or Compatible jr mode, you must install the proper device drivers in a CONFIG.SYS file. The proper commands are listed below:

Mode	Specify	User Memory	PCjr Video Memory	Video Modes Allowed
Normal	DEVICE=JRVIDMA2.SYS	Maximum for Normal Applications	16K	All text modes 160 x 200 16 color 320 x 200 4 color 640 x 200 2 color 1 graphics page
Enhanced	DEVICE=JRVIDMA2.SYS /E	Maximum for Enhanced Applications	32K	All text modes 160 x 200 16 color 320 x 200 4 color 640 x 200 2 color 320 x 200 16 color 640 x 200 4 color 1 32K pages 2 16K pages
Compatible	DEVICE=JRVIDMA2.SYS /C	Applications Use Only the Expanded Memory	96K	All text modes 160 x 200 16 color 320 x 200 4 color 640 x 200 2 color 320 x 200 16 color 640 x 200 4 color 3 32K pages 6 16K pages

See section F of these instructions for installation of CONFIG.SYS files.

In the PC mode, you can execute the program SPEEDMA2 and increase the speed of execution of your PCjr by up to 3.5 times. This program need only be executed once (twice for DOS version 1.1) at system startup. If you want to operate in the Speeder mode, you should install SPEEDMA2 in the AUTOEXEC.BAT file after PCVIDMA2 on your DOS disk, (see section on AUTOEXEC file execution).

*PCVIDMA2 should always be executed prior to any other programs when your system is in PC mode.

E. How to Use Memory Disk Options

The Memory device driver, when installed, transforms part of your PCjr memory into a “logical” disk. Thus, you have another disk in which to save and load programs and files. Programs and files that are stored in the memory disk are treated just like programs and files on a real diskette except that they are saved and loaded much faster and (unfortunately) if you power off your computer they will be lost. Thus, if you want to save information from your “memory” disk, make sure you COPY the files/programs to a real diskette before you power off your computer or perform a system reset (Ctrl/Alt/Del).

The Memory Disk is referenced by the diskette drive identification of “C”. Most of the DOS diskette commands will apply to the memory disk such as DIR, COPY, ERASE, CHKDSK, etc.; and all applications will access programs and files from the memory disk merely by prefixing the file-name with the drive ID of “C:”. Of course since the disk is in memory, you effectively have a single diskette always loaded that is already FORMATTED. You can think of it as a “hard” file in memory.

To install the Memory Disk device driver, you can create or edit the DOS configuration file (CONFIG.SYS) on your DOS working diskette (see section F).

The Memory Disk device driver is file named MDSKDMA2.SYS

You can specify the amount of memory you want to allocate for your memory disk in K (1024) byte increments as a parameter after the device driver filename. The number must be in the range of 24 to 512 or the memory disk will be allocated the default size of 64K bytes.

For example:

```
DEVICE=MDSKDMA2.SYS /128
```

will create a memory disk with the capacity for 128K bytes, or 131,072 characters.

DEVICE=MDSKDMA2.SYS /88

creates a memory disk with the capacity of 88K bytes.

Part of the memory disk (approximately 5K) is used for directory space, so all 128K bytes (or 88 bytes) are not available for programs and files.

The following illustrates the PCjr Mode memory configuration for a Memory Disk of 100K and the Expanded Memory device driver operating in "Normal Mode" with an additional 128K memory added to PCjr's 128K:

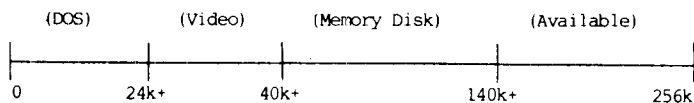

If you are in PCjr mode and try to install the Memory Disk device driver (MDSKDMA2.SYS) without specifying the Expanding Memory device driver (JRVIDMA2.SYS), only about 88K bytes of memory are available because of DOS and the PCjr video buffer. You **MUST** install the Expanded memory device driver to take advantage of any expanded memory. JRVIDMA2.SYS must be installed ahead of MDSKDMA2.SYS in your CONFIG.SYS file.

F. How to Create/Edit the DOS Configuration File

To install any device driver to your DOS working diskette(s) you must create the DOS configuration file named CONFIG.SYS and specify the device driver filename following the characters "DEVICE=". To do this you can use any file editor such as EDLIN or Personal Editor. You can also create it from the keyboard using the DOS command "COPY CON: CONFIG.SYS". For more information on these topics refer to your DOS reference manual.

The file-name for the Expanded Memory device is JRVIDMA2.SYS
The filename of the Memory Disk device driver is MDSKDMA2.SYS.

An example of editing the DOS configuration file to create an 88K memory disk is as follows:

- | STEP | ACTION |
|------|---|
| 1. | Insert your DOS working diskette (with Racore files) into drive A and insert your Racore backup diskette into drive B. Close the doors. |
| 2. | Type COPY B: MDSKDMA2. SYS
Press ENTER.

You will see this on your screen:
A> |
| 3. | Type EDLIN CONFIG.SYS Press ENTER.
you will see this on your screen:
End of input file
* |
| 4. | Type 2i Press ENTER
You will see this on your screen:
2:* |
| 5. | Type DEVICE=MDSKDMA2.SYS /88
Press ENTER
You will see this on your screen:
3:* |
| 6. | Depress the CTRL key while depressing the C key. You will see this on your screen:
* |
| 7. | Type E Press ENTER
You will see this on your screen:
A> |
| 8. | Depress CTRL, ALT, DEL keys. |

The Memory Disk device driver is now installed on your DOS working diskette.

The next time you start your system with this DOS diskette, you will have an 88K byte disk located in your PCjr memory.

PC/PCjr Mode Switch

The toggle switch, located on the back of the **Racore** Side Assembly, above the printer connector, allows you to change the mode of your computer from PCjr to PC. The switch is operative only when the system is started (either power ON or System Reset).

Do not change the position of the switch after DOS has been loaded.

When the switch is pointed away from the computer (outward), the computer is in the PCjr mode. In this mode, the computer behaves exactly as shipped from IBM, with the exception that you have 2 disk drives instead of 1. And when using JRVIDMA2 you may use expanded memory if available. Use this mode when running PCjr programs.

When the switch is pointed toward the computer (inward), the computer is in the PC mode. In this mode the computer behaves like a PC. Also, if there is more than 64K of system memory, the display is initialized to 80 column. Use this mode when running PC programs.

Experimenting with the different switch settings and available modes may allow additional software compatibility and will not cause software hardware errors if accidentally powered on a "wrong" switch setting.

Cartridge Basic

Your Basic Cartridge is designed to operate with 64K of Memory, **Racore** recommends operating your system in standard jr mode when running Basic.

Clock/Calendar

Introduction

The **Racore Drive Two Plus** contains a clock/calendar with battery backup which maintains the date and time while the power is on or off. This section contains information on use of **Racore** software for the proper operation of the **Racore** Clock/Calendar. The diskette shipped with the **Racore Drive Two Plus** contains 2 files used to operate the **Racore** Clock/Calendar. **POWDCLK2.EXE** and **SETDCLK2.EXE**.

POWDCLK2

The Disk Operating System (DOS) for your PCjr uses the DOS system clock for various system operations. Whenever you power on your PCjr, the DOS system clock must be set. To set the DOS system clock from the **Racore** Clock/Calendar, you must execute the program **POWDCLK2**. This is easily accomplished by adding the **POWDCLK2** command to your **AUTOEXEC.BAT** batch file (see **IBM DISK OPERATING SYSTEM MANUAL**).

SETDCLK2

This program is used to set the date and time of your **Racore** Hardware Clock. When **SETDCLK2** is loaded and ready, you will see something similar to this on your screen:

Current date is 9-30-1982

Enter new date:

Enter a new date in the form MM-DD-YY, where:

MM is a one- or two-digit number from 1 to 12 (representing month)

DD is a one- or two-digit number from 1 to 31 (representing day)

YY is a two-digit number from 80 to 99 (the 19 is assumed) or a four digit number from 1980 to 2099 (representing year)

If you enter an invalid date or delimiter, on your screen you will see:

Invalid date

Enter new date:

Note: To leave the date as is, press the ENTER key.

After you have entered a valid date, you will see something similar to this on your screen:

Current time is 14:43:50

Enter new time:

Enter a new time in the form HH:MM, where:

HH is a one- or two-digit number from 0 to 23 (representing hours)

MM is a one-or two-digit number from 0 to 59 (representing minutes)

Parallel Printer Port

Introduction

The **Racore Drive Two Plus** contains a parallel printer port. This section contains information on the use of additional parallel printer ports, the type of the printer cable to use, and where to refer if you are using a serial printer.

Printer Ports

As shipped, the **Racore** Parallel Printer Port needs no software to operate as printer device PRN or LPT1. The printer port may also be configured as printer device LPT2 by changing the base I/O address from Hex 378 to Hex 278 (see **Address Considerations** section of this manual).

Printer Cable

The configuration of the **Racore** Parallel Printer Port is a standard Centronics connection (which is the same as the IBM PC). Any IBM PC or compatible printer cable should work with your **Racore** Parallel Printer Port.

Using a Serial Printer

If you are using a serial printer, you should use the serial port on the IBM PCjr. When the serial port is going to be the primary port used, you must refer to the IBM DOS book under MODE.COM or MODE LPT1 for correct operations.

Address Considerations For The Racore Drive Two Plus

As shipped, the **Racore Drive Two Plus Package** uses 4K bytes of memory address space at hexadecimal address C8000 (C8000 to C8FFF), 32 bytes of memory space from CA000 to CA01F and 4 bytes of I/O address space at hexadecimal address 378 (378 to 278). If you have other addon devices, check the memory and I/O addresses of the other devices for contentions. If no contentions exist, there is no need to change the addressing of the **Racore Drive Two Plus**; however, if another addon device uses addresses that the **Racore Drive Two** also uses, you must change the address at which the **Racore Drive Two Plus** responds, or change the address at which the other addon responds.

The following is a step by step set of instructions for changing the base address of the **Racore Drive Two Plus**:

- 1** Turn your **Racore Drive Two Plus Side Assembly** so that the 2 plastic connectors are away from you. Remove the 4 mounting screws from the plastic case.

- Turn your **Racore Drive Two Plus** Side Assembly so that the 2 plastic connectors are toward you. Insert a flat-blade screwdriver into the slots between the front and back covers and pry the two apart.

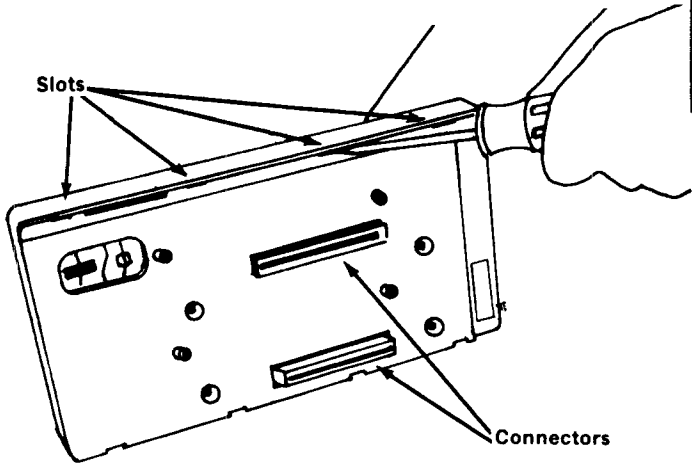

- Remove the printed circuit board from the plastic case.

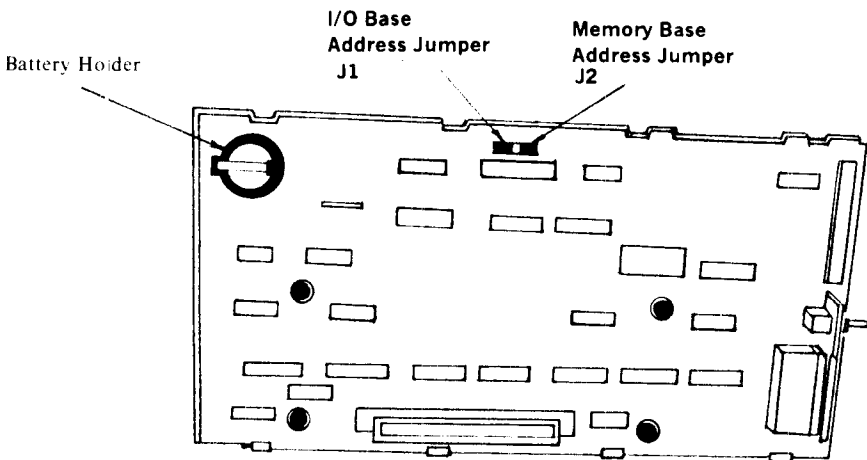

- 4** Change the position of jumpers, J1 or J2, as follows:

Memory Address

As shipped, the memory base address of the **Racore Drive Two Plus** is at hexadecimal address C8000 you may change the base address to hexadecimal address, CC000, by changing the position of jumper, J2.

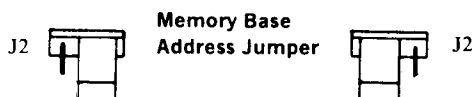

Memory Base Address
C8000 Hexadecimal

Memory Base Address
CC000 Hexadecimal

I/O Address

As shipped, the base I/O address of the **Racore Drive Two Plus** is at hexadecimal address 378. You may change the base address to 1 of 2 different hexadecimal addresses, 378 or 278, by changing the position of jumper, J1.



I/O Base Address
378 Hexadecimal

I/O Base Address
278 Hexadecimal

- 5** Replace the printed circuit board in its plastic case.
- 6** Press the front and back covers together.
- 7** Reinstall the 4 mounting screws.

Racore Software Commands

This section defines and describes the use of all **Racore Drive Two Plus** software commands. These commands use the same format notation as the IBM PC-DOS commands. If you have questions about the proper syntax, please refer to the DOS Command section of your PC-DOS manual.

JRDMAON2 Command

Purpose: Enables DMA operation in JR MODE.

Format: JRDMAON2

Remarks: This command enables the PCjr to operate with DMA in JR MODE. Some programs written specifically for the PCjr do not allow for DMA operation. To keep the machine completely compatible with these programs, DMA is not enabled in JR MODE unless this program is executed.

JRVIDMA2.SYS

- Purpose:** This file sets the operating parameters for the video and memory usage in JR MODE.
- Format:** DEVICE = JRVIDMA2 (/E) (/C)
- Remarks:** This file is a device driver. It can only be used from within a CONFIG.SYS file. When this file is placed in the CONFIG.SYS file, the PCjr loads it into memory and uses the specified parameters to customize the video and memory operation.

If no parameter is specified, a 16K video buffer is created. This allows for operation of all text modes, and the following graphics modes: 160X200 16 color, 320X200 4 color, and 640X200 2 color. This is the normal operating mode of the PCjr.

/E This parameter is called the Enhanced mode. It creates a 32K video buffer. This allows for all of the modes described in the above paragraph and in addition will allow 320X200 16 color and 640X200 4 color graphics modes.

/C This parameter is called the Compatible mode. This mode provides a 96K video buffer. The graphic modes are the same as described in the /E section. The advantage of this mode is that the entire lower 128K of memory is now used by DOS and the video buffer. This means that any programs that are loaded into memory will be placed in the expansion memory and will run up to 3.5 times faster.

Only one mode may be selected at a time. Remember, this is a device driver and not an executable file. It must be placed in the CONFIG.SYS to operate, and only operates in the JR MODE. The PC MODE equivalent programs are PCVIDMA2 and SPEEDMA2.

Note: Since this file only functions in the JR MODE, if you try to execute it in the PC MODE (i.e. it may be in your CONFIG.SYS file) it will not have any affect on the operation of your PCjr and will not interfere with operation.

MDSKDMA2.SYS

- Purpose:** Allows for the creation of a Memory Disk.
- Format:** DEVICE = MDSKDMA2 (/xxx)
- Remarks:** This file is a device driver. It is not directly executable from DOS. The command line as given in the Format line above must be installed in the CONFIG.SYS file.

/xxx The xxx is to be replaced with a number that represents the size (in K bytes) of the memory disk. The Minimum size is 24K bytes and the Maximum is 512K bytes (The actual maximum is determined by the amount of free user memory.) The default is 64K.

This device driver may be inserted more than once in the CONFIG.SYS file and will create a Memory Disk for each time that the command is inserted.

Example:

```
DEVICE = MDSKDMA2 /64  
DEVICE = MDSKDMA2 /128
```

The above lines, if inserted in the CONFIG.SYS file of a system with two floppy disk drives, will create two memory disks. The first will be drive C: and be 64K bytes. The second will be drive D: and be 128K bytes. These drives may be used just as the floppy disk drives are, however the data will be lost when power goes off.

PARK Command

Purpose: This command is used to prepare Hard File drives for transportation. This command is only useful on the **Racore 10MB Fixed Disk Product**.

Format: PARK

Remarks: Hard disk drives are precision devices. Vibration between the head and the disk can destroy the drive. The park command causes the head to be positioned at the special place on the disk where it will be less susceptible to damage. Prior to transportation of the Hard Drive, enter the park command and then turn the power off immediately after it finishes executing.

The PARK File should always be executed prior to powering the system off. If the drive is ever powered off without executing PARK, there is a possibility of damaging both the drive heads and hard drive platters if bumped or moved.

PCVIDMA2

Command

Purpose: This command is used to modify the video buffer in the PC MODE

Format: PCVIDMA2

Remarks: The PCjr is designed so that the video buffer is positioned at the high end of the internal 128K of memory. If you add extra expansion memory to the PCjr, this video buffer will create a "hole" in the useable memory. Executing PCVIDMA2 will move the video buffer down next to DOS and all application programs will load above this. Racore recommends using this command when ever you operate in the PC MODE. **Note:** If you attempt to load a program from disk and notice that the screen is being filled with colored boxes and strange characters, this is an indication that you probably should execute the PCVIDMA2 command prior to loading the program.

Note: Since this file only functions in the PC MODE, if you try to execute it in the JR MODE (i.e. it may be in your AUTOEXEC.BAT file) it will not have any affect on the operation of your PCjr and will not interfere with operation.

POWDCLK2

Command

Purpose: This program is used to set the DOS time and date clock from the hardware clock in the **Racore Drive Two Plus**.

Format: POWDCLK2

Remarks: Executing this command will read the current time and date from the battery powered clock in the **Racore** Side Assembly and set the DOS clock with this information. This will allow DOS to correctly "date stamp" all files without forcing the user to enter the correct time and date after every boot up.

Note: **Racore** recommends that this file be part of your AUTOEXEC.BAT file.

READ.ME

- Purpose:** This is a document file that contains information useful to the user.
- Format:** TYPE READ.ME
- Remarks:** This file is for information only. It is not an executable file. Often there are suggestions, helpful instructions or even new software programs created that are not documented in the manual because of the time required to re-publish the manual. The File READ.ME is used to pass that information on to you, the user. You may find it helpful to print the file, if you desire to add the information contained therein to your manual.

SETDCLK2

Command

Purpose: This command is used to initialize the time and date in the hardware clock in the **Racore Side Assembly**.

Format: SETDCLK2

Remarks: Entering the above command line will produce a prompt that displays the current date and requests the user to enter the current date as shown below:

Current date is XX-XX-XX

Enter new date:

Enter a new date in the form: MM-DD-YY

MM is a one or two digit number from 1-12 representing the current month.

DD is a one to two digit number from 1 to 31 representing the current day.

YY is a two digit number from 80 to 99 (the 19 is assumed) or a 4 digit number from 1980 to 2099 representing the current year.

If the current date as displayed by the prompt is correct, you may press enter to leave it unchanged.

Next you will be prompted with the current time in the machine and asked to enter the correct time is below:

Current time is XX:XX:XX

Enter new time:

Enter a new time in the form HH:MM where:

HH is a one or two digit number from 0 to 23 representing hours.

MM is a one or two digit number from 0 to 59 representing minutes.

If the time displayed by the prompt is correct, you may press the enter key to leave the time unchanged.

SPEEDMA2

Command

Purpose: This program is used to increase the operating speed of the PCjr.

Format: SPEEDMA2

Remarks: Because the internal 128K of memory in the PCjr is used as the display memory and the program memory at the same time, the PCjr runs slower because it has to share this memory between two functions. Execution of the command SPEEDMA2 reserves the lower 128K of memory for use by DOS, Device Drivers and the Video Buffer. This will then cause all application programs to load above this reserved area of memory and will allow the program to execute faster. This command only functions in the PC MODE and is equivalent to JRVIDMA2 with the /C option in JR MODE.

Note: Since this file only functions in the PC MODE, if you try to execute it in the JR MODE (i.e. it may be in your AUTOEXEC.BAT file) it will not have any affect on the operation of your PCjr. and will not interfere with operation.

Note: It is not necessary to run PCVIDMA2 if you run SPEEDMA2.

Racore Error Messages

HARDWARE CLOCK ERROR

Explanation: POWDCLK2. An invalid date or time was read from the **Racore** Clock/Calendar.

Action: Reset the **Racore** Clock/Calendar by executing SETDCLK2 and then turn the power off. Restore power to the system. If the error occurs again, replace the clock-calendar battery. If the problem persists, contact place of purchase for service information.

Invalid Date

Explanation: SETDCLK2. An invalid date or delimiter was entered. The only valid delimiter in a date entry is a hyphen (-).

Action: Re-enter valid date.

Invalid Time:

Explanation: SETDCLK2. An invalid time or delimiter was entered. The only valid delimiter in a time entry is a colon (:).

Action: Re-enter valid time.

BATTERY REPLACEMENT

The clock battery is located on the sideboard assembly. The silver battery (similar in size and shape to a 25c piece) may be slid out from under the holder and replaced by a **Panasonic CR2032** battery.

The clock must be reset after battery replacement.

RACORE CLOCK NOT PROPERLY INSTALLED

Explanation: The **Racore** Clock/Calendar was not found.

Action: Check for the following, then retry the command:

- Check to make sure that the **Racore Drive Two Plus** is installed properly (see **INSTALLATION INSTRUCTIONS**).
- Check to make sure that no other devices are at same I/O address as the **Racore Drive Two Plus** (see **Address Considerations for the Racore Drive Two Plus**).

If the problem persists, contact place of purchase for service information.

RACORE PRINTER NOT PROPERLY INSTALLED

Explanation **Racore** Parallel Printer Port Drivers. The **Racore** Parallel Printer Port was not found.

Action: Check for the following then retry driver installation:

- Check to make sure that the **Racore Drive Two Plus** is installed properly (see **INSTALLATION INSTRUCTIONS**).
- Check to make sure that no other devices are at the **Racore Drive Two Plus Address** (see **Address Considerations for the Racore Drive Two Plus**).

If the problem persists, contact place of purchase for service information.

PCjr ERROR MESSAGES

Error A:

Memory Error at the Location where the memory count has stopped. If the count is above 128K, the error is in the additional memory. Check for loose or bad connections. If the memory stops at 384K or above, check for loose or damaged additional memory chips.

Error B:

Keyboard error, caused by typing prior to full system boot. Reset the system and try again.

Error C:

Cartridge slot error, remove or reseal any installed cartridges and try again.

Error F:

ROM Error, generally this is caused by a defective EPROM chip and must be returned for service.

Error H:

Hardware error when **Racore** is attached- usually a bent pin in the IBM JR expansion side port or bad transformer connection (remember you need two black transformers) if this error continues, check system voltages or return product for servicing.

Testing Procedures for Transformers and Racore Power Supply for Proper Voltages.

Transformers

The IBM and **Racore** Transformers are interchangeable and should both provide the same approximate voltages. Insert the VOM Meter Leads into the two outside holes and test transformers for **18VAC+** or **-2V**.

Racore Power Supply

Test the **Racore** Power Supply after determining that all connections are correct, both transformers have been applied. Test points are at the base of each of the two cables soldered to the Printed Circuit Board. The correct DC Voltages are **+5VDC, +12VDC & GND**.

SERVICE/REPAIR RETURNS

All return items require a **RETURN AUTHORIZATION NUMBER (RA#)** This number is obtained through our Technical Service Department.

Items shipped without an RA# risk misplacement or refusal by the Shipping/ Receiving Department.

Please write your RA# clearly on the outside of your package.

Include your proof of purchase for units to be covered under **Racore Warranty**.

All non-warranty repairs or service will have a minimum charge of \$50.00

You are responsible for shipping charges to **Racore**.

Racore ships back by United Parcel Service (ground).

Racore Products For Your Pcjr

The following is a list of additional **Racore** products you will find useful in the operation of your PCjr. If you would like to order any of these products, or need additional information about any **Racore** PCjr product, please contact the **Racore Marketing/Sales Office**.

RACORE DRIVE TWO PLUS DMA OPTION

If your current version of the Drive Two Plus does not have DMA installed you may purchase this as an option. It will allow you to type on the keyboard while the disk drives are running, allow you to operate a modem at 1200 baud, and may increase operating speed of some disk intensive programs. (Order Model #1502)

RACORE 10/20MB FIXED DISK

This package will add 10/20 Megabytes of disk storage to your PCjr. This is the equivalent of 30/60 floppy disks in the system at one time. This hard disk will load and save programs several times faster than the floppy disk drives. Addition of this package to your PCjr will yield a machine comparable to the IBM XT. (Order Model #1511 or #1521)

RACORE 256K/512K MEMORY EXPANSION

This memory board plugs inside the Drive Two expansion chassis and allows the expansion of your PCjr memory up to the 640K memory limit. Now that you have the Drive Two, this is by far the least expensive way to add expansion memory. You may also purchase this memory board in the 256K version and later order the additional memory chips to increase it to the 512K limit. (Board Order Model #2101), (Chips Order Model #2102)

RACORE KEYBOARD ADAPTER

This product replaces the IBM keyboard cord for attaching the I.R. keyboard to the PCjr. In addition, the Keyboard Adapter allows the user to attach a big, full size IBM PC keyboard to the PCjr. You can even use both PC and PCjr keyboards at the same time. (Order Model #3200)

RACORE PC ID CARTRIDGE

Each IBM computer has a "Family ID Byte" in the ROM. Some software programs now look at that byte to decide what kind of machine it is running on (i.e. PC, XT, AT, PCjr). This cartridge changes the ID byte in the PCjr to look like a PC. Changing this byte allows some programs to operate on the PCjr that normally do not. For example, use of this cartridge allows you to use the Basic Programming language included in DOS without a cartridge. Also runs Copyiipc. (Order Model #3400)

RACORE AUDIO AMP AND SPEAKER

If you operate your PCjr with a composite video monitor or other monitor that doesn't have a speaker, you may provide your PCjr with the ability to use its sophisticated sound capabilities by using this audio amp and speaker. It mounts inside your PCjr and provides excellent sound. (Order Model #3100)

RACORE INTERNAL FAN

Your **Racore** product is guaranteed to operate in all normal environments without the aid of extra cooling. Some users have special needs that will require extra cooling. **Racore** can provide you with an internally mounted fan that will provide that extra cooling for those harsh operating requirements. (Order Model #3500)

NOTICE

POSSIBLE PROBLEM WITH PCjr AND RACORE DMA PRODUCTS

During the early shipments of Racore DMA products a pattern of problems developed where IBM PCjr's worked fine before the addition of the Racore DMA product and the Racore product worked well in our final test and on other PCjr's. Investigation of the problem revealed that about 10% of the PCjr's have a problem with some of the signal lines used for operation of the DMA product but not used in the PCjr as shipped from the factory. The problem appears to be one that happens to the PCjr after it leaves IBM's factories and only becomes a problem when the user attempts to add DMA to enhance the operation of the PCjr. Correction of the problem is quite simple. The procedure for determining if your PCjr has a problem and how to fix it are described in the steps that follow:

- 1** How to Check For the Problem.
 - A. First remember that this only affects machines that will be using the DMA. You will find the added convenience and increased speed of the DMA option will justify the 5 minutes needed to correct those machines that have a problem. Also remember that this only affects a small percentage of the PCjr's.
 - B. Complete the assembly of your PCjr and the Racore DMA option as outlined in the manuals included with your Racore product. You may proceed to turn the machine on. If this problem does exist in your PCjr, it will not harm the PC jr or the RACORE product to turn on the power. If the machine doesn't work, please recheck the assembly instructions to verify it is assembled correctly. Incorrect assembly is one of the most common problems handled by our field service department. If the machine still fails to operate, proceed to check for a short as outlined below.
 - C. Make sure that your PCjr and all options are turned off and disconnected from the 110V AC electrical outlets. Remove the plastic panel on the side of the PCjr that covers the I/O expansion port (See PCjr manuals for details).

D. Obtain an OHM meter or continuity checker. (If you don't have one, you might borrow one as they are quiet common. You might be able to borrow one from your computer dealer or a fellow computer user. If you can't find one, you may arrange to borrow one from Racore by calling Field Service.) Use figure 1 to locate pins A14 and B12 on the side I/O expansion port. If the continuity checker indicates a closed circuit or if the OHM meter indicates less than 100 Ohms between these two pins, your PCjr has a problem. If your PCjr has a problem go to step 2, if not proceed to look for another cause of malfunction noted in step 1B.

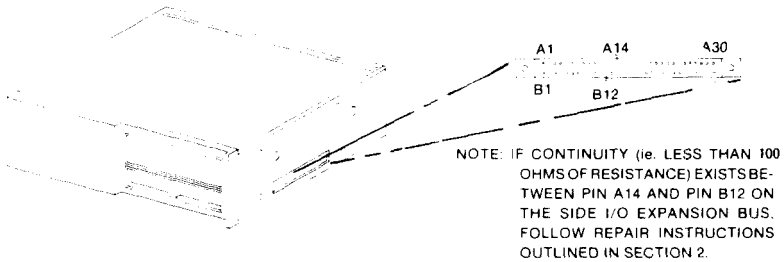

FIGURE 1

2 How to Fix the Short Circuit Found in Step 1D

- A. The first option is to return the PCjr to your dealer or IBM repair facility. If the machine is still under warranty, they should repair it for you. Racore has notified and documented the problem to the IBM PERSONAL COMPUTER CUSTOMER RELATIONS group in Florida, so your dealer or IBM repair department should be aware of the problem. If your machine is no longer under warranty, you might still ask them about repair as IBM is very conscious about customer satisfaction. Please be sure that you have completed the steps in part 1 and are sure that there is really a short on the PCjr board. Repair departments will become less co-operative if they get a lot of false claims. It will be helpful if you take this document to your repair facility with your PCjr.
- B. The next option is to take the machine to any computer repair shop. If you deliver this document to them along with your PCjr guide to operations, they should be able to repair the problem by following the steps in part 2D at a very minimal cost.
- C. If neither of the above options is available to you and you don't feel up to repairing the problem yourself as outlined in section 2D, you may contact Racore about a repair. Unfortunately, since the problem is one with the PCjr and not with the Racore product, Racore will not be able to repair it under a Racore Warranty. Contact Racore Field Service for details on the cost of repair and repair time estimates.
- D. If you feel the above options are not the solution and desire to fix the problem yourself, you will find it is not too difficult if you are careful. Racore would again suggest you consider step 2A before starting the repair. To begin, remove the Racore option you have just installed by reversing the installation instructions. Next, look in the PCjr GUIDE TO OPERATIONS. This manual contains a section about installing the disk drive, modem, power supply and memory expansion into the PCjr case. Reverse these steps to remove all of these options from the PCjr. Using a flat-blade screwdriver, remove the 5 screws that secure the motherboard to the plastic case. Four of these are located near the rear of the case by the external options connectors and the fifth one is located near the cartridge slots. The next step is to CAREFULLY unhook the board

from the two plastic catches on the left side of the case. These are easy to break so you must be very careful not to press them back to far. Remove the motherboard from the plastic case and look at the bottom or solder side of the board. Using figure 2, locate the area indicated and look for the short. It will be a small peice of metal connecting the two indicated circuits. Also check for a small peice of metal on the plastic support in the case that is located directly below the connector indicated in the drawing. After removing the metal flakes from the connector area, again check for the short circuit as described in section 1D. If you have fixed the problem, the test should now indicate there is no longer a problem. Re-assemble the entire computer by reversing the dis-assembly instructions.

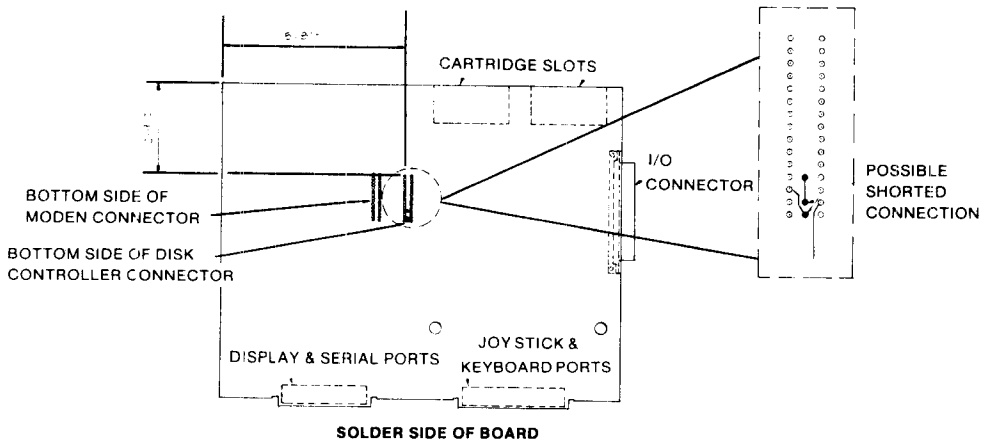

FIGURE 2

Racore Computer Products

Limited Warranty

Racore Corporation warrants their products to be in working order for a period of one year from the date of original purchase. Should a Racore product fail to be in working order during this one year period, Racore will repair or replace that product, at its option, at no charge except as set forth below. Replacement products or repair parts will be furnished on a replacement basis and will be either new or reconditioned. Service to repair damage to the product resulting from accident, misuse, disaster or non-Racore modifications to the product is not covered by this limited warranty.

Limited Warranty service may be obtained by mailing the product and proof of purchase to: Racore Computer Products, 2070 N. Redwood Road, Salt Lake City, Utah 84116. If you mail the product, you insure the product or assume risk of loss or damage due to shipping. You also assume the cost of shipping to Racore Computer Products.

All express and implied warranties for this product including the warranties of merchantability and fitness for a particular purpose, are limited in duration to a period of one year from the date of original purchase, and no warranties, whether express or implied, will apply after this period. Some states do not allow limitations on how long an implied warranty lasts, so the above limitations may not apply to you.

If this product is not in good working order as warranted above, your sole remedy shall be repair or replacement as provided above. In no event will Racore be liable to you for any damages, including lost profits, lost savings or other incidental or consequential damages arising out of this use of or inability to use such product, even if Racore or an authorized Racore dealer has been advised of the possibility of such damages, or for any claim by any other party.

Some States do not allow the exclusion of limitation of incidental or consequential damages for consumer products, so the above limitation or exclusions may not apply to you.

This warranty gives you specific legal rights, and you may also have other rights which may vary from State to State.

Racore Companions™ 256/512 KB Memory Expansion Package (Model 2101)

Installation Instructions

Note: This accessory requires a **Racore Companions Drive Two Enhancement Package, 10MB Fixed Disk or Racore Drive Two Plus.**

CAUTION

Please read entire Manual before attempting to use this product with other Memory Expansion Boards, especially the section about the Memory Configuration Jumper or you could cause damage to your system.

256/512KB Memory

Installation of Racore 256/512 KB Memory Expansion Package

The following is a step by step set of instructions for installation of the **Racore 256/512 KB Memory Expansion Package**.

- 1** Remove the **Racore Disk Drive Enhancement Package** from your PCjr (see **Racore Drive Two, 10MB Fixed Disk or Racore Drive Two Plus** installation instructions).
- 2** Plug the **Racore Memory Expansion Board** and **Extender Card** connectors together so that the **Extender Card** edge connector points away from the **Memory Board**; be careful not to bend or otherwise damage the connectors or pins inside the connectors.
- 3** Position the **Racore Extender Card** in the **Extender Card Slot** as shown. (fig. 1)

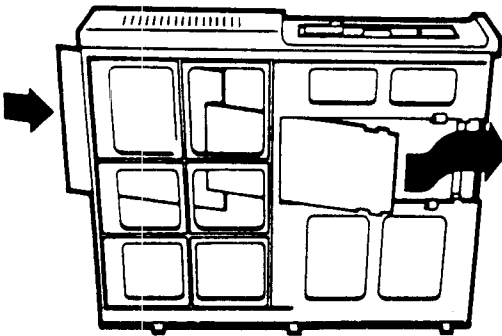

fig. 1

4 The **Racore** Memory Board should be held in place at its outer edge via two plastic flanges. (fig. 2)

5 Snap the **Racore** Extender Card into place.

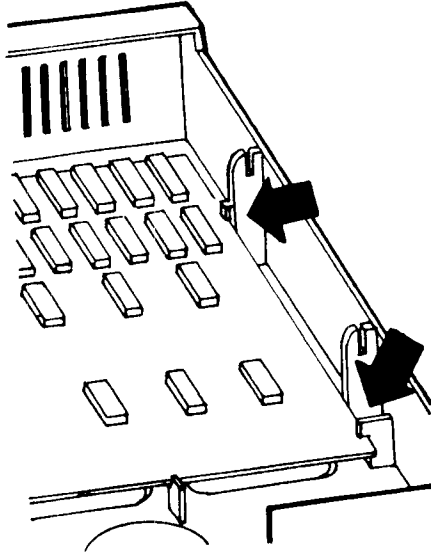

fig. 2

Add-In Memory

If you purchased the 256KB version of the **Racore** Memory Expansion, you may upgrade to 512KB by purchasing and installing eight (8) additional 256KB Memory Chips.*

With all power switched "OFF," remove the computer cover. The component side should be facing up and you should see a row of open sockets. Insert your additional Memory Chips into these sockets.

Note that your new chips will have an orientation mark on top—either a semi-circular etching, a white dot or a color bar. Whatever orientation mark your chips have, make sure that it corresponds with the position of the semi-circular etching on it's socket and the orientation of the other Chips on the Board.

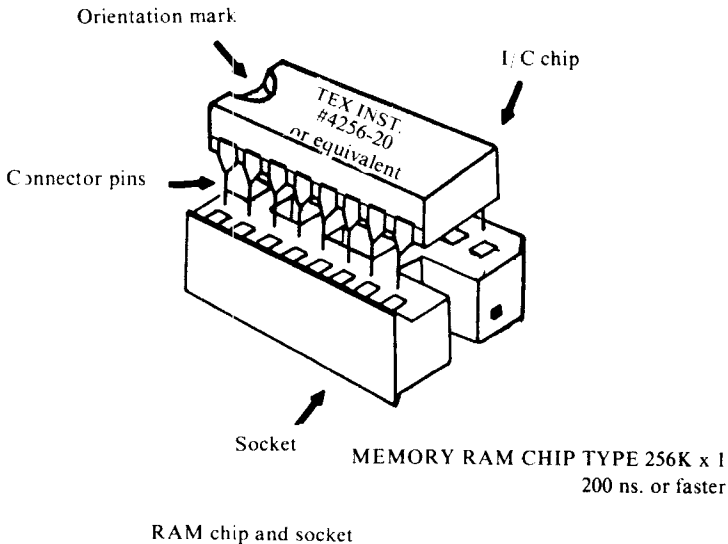

* 3 chip sets are available for purchase from **Racore**. When ordering refer to Model #2102

Memory Configuration Jumper

Your **Racore 256/512KB Memory Expansion Card** is designed to be the only Memory Expansion Board needed to expand your PCjr to the maximum 640 KB of Memory allowed in the IBM PCjr family.

Some PCjr users also desire to add other peripheral adapters to their PCjr such as a Mouse or additional Parallel Port. Some of these include additional RAM in the adapter.

To allow for use of these adapters with the **Racore** Memory Expansion Unit, a jumper is provided on the Memory Board. This only applies to fully loaded 512KB Memory boards.

With jumper in Position 2 as shipped from the factory, your PCjr is able to address and use all 512KB of Memory on the **Racore** Memory Board, giving a total of 640KB of Memory.

If the jumper is moved to Position 1, your PCjr will not be able to access the Top 128KB of Memory on the **Racore** Memory Board. This will allow you to set the Configuration Option on your other Adapter Board to run in this position (i.e. between Memory Address 512KB and 640KB.)

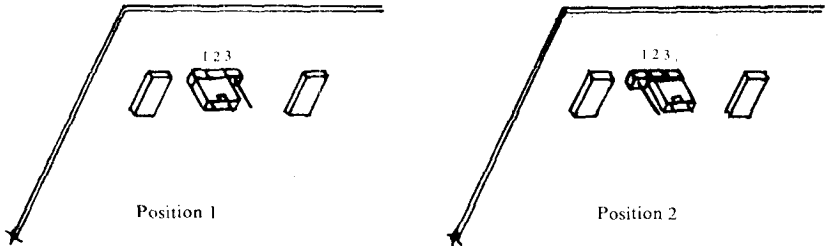

Note:

If you have purchased a **Racore** DMA Product, please note that DMA can only work using **Racore** Memory Expansions. If you have an additional Adapter with Memory, you must follow the above procedure, setting the address of your Adapter Memory to the 512KB-640KB Memory Range. In addition you must remove the memory from your Adapter. Removing the Memory in the Adapter is required so that the DOS does not try to use that Memory (errors can occur because of timing). Setting the jumper allows a space for it in the Memory Mapping.

6

Reassemble your PCjr and turn on power.